

aerospace  
climate control  
**electromechanical**  
filtration  
fluid & gas handling  
hydraulics  
pneumatics  
process control  
sealing & shielding

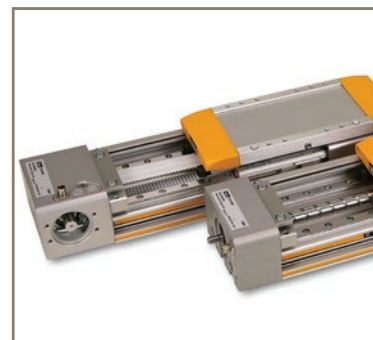

# Electromechanical Linear Actuators

Product Overview



ENGINEERING YOUR SUCCESS.



**WARNING – USER RESPONSIBILITY**

**FAILURE OR IMPROPER SELECTION OR IMPROPER USE OF THE PRODUCTS DESCRIBED HEREIN OR RELATED ITEMS CAN CAUSE DEATH, PERSONAL INJURY AND PROPERTY DAMAGE.**

- This document and other information from Parker-Hannifin Corporation, its subsidiaries and authorized distributors provide product or system options for further investigation by users having technical expertise.
- The user, through its own analysis and testing, is solely responsible for making the final selection of the system and components and assuring that all performance, endurance, maintenance, safety and warning requirements of the application are met. The user must analyze all aspects of the application, follow applicable industry standards, and follow the information concerning the product in the current product catalog and in any other materials provided from Parker or its subsidiaries or authorized distributors.
- To the extent that Parker or its subsidiaries or authorized distributors provide component or system options based upon data or specifications provided by the user, the user is responsible for determining that such data and specifications are suitable and sufficient for all applications and reasonably foreseeable uses of the components or systems.

<b>Parker Hannifin .....</b>	<b>4</b>
<b>Markets and Applications .....</b>	<b>8</b>
<b>Technical Features .....</b>	<b>10</b>
<b>Rod-Style Linear Handling Actuators .....</b>	<b>13</b>
ETH - High Force Electro Thrust Cylinder .....	14
ETT- Electric Tubular Motor .....	20
OSP-E..SBR - Ball Screw Actuator with Internal Plain Bearing Guide .....	24
OSP-E..STR - Trapezoidal Screw Actuator with Internal Plain Bearing Guide .....	27
<b>Rodless Linear Handling Actuators .....</b>	<b>31</b>
HPLA - Linear Actuator with Plastic-Sheated Rollers .....	32
HLE - Linear Actuator with Plastic-Sheathed Rollers.....	34
OSP-E..BHD - Belt Actuator with Integrated Ball Bearing and Roller Guide .....	38
OSP-E..B - Belt Actuator with Internal Plain Bearing Guide.....	41
OSP-E..SB - Ball Screw Actuator with Internal Plain Bearing Guide.....	44
OSP-E..ST - Trapezoidal Screw Actuator with Internal Plain Bearing Guide.....	46
OSP-E..BV - Vertical Belt Actuator with Integrated Ball Bearing Guide .....	48
LCB Compact Linear Actuator with Sliding Bearing .....	52
LCR - Light Capacity Rodless Miniature Linear Positioner .....	54
HMR - Electromechanical Linear Actuator.....	56
<b>Precision Positioners.....</b>	<b>65</b>
XE - Screw Driven Positioner .....	66
XR - Screw Driven Positioner .....	69
MX - Miniature Positioners.....	74
MX80M - Free Travel and Micrometer Driven Stages.....	78

# Parker Hannifin

## The global leader in motion and control technologies and systems

### Global Partnerships Global Support

Parker is committed to helping make our customers more productive and more profitable through our global offering of motion and control products and systems. In an increasingly competitive global economy, we seek to develop customer relationships as technology partnerships. Working closely with our customers, we can ensure the best selection of technologies to suit the needs of our customers' applications.

### Electromechanical Technologies for High Dynamic Performance and Precision Motion

Parker electromechanical technologies form an important part of Parker's global motion and control offering. Electromechanical systems combine high performance speed and position control with the flexibility to adapt the systems to the rapidly changing needs of the industries we serve.

aerospace  
climate control  
**electromechanical**  
filtration  
fluid & gas handling  
hydraulics  
pneumatics  
process control  
sealing & shielding



### Parker Hannifin Corporation

With annual sales exceeding \$13 billion in fiscal year 2014, Parker Hannifin is the world's leading diversified manufacturer of motion and control technologies and systems, providing precision-engineered solutions for a wide variety of mobile, industrial and aerospace markets. The company employs approximately 57,500 people in 50 countries around the world.

Parker has increased its annual dividends paid to shareholders for 58 consecutive fiscal years, among the top five longest-running dividend-increase records in the S&P 500 index.

For more information, visit the company's website at [www.parker.com](http://www.parker.com), or its investor information website at [www.phstock.com](http://www.phstock.com).

Issue: 08/2014



# Parker Hannifin

## The global leader in motion and control technologies

### A world class player on a local stage

#### Global Product Design

Parker Hannifin has more than 40 years experience in the design and manufacturing of drives, controls, motors and mechanical products. With dedicated global product development teams, Parker draws on industry-leading technological leadership and experience from engineering teams in Europe, North America and Asia.

#### Local Application Expertise

Parker has local engineering resources committed to adapting and applying our current products and technologies to best fit our customers' needs.

#### Manufacturing to Meet Our Customers' Needs

Parker is committed to meeting the increasing service demands that our customers require to succeed in the global industrial market. Parker's manufacturing teams seek continuous improvement through the implementation of lean manufacturing methods throughout the process. We measure ourselves on meeting our customers' expectations of quality and delivery, not just our own. In order to meet these expectations, Parker operates and continues to invest in our manufacturing facilities in Europe, North America and Asia.

#### Electromechanical Worldwide Manufacturing Locations

##### Europe

Littlehampton, United Kingdom  
Dijon, France  
Offenburg, Germany  
Filderstadt, Germany  
Milan, Italy

##### Asia

Wuxi, China  
Jangan, Korea  
Chennai, India

##### North America

Rohnert Park, California  
Irwin, Pennsylvania  
Charlotte, North Carolina  
New Ulm, Minnesota



Offenburg, Germany

#### Local Manufacturing and Support in Europe

Parker provides sales assistance and local technical support through a network of dedicated sales teams and authorized technical distributors throughout Europe.

For contact information, please refer to the Sales Offices on the back cover of this document or visit [www.parker.com](http://www.parker.com)



Milan, Italy



Littlehampton, UK



Filderstadt, Germany



Dijon, France

# Solutions to Improve Productivity, Increase Flexibility and Save Energy

## Process Productivity and Reliability

Parker brings together the technology and experience required for continuous process applications across many industries. Electromechanical and drive products combine application specific functionality to ensure precise speed control and reliable performance. Parker combines more than 30 years of application experience with a global sales and support network that help you increase your machine availability.

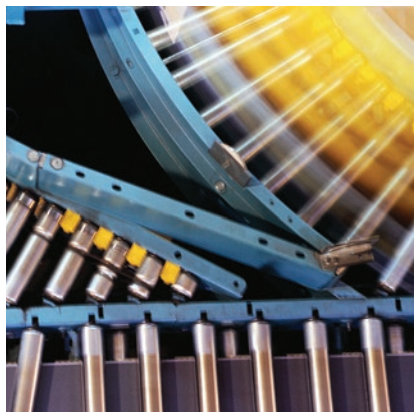

	AC-Drives	DC-Drives	Direct-Drive Motors	Servo Drives and Motors
<b>Converting machinery</b>				
Folding, gluing, stitching and collating	✓	✓		✓
Coating, laminating and foil stamping	✓	✓	✓	✓
Slitting, cutting and rewinding	✓	✓	✓	✓
<b>Plastics processing machinery</b>				
Plastic extrusion	✓		✓	
Injection moulding	✓		✓	✓
Thermal forming	✓		✓	✓
<b>Wire and cable</b>				
Wire and cable manufacturing	✓	✓		✓
Winding/unwinding	✓	✓	✓	
Extrusion for wire and cable	✓	✓	✓	
<b>Printing Machinery</b>				
Web/sheetfed offset	✓		✓	✓
Flexo printing	✓		✓	✓
Gravure printing	✓		✓	✓
Shaftless printing	✓		✓	✓
<b>Other industries</b>				
Paper machinery	✓		✓	
Sugar processing	✓	✓		
Steel production	✓	✓	✓	
Construction materials	✓	✓		
Automotive test rigs	✓	✓	✓	

## Energy Efficiency and Clean Power

Parker has developed the technology to maximize the efficient use of energy in industrial, mobile and infrastructure environments.

### Hybrid Vehicle Technology

Now having adapted it's technology for use in hybrid and electric vehicles, Parker offers solutions for:

- Electro Hydraulic Actuation
- Hybrid and Electric Vehicle traction
- Vehicle auxiliary systems



### Energy-savings for pumps, fans and compressors

Parker has the drive technology to help you make significant energy savings in the operation of pumps, fans and compressors in both industrial and infrastructure applications, including:

- Commercial refrigeration
- Water and wastewater treatment
- Building automation
- Industrial processes
- Hydraulic systems

### Power Generation and Conversion

Using proven inverter technology, Parker has developed numerous solutions for the conversion of energy for commercial use from a variety of sources, including wind, wave and energy storage devices.















# Motion Control Systems for Total Production Flexibility

Parker's electromechanical automation customers enjoy total production flexibility in their general and precision motion control applications. Complete packaged linear positioning systems, coupled to servo and stepper drives and controls, enable our customers to develop a complete motion solution with one partner. Parker provides the products for a wide range of motion needs- power, speed, travel, force-with easy to use controls designed to work on multiple control and communication platforms. Additionally, Parker's products can be easily customized to suit specific applications.



	Mechanical Actuators	Motors and Gearheads	Drives	Controls	HMI
<b>Assembly machinery</b>					
Pick and Place	✓	✓	✓	✓	✓
Lifting	✓	✓	✓	✓	
Transfer machinery	✓	✓	✓	✓	✓
<b>Automotive industry</b>					
Body shop	✓	✓	✓	✓	
Paintshop applications	✓	✓	✓	✓	✓
Transfer machinery	✓	✓	✓	✓	✓
<b>Packaging machinery</b>					
Primary, secondary, tertiary	✓	✓	✓	✓	✓
Handling machinery	✓	✓	✓	✓	✓
<b>Food and Beverage processing machinery</b>					
Processing machinery	✓	✓	✓	✓	
Packaging machinery	✓	✓	✓	✓	
Handling machinery	✓	✓	✓	✓	✓
<b>Material handling systems</b>					
Transfer systems	✓	✓	✓	✓	✓
Pick and place systems	✓	✓	✓	✓	✓
<b>Material forming machinery</b>					
Presses	✓	✓	✓		✓
Tube bending	✓	✓	✓	✓	✓
Die Casting	✓	✓	✓		✓
Injection Molding / Plastic Extrusion	✓	✓	✓		✓
Transfer Systems	✓	✓	✓	✓	✓
ePump (Variable Speed HPU)		✓	✓	✓	
<b>Machine tools</b>					
High Speed Servo Spindles		✓			
Loader/Unloader	✓	✓	✓	✓	
Palletizing/Transfer	✓	✓	✓	✓	✓
Rotary/Tilting Tables		✓			
Door Systems	✓	✓	✓	✓	
<b>Semiconductor machinery</b>					
Front end processes	✓	✓	✓	✓	✓
Inspection machinery	✓	✓	✓	✓	✓
Packaging machinery	✓	✓	✓	✓	✓
Lithography	✓	✓	✓	✓	
<b>Medical equipment</b>					
Device manufacturing	✓	✓	✓	✓	✓
Product packaging and dispensing	✓	✓	✓	✓	✓
Scanning equipment	✓	✓	✓		
Pumps and analyzers		✓	✓		
<b>Entertainment</b>					
Theatre and studio automation	✓	✓	✓	✓	
Simulation and amusement rides	✓	✓	✓		

# Markets and Applications

	Rod-Style Linear Handling Actuators				Rodless Linear Handling Actuators			
								
Product	ETH	ETT	OSP-E..SBR	OSP-E..STR	HPLA	HLE	OSP-E..B	OSP-E..SB
Description	High Force Electro Thrust Cylinder	Electric Tubular Motor	Ball Screw Actuator with Internal Plain Bearing Guide	Trapezoidal Screw Actuator with Internal Plain Bearing Guide	Linear Actuator with Plastic-Sheathed Rollers	Linear Actuator with Plastic-Sheathed Rollers	Belt Actuator with Internal Plain Bearing Guide	Ball Screw Actuator with Internal Plain Bearing Guide
Factory automation	<input type="checkbox"/>	<input type="checkbox"/>	<input type="checkbox"/>	<input type="checkbox"/>	<input type="checkbox"/>	<input type="checkbox"/>	<input type="checkbox"/>	<input type="checkbox"/>
Material handling	<input type="checkbox"/>	<input type="checkbox"/>	<input type="checkbox"/>	<input type="checkbox"/>	<input type="checkbox"/>	<input type="checkbox"/>	<input type="checkbox"/>	<input type="checkbox"/>
Material forming	<input type="checkbox"/>							<input type="checkbox"/>
Machines tools	<input type="checkbox"/>							<input type="checkbox"/>
Textile machines	<input type="checkbox"/>	<input type="checkbox"/>			<input type="checkbox"/>	<input type="checkbox"/>	<input type="checkbox"/>	<input type="checkbox"/>
Robotics	<input type="checkbox"/>	<input type="checkbox"/>					<input type="checkbox"/>	<input type="checkbox"/>
Packaging machines	<input type="checkbox"/>	<input type="checkbox"/>					<input type="checkbox"/>	<input type="checkbox"/>
Printing industry	<input type="checkbox"/>						<input type="checkbox"/>	<input type="checkbox"/>
Automotive industry / In-plant	<input type="checkbox"/>		<input type="checkbox"/>	<input type="checkbox"/>	<input type="checkbox"/>	<input type="checkbox"/>	<input type="checkbox"/>	<input type="checkbox"/>
Food, pharma & beverage	<input type="checkbox"/>	<input type="checkbox"/>	<input type="checkbox"/>	<input type="checkbox"/>				<input type="checkbox"/>
Life science (Medical instruments)	<input type="checkbox"/>	<input type="checkbox"/>	<input type="checkbox"/>	<input type="checkbox"/>	<input type="checkbox"/>	<input type="checkbox"/>		<input type="checkbox"/>
Life science (Diagnostic)			<input type="checkbox"/>	<input type="checkbox"/>				<input type="checkbox"/>
See details	(Page 14)	(Page 20)	(Page 24)	(Page 27)	(Page 32)	(Page 34)	(Page 41)	(Page 44)
Product catalogue	 192-550017	 192-571001	 P-A4P017GB	 P-A4P017GB	 192-580011	 192-510011	 P-A4P017GB	 P-A4P017GB



Rodless Linear Handling Actuators

Precision Actuators



OSP-E..ST	OSP-E..BV	OSP-E..BHD	OSP-E..BHD (BH2)	LCB	LCR	HMR-S	HMR-B	XE	XR	MX
Trapezoidal Screw Actuator with Internal Plain Bearing Guide	Vertical Belt Actuator with Integrated Ball Bearing Guide (z-axis)	Belt Actuator with Integrated Roller Guide	Belt Actuator with Integrated Ball Bearing Guide	Compact Linear Actuator with Sliding Bearing	Light Capacity Rodless Miniature Linear Positioner	Ball Screw Actuator with Integrated Double Ball Bearing Guide	Belt Actuator with Integrated Double Ball Bearing Guide	Screw Driven Positioner	Screw Driven Positioner	Miniature Positioner
■	■	■	■	■		■	■			
■	■	■	■			■	■			
		■	■			■	■			
		■	■			■	■			
■	■	■	■	■		■	■			
■	■	■	■			■	■			
	■	■	■			■	■			
■		■	■			■	■			
■		■	■			■	■			
■	■			■		■	■			
■						■		■	■	■
■					■			■	■	■
(Page 46)	(Page 48)	(Page 38)	(Page 38)	(Page 52)	(Page 54)	(Page 56)	(Page 56)	(Page 66)	(Page 69)	(Page 74)
P-A4P017GB	P-A4P017GB	P-A4P017GB	P-A4P017GB	192-510012	192-510100	P-A4P024GB	P-A4P024GB	192-540011	192-540012	192-590015

# Technical Features

## Rod-Style Linear Handling Actuators

## Rodless Linear Handling Actuators



Product	ETH	ETT	OSP-E..SBR	OSP-E..STR	HPLA	HLE	OSP-E..B	OSP-E..SB
<b>Description</b>	High Force Electro Thrust Cylinder	Electric Tubular Motor	Ball Screw Actuator with Internal Plain Bearing Guide	Trapezoidal Screw Actuator with Internal Plain Bearing Guide	Linear Actuator with Plastic-Sheathed Rollers	Linear Actuator with Plastic-Sheathed Rollers	Belt Actuator with Internal Plain Bearing Guide	Ball Screw Actuator with Internal Plain Bearing Guide
<b>Size for product family</b>	5	3	3	3	3	2	3	3
<b>max. Stroke* [mm]</b>	2000	720	500	500	9560	8230	5000	3200
<b>max. Thrust force* [N]</b>	114 000	118,5	1200	3300	5457	1350	425	1500
<b>max. Load* [N]</b>	-	-	-	-	8200	5900	850	3000
<b>max. Speed at stroke* [mm/s]</b>	1707	5800	1250	125	5000	5000	5000	1250
<b>max. Acceleration* [m/s<sup>2</sup>]</b>	15	339	5	na	10	10	10	5
<b>min. accuracy* [mm]</b>	±0,03	±0,05	±0,05	±0,5	±0,05	±0,05	±0,05	±0,05
<b>min. Repeatability* [µm]</b>	-	-	-	-	-	-	-	-
<b>IP Protection</b>	IP54 (IP65 optional)	IP67	IP54	IP54	IP20 (IP30 optional)	IP20	IP54	IP54
<b>See details</b>	(Page 14)	(Page 20)	(Page 24)	(Page 27)	(Page 32)	(Page 34)	(Page 41)	(Page 44)
<b>Product catalogue</b>	 192-550017	 192-571001	 P-A4P017GB	 P-A4P017GB	 192-580011	 192-510011	 P-A4P017GB	 P-A4P017GB

\* depending on size/option  
 n.a. not available

**Rodless Linear Handling Actuators**

**Precision Linear Actuators**



OSP-E..ST	OSP-E..BV	OSP-E..BHD	OSP-E..BHD (BH2)	LCB	LCR	HMR-S	HMR-B	XE	XR	MX
Trapezoidal Screw Actuator with Internal Plain Bearing Guide	Vertical Belt Actuator with Integrated Ball Bearing Guide (z-axis)	Belt Actuator with Integrated Roller Guide	Belt Actuator with Integrated Ball Bearing Guide	Compact Linear Actuator with Sliding Bearing	Light Capacity Rodless Miniature Linear Positioner	Ball Screw Actuator with Integrated Double Ball Bearing Guide	Belt Actuator with Integrated Double Ball Bearing Guide	Screw Driven Positioner	Screw Driven Positioner	Miniature Positioner
3	2	3	4	2	1	5	5	3	5	2
2500	1500	7000	7000	5500	1000	4000	6000	700	2000	200
2500	1490	3120	3120	560	70	5500	4000	686	4510	123
1500	3000	15000	15000	3850	90	39900	39900	1202	14400	80
150	5000	10000	5000	8000	900	1600	5000	1500	1344	2000
k.A.	20	40	50	20	20	10	50	20	20	50
±0,5	±0,05	±0,05	±0,05	±0,2	±0,1	±0,02	±0,05	±0,005	±0,0013	±0,0004
-	-	-	-	-	-	-	-	42	8	3
IP54	IP20	IP54	IP54	k.A.	k.A.	IP54	IP54	n.a.	n.a.	n.a.
(Page 46)	(Page 48)	(Page 38)	(Page 38)	(Page 52)	(Page 54)	(Page 56)	(Page 56)	(Page 66)	(Page 69)	(Page 74)
P-A4P017GB	P-A4P017GB	P-A4P017GB	P-A4P017GB	192-510012	192-510100	P-A4P024GB	P-A4P024GB	192-540011	192-540012	192-590015



# Rod-Style Linear Handling Actuators



ETH



ETT



OSP-E..SBR



OSP-E..STR



# High Force Electro Thrust Cylinder - ETH

## Overview

### Description

The ETH electro cylinder closes the gap between pneumatic and hydraulic actuators; it can act as a suitable alternative to both in many applications and can have the added benefit of increasing the reliability of the production process. Taking the costs for air and oil into consideration, you will find that in most cases an electromechanical system such as the ETH electro cylinder offers the more economical solution. Combined with a wide choice of accessories, the ETH becomes a highly customisable solution, suitable for a variety of applications.

### Typical applications



- **Material handling and feed systems**
  - wood working and plastics industries
  - vertical actuators for loading machine tools
  - in the textile industry for tensioning / gripping textile fabrics
  - in the automotive industry for transporting and feeding components
- **Testing equipment and laboratory applications**
- **Valve and flap actuation**
- **Pressing**
- **Packaging machinery**
- **Process automation in the food and beverage industry**

### Features

- **Unrivalled power density - high forces and small frame sizes**
- **Cabling can be concealed in the profile**
- **Accessories with integrated force sensors help to spread and even to control forces precisely**
- **Optimized for safe handling and simple cleaning**
- **High service life**
- **Reduced maintenance costs thanks to lubricating access in the cylinder flange**
- **Easy replacement due to pneumatic ISO flange norm (DIN ISO 15552:2005-12) conformity**
- **Integrated anti-rotation device**
- **Reduced noise emission**
- **All from one source:**  
 We offer the complete drive train: Drive controllers, motors and gearboxes to match the Electro Cylinder



## Technical Characteristics - Overview

Type	ETH Electro Cylinder
Frame sizes	ETH032 / ETH050 / ETH080 / ETH100 / ETH125
Screw lead	5, 10, 16, 20, 32 mm
Stroke	up to 2000 mm
Traction/thrust force	up to 114000 N
Speed	up to 1.7 m/s
Acceleration	up to 15 m/s <sup>2</sup>
Equivalent dynamic axial force at a lifetime of 2500 km	up to 49600 N
Efficiency	up to 90 %
Repeatability	up to ± 0.03 mm
Protection classes	IP54 IP54 with stainless screws IP65
Drive	Inline: Axial drive or parallel drive with high performance toothed belt
Directives	2011/65/EC: Conform to RoHS  RoHS 2014/34/EU (valid from 20. April 2016) 94/9/EC (valid until 19. April 2016) Equipment group II Category 2, authorized for gas atmospheres zone 1 and zone 2
Classification	ETH032, 050:  II 2G c IIC T4 ETH080, 100, 125:  II 2G c IIB T4 Conformity certificate number: EPS 13 ATEX 2 592 X (X: there are special specification of use, please observe the intended use of the ATEX Cylinder)

## We also offer customized solutions:

If your application requires a special version of the ETH cylinder, please contact your local Parker Sales Office.

- Oil splash lubrication
- Customized mountings and rod ends
- Mounting of customer motors
- Preparation of the cylinder for use under aggressive environmental conditions
- Overlong thrust rod
- Polished thrust rod
- Thrust rod hard-chrome plated

## Product Design

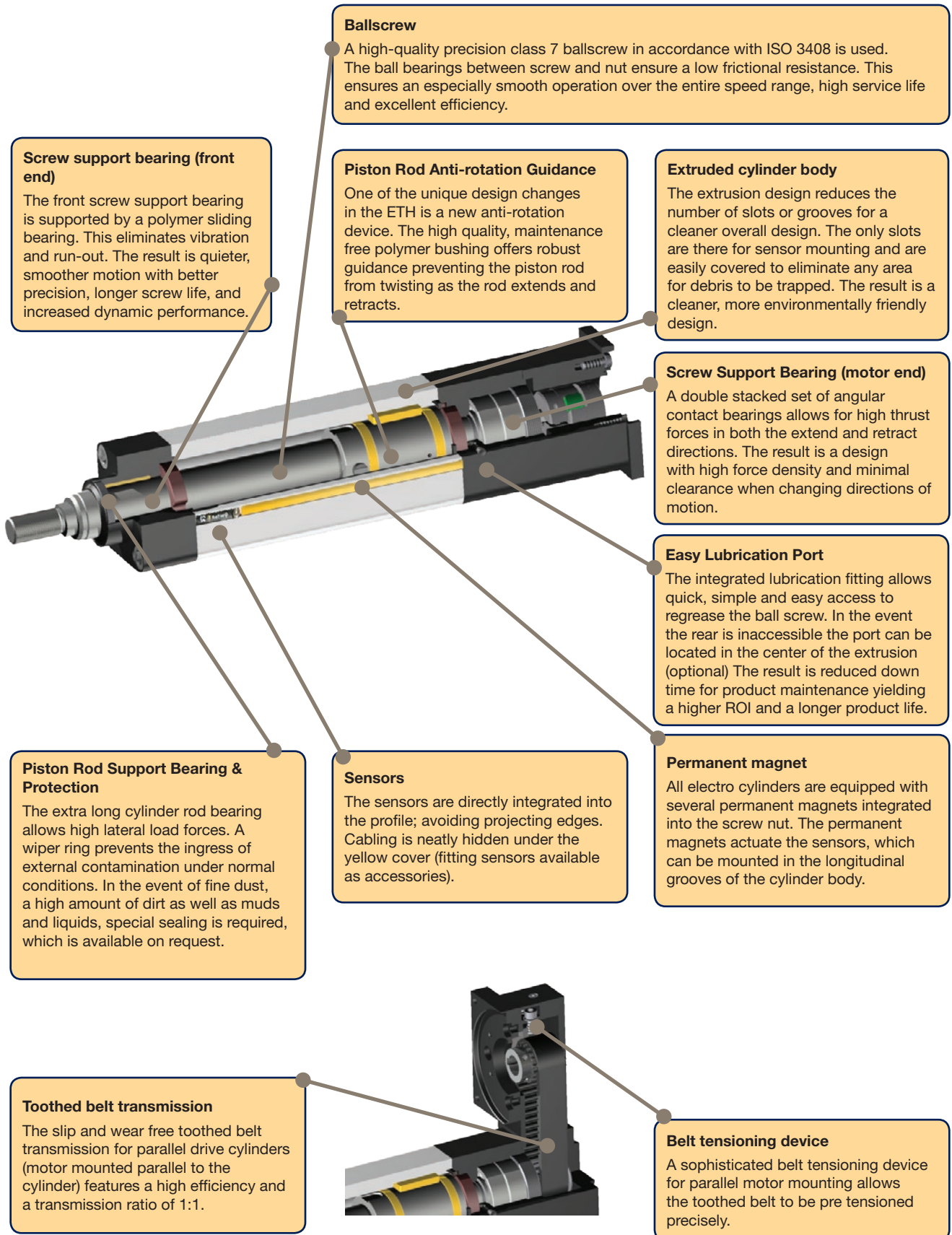

### Ballscrew

A high-quality precision class 7 ballscrew in accordance with ISO 3408 is used. The ball bearings between screw and nut ensure a low frictional resistance. This ensures an especially smooth operation over the entire speed range, high service life and excellent efficiency.

### Screw support bearing (front end)

The front screw support bearing is supported by a polymer sliding bearing. This eliminates vibration and run-out. The result is quieter, smoother motion with better precision, longer screw life, and increased dynamic performance.

### Piston Rod Anti-rotation Guidance

One of the unique design changes in the ETH is a new anti-rotation device. The high quality, maintenance free polymer bushing offers robust guidance preventing the piston rod from twisting as the rod extends and retracts.

### Extruded cylinder body

The extrusion design reduces the number of slots or grooves for a cleaner overall design. The only slots are there for sensor mounting and are easily covered to eliminate any area for debris to be trapped. The result is a cleaner, more environmentally friendly design.

### Screw Support Bearing (motor end)

A double stacked set of angular contact bearings allows for high thrust forces in both the extend and retract directions. The result is a design with high force density and minimal clearance when changing directions of motion.

### Easy Lubrication Port

The integrated lubrication fitting allows quick, simple and easy access to regrease the ball screw. In the event the rear is inaccessible the port can be located in the center of the extrusion (optional) The result is reduced down time for product maintenance yielding a higher ROI and a longer product life.

### Piston Rod Support Bearing & Protection

The extra long cylinder rod bearing allows high lateral load forces. A wiper ring prevents the ingress of external contamination under normal conditions. In the event of fine dust, a high amount of dirt as well as muds and liquids, special sealing is required, which is available on request.

### Sensors

The sensors are directly integrated into the profile; avoiding projecting edges. Cabling is neatly hidden under the yellow cover (fitting sensors available as accessories).

### Permanent magnet

All electro cylinders are equipped with several permanent magnets integrated into the screw nut. The permanent magnets actuate the sensors, which can be mounted in the longitudinal grooves of the cylinder body.

### Toothed belt transmission

The slip and wear free toothed belt transmission for parallel drive cylinders (motor mounted parallel to the cylinder) features a high efficiency and a transmission ratio of 1:1.

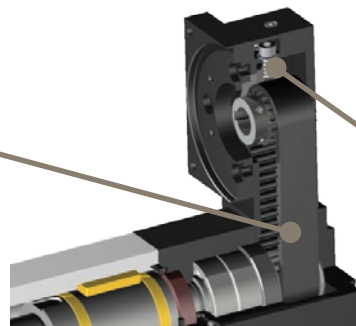

### Belt tensioning device

A sophisticated belt tensioning device for parallel motor mounting allows the toothed belt to be pre tensioned precisely.

## Technical Characteristics

Cylinder size type	Unit	ETH032			ETH050			ETH080				
		M05	M10	M16 <sup>4)</sup>	M05	M10	M20 <sup>4)</sup>	M05	M10	M32 <sup>4)</sup>		
Screw lead	[mm]	5	10	16	5	10	20	5	10	32		
Screw diameter	[mm]	16			20			32				
<b>Travels, speeds and accelerations</b>												
Available strokes <sup>1) 2)</sup>	[mm]	continuous from 50-1000 & standard strokes			continuous from 50-1200 & standard strokes			continuous from 50-1600 & standard strokes				
Max. permissible speed at stroke =												
50-400 mm	[mm/s]	333	667	1067	333	667	1333	267	533	1707		
600 mm	[mm/s]	286	540	855	333	666	1318	267	533	1707		
800 mm	[mm/s]	196	373	592	238	462	917	267	533	1707		
1000 mm	[mm/s]	146	277	440	177	345	684	264	501	1561		
1200 mm	[mm/s]	-	-	-	139	270	536	207	394	1233		
1400 mm	[mm/s]	-	-	-	-	-	-	168	320	1006		
1600 mm	[mm/s]	-	-	-	-	-	-	140	267	841		
Max. Acceleration	[m/s <sup>2</sup> ]	4	8	12	4	8	15	4	8	15		
<b>Forces</b>												
Max. axial traction/thrust force motor inline	[N]	3600	3700	2400	9300	7000	4400	17800	25100	10600		
Max. axial traction/thrust force <sup>3)</sup> Motor parallel	[N]		3280	2050		4920	2460		11620	3630		
Equivalent dynamic axial force at a lifetime of 2500 km	[N]	1130	1700	1610	2910	3250	2740	3140	7500	6050		
<b>Max. transmissible torque / force constant</b>												
Max. transmissible torque inline motor	[Nm]	3.2	6.5	6.8	8.2	12.4	15.6	15.7	44.4	60.0		
Max. transmissible torque <sup>3)</sup> Motor parallel	[Nm]	3.5	6.4		9.1	9.3		17.5	22.8			
Force constant motor inline <sup>5)</sup>	[N/Nm]	1131	565	353	1131	565	283	1131	565	177		
Force constant motor parallel <sup>5)</sup>	[N/Nm]	1018	509	318	1018	509	254	1018	509	159		
<b>Weight <sup>6)</sup></b>												
Weight of base unit with zero stroke (incl. Piston rod)	[kg]	1.2	1.2	1.4	2.2	2.2	2.4	7.1	7.5	8.5		
Weight of inline unit	[kg]	0.7			1.0			3.2				
Weight of parallel unit	[kg]	0.8			1.0			3.1				
Mass of additional stroke (incl. Cylinder rod)	[kg/m]	4.5			8.2			18.2				
Weight of cylinder rod with zero stroke	[kg]	0.06			0.15			0.59				
Weight of cylinder rod - additional length	[kg/m]	0.99			1.85			4.93				
<b>Mass moments of inertia</b>												
Motor parallel without stroke	[kgmm <sup>2</sup> ]	8.3	8.8	14.1	30.3	30.6	38.0	215.2	213.6	301.9		
Motor inline without stroke	[kgmm <sup>2</sup> ]	7.1	7.6	12.9	25.3	25.7	33.1	166.2	164.5	252.9		
Parallel/inline motor per meter	[kgmm <sup>2</sup> /m]	41.3	37.6	41.5	97.7	92.4	106.4	527.7	470.0	585.4		
<b>Accuracy: Bidirectional Repeatability (ISO230-2)</b>												
Motor inline	[mm]						±0.03					
Motor parallel	[mm]						±0.05					
<b>Efficiency</b>												
Motor inline	the efficiency includes all friction torques	[%]						90				
Motor parallel		[%]						81				
<b>Ambient conditions</b>												
Operating Temperature	[°C]						-10...+70					
Ambient temperature	[°C]						-10...+40					
Storage temperature	[°C]						-20...+40					
Humidity	[%]						0...95 % (non-condensing)					
Location height range	[m]						max. 3000					

<sup>1)</sup> "Order Code" (page 54), <sup>2)</sup> Intermediate stroke lengths may be interpolated.

<sup>3)</sup> Applies only for motor speed < 100 min<sup>-1</sup>. Transmissible torque depending on the motor speed n Motor parallel see page 15,

<sup>4)</sup> ATEX not available, <sup>5)</sup> The efficiency factors are included in the force constants.

<sup>6)</sup> Weight without rod-end and mounting option.

Cylinder size type	Unit	ETH100		ETH125	
		M10	M20	M10	M20
Screw lead	[mm]	10	20	10	20
Screw diameter	[mm]	50		63	

### Travels, speeds and accelerations

Available strokes <sup>1)2)</sup>	[mm]	continuous from 100-2000 & standard strokes		continuous from 100-2000 & standard strokes	
Max. permissible speed at stroke =					
100-400 mm	[mm/s]	400	800	417	833
500 mm	[mm/s]	400	747	417	807
600 mm	[mm/s]	333	622	395	684
800 mm	[mm/s]	241	457	290	514
1000 mm	[mm/s]	185	354	224	405
1200 mm	[mm/s]	148	284	180	329
1400 mm	[mm/s]	122	235	148	275
1600 mm	[mm/s]	102	198	125	234
2000 mm	[mm/s]	76	148	94	170
Max. Acceleration	[m/s <sup>2</sup> ]	8	10	8	10

### Forces

Max. axial traction/thrust force motor inline	[N]		56 000	88 700	114 000
Max. axial traction/thrust. <sup>3)</sup> Motor parallel	[N]	54 800	50 800	76 300	81 400
Equivalent dynamic axial force at a lifetime of 2500 km	[N]	18 410	27 100	27 140	49 600

### Max. transmissible torque / force constant

Max. transmissible torque inline motor	[Nm]	100	200	150	400
Max. transmissible torque. <sup>3)</sup> Motor parallel	[Nm]	108	200	150	320
Force constant motor inline <sup>5)</sup>	[N/Nm]	565	283	565	283
Force constant motor parallel <sup>5)</sup>	[N/Nm]	509	254	509	254

### Weight <sup>6)</sup>

Weight of base unit with zero stroke (incl. Piston rod)	[kg]	21	24	56	64
Weight of inline unit	[kg]	12		27	
Weight of parallel unit	[kg]	21		51	
Mass of additional stroke (incl. Cylinder rod)	[kg/m]	38		62	
Weight of cylinder rod with zero stroke	[kg]	1.2		2.9	
Weight of cylinder rod - additional length	[kg/m]	7.7		14.4	

### Mass moments of inertia

Motor parallel without stroke	[kgmm <sup>2</sup> ]	5860	6240	17 050	17 990
Motor inline without stroke	[kgmm <sup>2</sup> ]	2240	2620	12 960	13 400
Parallel/inline motor per meter	[kgmm <sup>2</sup> /m]	4270	4710	10 070	10 490

### Accuracy: Bidirectional Repeatability (ISO230-2)

Motor inline	[mm]	±0.03			
Motor parallel	[mm]	±0.05			

### Efficiency

Motor inline	the efficiency includes all friction torques	[%]	90		
Motor parallel		[%]	81		

### Ambient conditions

Operating Temperature	[°C]	-10...+70			
Ambient temperature	[°C]	-10...+40			
Storage temperature	[°C]	-20...+40			
Humidity	[%]	0...95 % (non-condensing)			
Location height range	[m]	max. 3000			

<sup>1)</sup> "Order Code" (page 54), <sup>2)</sup> Intermediate stroke lengths may be interpolated.

<sup>3)</sup> Applies only for motor speed < 100 min<sup>-1</sup>. Transmissible torque depending on the motor speed n Motor parallel see page 15,

<sup>5)</sup> The efficiency factors are included in the force constants, <sup>6)</sup> Weight without rod-end and mounting option..

**Technical Data apply under normal conditions and only for the individual operating and load modes. In the case of compound loads, it is necessary to verify in accordance with normal physical laws and technical standards whether individual ratings should be reduced. In case of doubt please contact Parker.**

# Dimensions

## Electro Cylinder

prepared for inline motor mounting

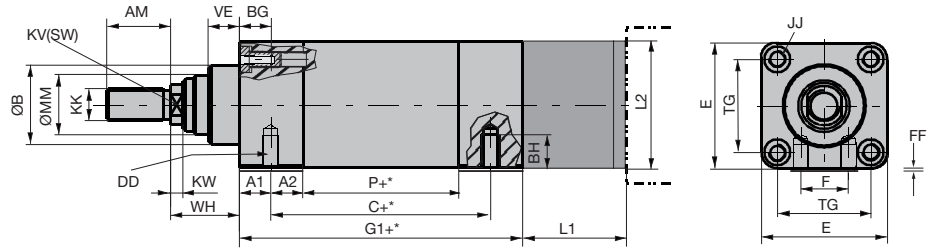

## Electro Cylinder

prepared for parallel motor mounting

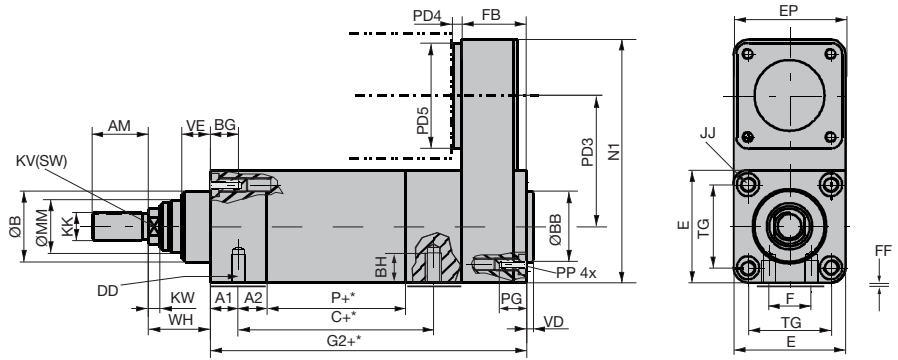

+\* = Measure + length of desired stroke

## Dimensions Standard & ATEX (IP-Version)

Cylinder size	Unit	ETH032			ETH050			ETH080			ETH100		ETH125	
		M05	M10	M16	M05	M10	M20	M05	M10	M32	M10	M20	M10	M20
Screw lead														
C	[mm]	93.6 (93.6)	102.6 (102.6)	106.6 (106.6)	99.5 (100.5)	105.5 (106.5)	117.5 (118.5)	141.5 (142.5)	159.5 (160.5)	189.5 (190.5)	- 2)		- 2)	
G1	[mm]	133 (180.5)	142 (189.5)	146 (193.5)	154 (198.5)	160 (204.5)	172 (216.5)	197 (259.5)	215 (277.5)	245 (307.5)	323 (349.5)	361 (387.5)	461 (487.5)	549 (575.5)
G2	[mm]	180.5 (228.5)	189.5 (237.5)	193.5 (241.5)	194 (239)	200 (245)	212 (257)	257 (320)	275 (338)	305 (368)	451 (478.0)	489 (516.0)	624 (651.0)	712 (739.0)
P	[mm]	66	75	79	67	73	85	89	107	137	162	200	192	280
A1	[mm]	14 (60)			15.5 (58.5)			21 (82)			- 2)		- 2)	
A2	[mm]	17			18.5			32			- 2)		- 2)	
AM	[mm]	22			32			40			70		96	
BG (=BN+BS)	[mm]	16			25			26			32		44	
BN Usable length of thread	[mm]	11			20			20			22		33	
BS Depth of width across flat (without thread)	[mm]	5			5			6			10		11	
BH	[mm]	9			12.7			18.5			- 2)		- 2)	
DD mount thread <sup>1)</sup>	[mm]	M6x1.0			M8x1.25			M12x1.75			- 2)		- 2)	
E	[mm]	46.5			63.5			95			120		150	
EP	[mm]	46.5			63.5			95			175		220	
F	[mm]	16			24			30			- 2)		- 2)	
FF	[mm]	0.5			0.5			1.0			0		0	
JJ	[mm]	M6x1.0			M8x1.25			M10x1.5			M16x2		M20x2.5	
PP	[mm]	M6x1.0			M8x1.25			M10x1.5			M16x2		M20x2.5	
PG (Thread depth on the PA housing)	[mm]	BG (=BN+BS)			BG (=BN+BS)			BG (=BN+BS)			26		35	
KK	[mm]	M10x1.25			M16x1.5			M20x1.5			M42x2		M48x2	
KV	[mm]	10			17			22			46		55	
ØMM h9	[mm]	22			28			45			70		85	
TG	[mm]	32.5			46.5			72			89		105	
KW	[mm]	5			6.5			10			10		10	
N1	[mm]	126			160			233.5			347		450	
FB	[mm]	47.5 (48)			40 (40.5)			60 (60.5)			128 (128.5)		163 (163.5)	
VD	[mm]	4			4			4			4		5	
ØBB	[mm]	30 d11			40 d11			45 d11			90 d9		110 d8	
VE	[mm]	12			16			20			20		20	
WH	[mm]	26			37			46			51		53	
ØB	[mm]	30 d11			40 d11			60 d11			90 d8		110 d8	

<sup>1)</sup> Thread "DD" is only mandatory for mounting method "F".

<sup>2)</sup> ETH100, ETH125 does not have a mounting thread on the underside.



## Accessories for ETH cylinder

### Outrigger bearing

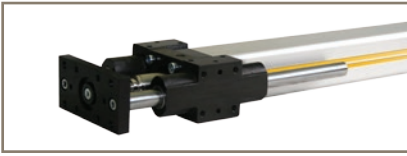

Function of outrigger bearing:

- Additional stability and precision
- Anti-rotation device for higher torques
- Absorption of lateral forces

### Initiators / Limit switches



### Mounting methods

#### Foot mounting



#### Mounting flanges



#### Centre trunnion mounting

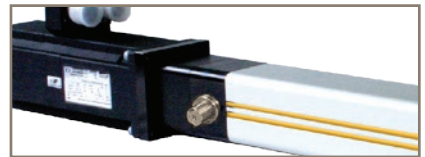

#### Front and rear plate

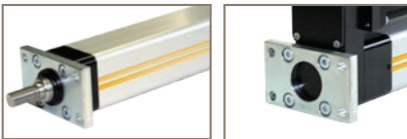

#### Rear clevis

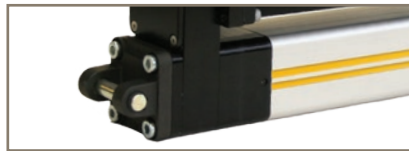

#### Rear eye mounting

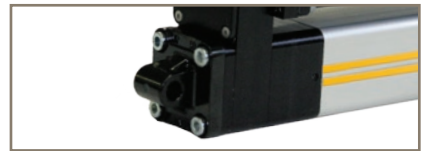

### Cylinder rod version

#### External thread



#### Internal thread



#### Rod clevis



#### Spherical rod eye



### Force sensor

#### Joint head with integrated force sensor

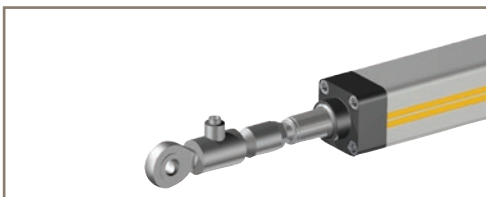

#### Rod clevis with force sensor

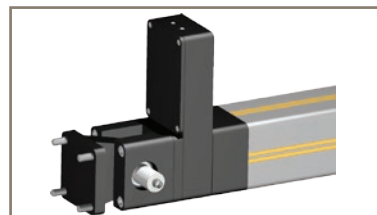

### Motor and amplifier

#### Servo amplifier

For additional information please see our website  
[www.parker.com/eme](http://www.parker.com/eme)

#### Motors and gears

For additional information on motors please see our website [www.parker-eme.com](http://www.parker-eme.com) and for gears [www.parker.com/eme/gear](http://www.parker.com/eme/gear)

# Electric Tubular Motor - ETT

## Overview

### Description

ETT is a direct thrust linear motor actuator, ideally suited to all kinds of linear handling and pick & place applications. It is a cost-effective and energy-efficient alternative to pneumatic cylinders in applications that demand greater flexibility and control.

The ETT's linear motion is directly generated without the need for mechanical transmission elements like ball screws, toothed belts and gearboxes. The tubular motor has two main components; the rod (shaft) and the stator with integrated feedback (body). The shaft is made of a stainless steel tube with built in neodymium magnets, which thanks to their high performance, are able to deliver impressive thrust values up to 2083 N. The main body comprises the stator winding, the feedback electronics and high performance bearings. A major benefit of the ETT design is that long and/or heavy duty cycles are possible without the need for additional cooling. The IP67 protection class allows the ETT tubular motor to be used in harsh environmental conditions.

### Features

- Ultra dynamic linear motion and position control capabilities
- Ideally suited for pneumatic substitution where greater position control capabilities are required
- Four lengths and four sizes meeting the requirements of the pneumatic ISO flange standard (DIN ISO 15552:2005-12) for simplified mechanical integration
- Swivelling electrical connectors and extensive accessory options allow flexible mounting
- Reduced mechanical complexity delivers high energy efficiency and reduces maintenance
- AISI304 stainless steel shaft allows it's use in "clean" environments
- High thermal efficiency improves reliability and increases mechanical life
- Wide choice of rod end mounting options, including swivel rod eye, increases flexibility

### Target markets

- Food, Pharmaceutical & Beverage
- Packaging Machines
- Material Handling
- Factory Automation



### Technical Characteristics - Overview

<b>Motor type</b>	Linear tubular servo motor
<b>Rod</b>	AISI304 (stainless steel)
<b>Rated force</b>	8...295 N
<b>Peak force</b>	56...2083 N
<b>Speed range</b>	up to 8 m/s
<b>Acceleration range</b>	up to 350 m/s <sup>2</sup>
<b>Mounting</b>	Screw fixed
<b>Shaft end</b>	Front male thread, Rear cap end Other options available
<b>Cooling</b>	Natural ventilation
<b>Protection level (IEC60034-5)</b>	IP67
<b>Feedback sensor</b>	Analog Hall 1Vpp (SinCos 90°) Other feedback on request
<b>Thermal protection</b>	KTY PTC or PT1000 as option
<b>Marking</b>	CE
<b>Voltage supply</b>	230 VAC (all sizes) 400 VAC (only ETT80)
<b>Temperature class</b>	Class F
<b>Connections</b>	Connectors Flying leads as option
<b>Bi-directional accuracy</b>	0.5 mm

## Technical Data

### ETT025

ETT025		ETT025S1	ETT025S2	ETT025S3
	Unit			
<b>Power supply 230 VAC</b>				
Effective stroke	[mm]	30...360		
Rated force	[N]	7.97	11.30	12.73
Peak force for 10 s <sup>1)</sup>	[N]	31.86	45.19	50.91
Peak force for 1 s <sup>1)</sup>	[N]	63.72	90.38	101.83
Maximum speed <sup>2)</sup>	[m/s]	4.61	5.49	5.83
Peak acceleration <sup>3)</sup>	[m/s <sup>2</sup> ]	212.40	301.25	339.42
Coil length	[mm]	146		
Rod length	[mm]	205...545		
Rod weight	[kg]	0.212...0.618		
Rod diameter	[mm]	12		
Pole pitch	[mm]	60		
Force constant	[N/A]	11.80	17.38	22.35
Back EMF	[V/(m/s)]	9.63	14.18	18.98
Back EMF (ph-ph,rms)	[V <sub>rms</sub> /(m/s)]	6.81	10.03	13.42
Phase resistance	[ohm]	17.17	25.06	33.40
Phase inductance	[mH]	5.42	7.89	10.44
Position repeatability	[mm]	±0.05		

<sup>1)</sup> Data valid at an ambient temperature of 40 °C

<sup>2)</sup> Based on triangular move over maximum stroke with nominal payload

<sup>3)</sup> Based on a 50 mm stroke, without payload

### ETT032

ETT032		ETT032S1	ETT032S2	ETT032S3
	Unit			
<b>Power supply 230 VAC</b>				
Effective stroke	[mm]	30...660	30...630	30...600
Rated force	[N]	13.18	17.90	22.54
Peak force for 10 s <sup>1)</sup>	[N]	52.72	71.60	90.14
Peak force for 1 s <sup>1)</sup>	[N]	105.45	143.20	180.28
Maximum speed <sup>2)</sup>	[m/s]	3.72	4.23	4.48
Peak acceleration <sup>3)</sup>	[m/s <sup>2</sup> ]	138.75	179.00	200.32
Coil length	[mm]	179	209	239
Rod length	[mm]	221...851		
Rod weight	[kg]	0.389...1.63		
Rod diameter	[mm]	16		
Pole pitch	[mm]	60		
Force constant	[N/A]	21.26	31.96	42.52
Back EMF	[V/(m/s)]	17.69	26.04	35.37
Back EMF (ph-ph,rms)	[V <sub>rms</sub> /(m/s)]	12.51	18.41	25.01
Phase resistance	[ohm]	31.46	43.84	59.71
Phase inductance	[mH]	14.57	21.75	29.20
Position repeatability	[mm]	±0.05		

<sup>1)</sup> Data valid at an ambient temperature of 40 °C

<sup>2)</sup> Based on triangular move over maximum stroke with nominal payload

<sup>3)</sup> Based on a 50 mm stroke, without payload

These ratings are valid for Parker Hannifin drives. Other drives might not achieve the same ratings

### ETT050

ETT050		ETT050S1	ETT050S2	ETT050S3
	Unit			
<b>Power supply 230 VAC</b>				
Effective stroke	[mm]	30...720	30...690	30...540
Rated force	[N]	33.17	45.94	118.55
Peak force for 10 s <sup>1)</sup>	[N]	132.66	183.77	474.18
Peak force for 1 s <sup>1)</sup>	[N]	265.32	367.54	948.36
Maximum speed <sup>2)</sup>	[m/s]	3.84	4.31	4.87
Peak acceleration <sup>3)</sup>	[m/s <sup>2</sup> ]	147.73	185.62	237.09
Coil length	[mm]	206	236	386
Rod length	[mm]	254...944		
Rod weight	[kg]	0.56...2.12		
Rod diameter	[mm]	25		
Pole pitch	[mm]	60		
Force constant	[N/A]	49.50	70.68	112.90
Back EMF	[V/(m/s)]	40.36	64.32	89.36
Back EMF (ph-ph,rms)	[V <sub>rms</sub> /(m/s)]	28.54	45.48	63.19
Phase resistance	[ohm]	42.45	62.97	41.75
Phase inductance	[mH]	23.80	35.20	22.42
Position repeatability	[mm]	±0.05		

<sup>1)</sup> Data valid at an ambient temperature of 40 °C

<sup>2)</sup> Based on triangular move over maximum stroke with nominal payload

<sup>3)</sup> Based on a 50 mm stroke, without payload

### ETT080

ETT080 Power supply 230-400 VAC	Unit	ETT080S2	ETT080S3*	ETT080S4	ETT080S5
Peak force <sup>1) 2) 4)</sup>	[N]	686	852	1506	2083
Peak current	[A]	12.5	11.7	20.5	29.0
<i>Without heatsink plate</i>					
Continous stall force duty cycle S1 <sup>1)</sup>	[N]	97	120	213	295
Continous stall current duty cycle S1 <sup>1)</sup>	[A]	1.8	1.7	2.9	4.1
Force @ duty cycle S3 5% <sup>1)</sup>	[N]	434	539	952	1318
Current @ duty cycle S3 5% <sup>1)</sup>	[A]	7.9	7.4	13.0	18.3
Force constant	[N/A]	54.80	72.57	73.44	71.88
Back EMF (ph-ph,rms)	[V <sub>rms</sub> /(m/s)]	31.64	59.26	42.4	41.5
Phase resistance	[ohm]	11.14	14.81	7.65	5.25
Phase inductance	[mH]	12.80	17.06	7.50	5.51
Power supply (drive side)	VAC	230/400			
Max DC bus voltage	VDC	325/566			
Pole pitch		60			
Maximum stroke <sup>5)</sup>	[mm]	736	706	586	460
Peak acceleration <sup>3)</sup>	[m/s <sup>2</sup> ]	238	264	330	352
Position repeatability	[mm]	0.05			
Accuracy	[mm]	0.5			

<sup>1)</sup> Data valid at an ambient temperature of 25 °C; <sup>2)</sup> Based on triangular move over maximum stroke with normal payload

<sup>3)</sup> Based on a 100 mm stroke, without payload; <sup>4)</sup> Considering a duty cycle of S3 2%; <sup>5)</sup> Other value under request

Manufacturing tolerance ±10%; \*Duty cycle S3 compliant to CEI EN60034-1 with max time 5 minutes.

These ratings are valid for Parker Hannifin drives. Other drives might not achieve the same ratings

## Standards and Conformance

### Low Voltage Directive

- 2006/95/EC

### EMC Directive

- 2004/108/EC

### Generic standard - Emission standard for industrial environments

- CEI EN 61000-6-4:2007

### Generic standard - Immunity for industrial environments

- CEI EN 61000-6-2:2006

Marked 

## Accessories for ETT Electric Tubular Motor

### Mounting methods

Foot mounting



Mounting flanges



Front and rear plate

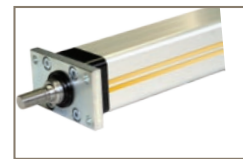

### Cylinder rod version

Plastic rod clevis



Plastic swivel rod eye



Alignment coupler



For additional information please see our catalogue 192-571001 or [www.parker.com/eme/ett](http://www.parker.com/eme/ett)



# OSP-E..SBR - Ball Screw Actuator with Internal Plain Bearing Guide



## Standard Versions:

- Standard piston rod with internal plain bearing guide
- Pitches of Ball Screw Spindle:  
Type OSP-E25SBR : 5 mm  
Type OSP-E32SBR: 5, 10 mm  
Type OSP-E50SBR: 5, 10, 25 mm

## Options:

- Keyway version

## Installation Instructions

Use the threaded holes in the free end cap and a profile mounting close to the motor end for mounting the actuator.

The piston rod is locked against rotations, but must not be used for radial loads  $M_x$ , that need to be guided externally. A compensation part e. g. piston rod eye is recommended.

Characteristics	Description
Series	OSP-E..SBR
Mounting	See drawings
Ambient temperature range	-20 °C to +80 °C
Installation	In any position
Encapsulation class	IP 54
<b>Material</b>	
Slotted Profile	Extruded anodized aluminium
Ball screw	Steel
Ball nut	Steel
Piston rod	Stainless steel
Guide bearings	Low friction plastic
Sealing band	Hardened corrosion resistant steel
Screws, nuts	Zinc plated steel
Mountings	Zinc plated steel and aluminium

## Weight (mass) and Inertia

Series	Total weight (Mass) [kg]		Moving mass [kg]		Inertia [ $\times 10^{-6}$ kgm <sup>2</sup> ]	
	At stroke 0 m	Actuator head	At stroke 0 m	Add per metre stroke	At Stroke 0 m	Add per metre stroke
OSP-E25SBR	0.7	3.0	0.2	0.9	1.2	11.3
OSP-E32SBR	1.7	5.6	0.6	1.8	5.9	32.0
OSP-E50SBR	4.5	10.8	1.1	2.6	50.0	225.0

## Maintenance

All moving parts are long-term lubricated for a normal operational environment. Parker Origa recommends a check and lubrication of the actuator, and if necessary a change of wear parts, after an operation time of 12 months or 3000 km travel of distance. Please refer to the operating instructions supplied with the actuator.

## First service start-up

The maximum values specified in the technical data sheet for the different products must not be exceeded. Before taking the actuator as a machine into service, the user must ensure the adherence to the EC Machine Directive 2006/42/EG.

## Sizing Performance Overview

### Maximum Loadings

#### Sizing of Actuator

The following steps are recommended for selection :

1. Check that the maximum values in the adjacent chart and transverse force/ stroke graph below are not exceeded.
2. Check the lifetime/travel distance in graph below.
3. When sizing and specifying the motor, the RMS-average torque must be calculated using the cycle time in application

#### Performance Overview

Characteristics	Unit	Description					
Series		OSP-E25SBR	OSP-E32SBR		OSP-E50SBR		
Pitch	[mm]	5	5	10	5	10	25
Max. speed	[m/s]	0.25	0.25	0.5	0.25	0.5	1.25
Linear motion per revolution drive shaft	[mm]	5	5	10	5	10	25
Max. rpm drive shaft	[min <sup>-1</sup> ]		3000	3000	3000		
Max. effective action force $F_A$	[N]	260	900		1200		
Corresponding torque drive shaft	[Nm]	0.45	1.1	1.8	1.3	2.8	6.0
No-load torque	[Nm]	0.2	0.2	0.3	0.3	0.4	0.5
Max. allowable torque on drive shaft	[Nm]	0.6	1.5	2.8	4.2	7.5	20
Max. allowable acceleration	[m/s <sup>2</sup> ]	5	5		5		
Typical repeatability	[mm/m]	±0.05		±0.05	±0.05		
Max. Standard stroke length	[mm]	500	500	500			

## Transverse Force / Stroke

The permissible transverse force is reduced with increasing stroke length. according to the adjacent graphs.

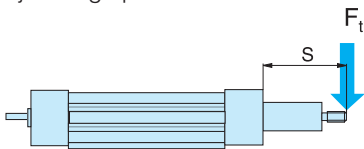

#### Transverse Force / Stroke

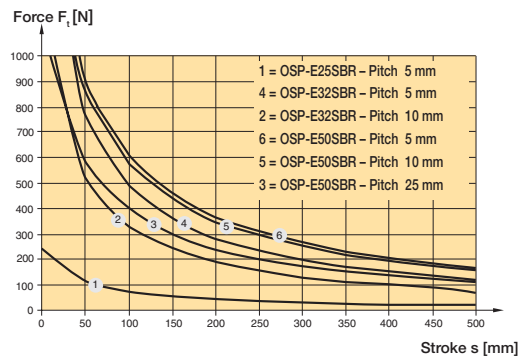

## Maximum rpm / Stroke

At longer strokes the speed has to be reduced according to the adjacent graphs.

#### Maximum rpm / Stroke

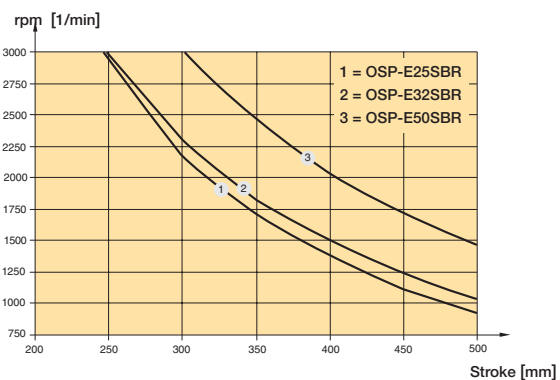

# Options and Accessories

## OSP-E..SBR Ball screw actuator with internal plain bearing guide

### STANDARD VERSIONS OSP-E..SBR

Standard piston rod with internal guidance and integrated magnet set for contactless position sensing. Dovetail profile for mounting of accessories and the actuator itself.



**END CAP MOUNTING**  
 For end-mounting the actuator on the extending rod side.

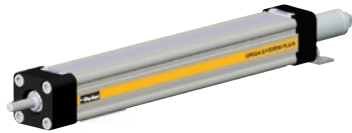

**COMPENSATION**  
 Piston Rod eye



**Flange Mounting C**  
 For end-mounting the actuator on the extending rod side.



**Piston rod Clevis**



### BALL SCREW PITCH

The ball screws spindles are available in various pitches:  
 OSP-E25SBR: 5 mm  
 OSP-E32SBR: 5, 10 mm  
 OSP-E50SBR: 5, 10, 25 mm

**Piston Rod compensating coupling**  
 For compensating of radial and angular misalignments



### ACCESSORIES

**PROFILE MOUNTING**  
 For mounting the actuator on the dovetail grooves and on the motor end.

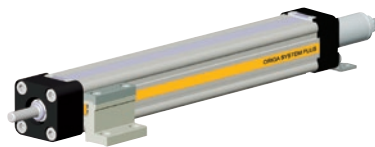

**MAGNETIC SWITCHES  
 SERIES RST AND EST**  
 For contactless position sensing of end stop and intermediate carrier positions.



### MOTOR MOUNTINGS

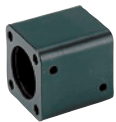

**Trunning mounting EN in combination with pivot mounting EL.**  
 – steplessly adjustable in axial direction.

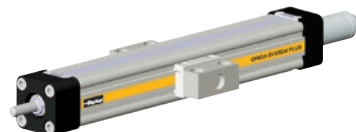

# OSP-E..STR - Trapezoidal Screw Actuator with Internal Plain Bearing Guide



## Standard Versions:

- Dovetail profile for mounting of accessories and the actuator itself
- Pitch of Trapezoidal Spindle:  
Type OSP-E25STR: 3 mm  
Type OSP-E32STR: 4 mm  
Type OSP-E50STR: 5 mm

## Contactless position sensing

Please use the magnetic switch mentioned below:

**P8S-GRFAX** (Type: reed, 2-wire, normally open, 3m flying lead PUR-cable)

**P8S-GPCHX** (Type: PNP, 3-wire, normally open, M8R connector 0,3m knurled screw)

## Installation Instructions

Use the threaded holes in the free end cap and a profile mounting close to the motor end for mounting the actuator.

The piston rod is not locked against rotation and needs to be guided externally. A compensation part e. g. piston rod eye is recommended.

Characteristics	Description
Series	OSP-E..STR
Mounting	See drawings
Ambient temperature range	-20 °C to +70 °C
Installation	In any position
Encapsulation class	IP 54
<b>Material</b>	
Slotted Profile	Extruded anodized aluminium
Trapezoidal screw	Cold rolled steel
Drive nut	Thermoplastic polyester
Piston rod	Stainless steel
Guide bearings	Low friction plastic
Sealing band	Hardened corrosion resistant steel
Screws, nuts	Zinc plated steel
Mountings	Zinc plated steel and aluminium

## Weight (mass) and Inertia

Series	Total weight (Mass) [kg]		Moving mass [kg]		Inertia [ $\times 10^{-6}$ kgm <sup>2</sup> ]	
	At stroke 0 m	Actuator head	At stroke 0 m	Add per metre stroke	At Stroke 0 m	Add per metre stroke
OSP-E25STR	0.4	2.9	0.1	0.7	1.1	10.3
OSP-E32STR	0.9	5.4	0.2	1.2	3.9	29.6
OSP-E50STR	2.4	10.6	0.8	1.6	24.6	150

## Maintenance

All moving parts are long-term lubricated for a normal operational environment. Parker Origa recommends a check and lubrication of the actuator, and if necessary a change of wear parts, after an operation time of 12 months or 3000 km travel of distance. Please refer to the operating instructions supplied with the actuator.

## First service start-up

The maximum values specified in the technical data sheet for the different products must not be exceeded. Before taking the actuator as a machine into service, the user must ensure the adherence to the EC Machine Directive 2006/42/EG.

## Sizing Performance Overview

### Maximum Loadings

#### Sizing of Actuator

The following steps are recommended for selection :

1. Check that the maximum values in the adjacent chart and transverse force/ stroke graph below are not exceeded.
2. Check the lifetime/travel distance in graph below.
3. When sizing and specifying the motor, the RMS-average torque must be calculated using the cycle time in application

#### Performance Overview

Characteristics	Unit	Description		
Size		OSP-E25STR	OSP-E32STR	OSP-E50STR
Pitch	[mm]	3	4	5
Max. speed	[m/s]	0.075	0.1	0.125
Linear motion per revolution, drive shaft	[mm]	3	4	5
Max. rpm, drive shaft	[min <sup>-1</sup> ]	1500 <sup>2)</sup>	1500	1500
Max. effective action force $F_A$ Corresponding torque on drive shaft	[N] [Nm]	800 1.35	1600 3.4	3300 9.25
No-load torque	[Nm]	0.3	0.4	0.5
Max. allowable torque on drive shaft	[Nm]	1.7	4.4	12
Self-locking force $F_L$ <sup>1)</sup>	[N]	800	1600	3300
Typical repeatability	[mm/m]	±0,5	±0,5	±0,5
Max.Standard stroke length	[mm]	500	500	500

<sup>1)</sup> Related to screw types Tr 12x3, Tr 16x4, Tr 24x5

<sup>2)</sup> from 0,4 m stroke max. 1200 min-1 permissible

## Transverse Force / Stroke

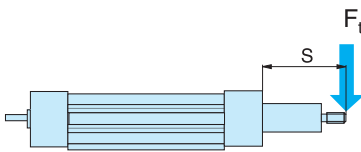

#### Transverse Force / Stroke

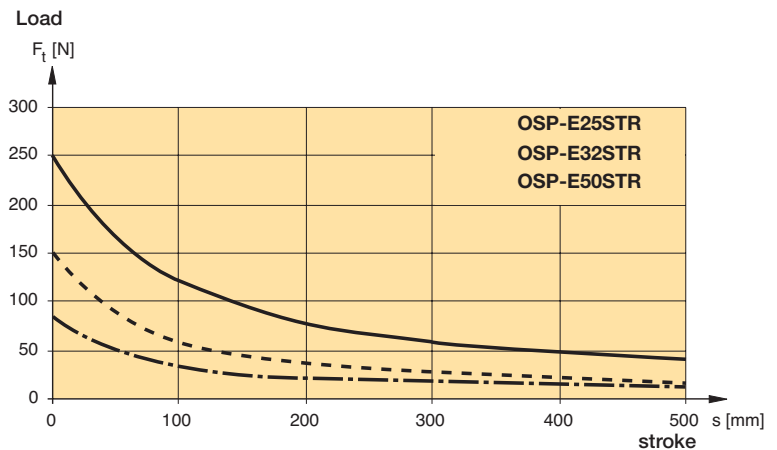

The graph is based upon 10% intermittent usage

## Performance / Action Force

The Actuators are designed for a 10% intermittent usage.  
 The performance to be expected depends on the maximum required actions force of the application.  
 An increase of the action force will lead to a reduced performance.

#### Performance as a function of the action force

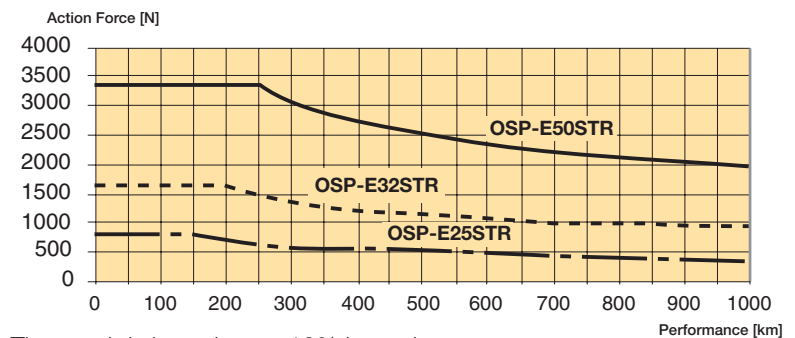

The graph is based upon 10% intermittent usage

# Options and Accessories

## OSP-E..STR Trapezoidal screw actuator with internal plain bearing guide

### STANDARD VERSIONS

#### OSP-E..STR

Standard piston rod with internal guidance and integrated magnet set for contactless position sensing. Dovetail profile for mounting of accessories and the actuator itself.



#### END CAP MOUNTING

For end-mounting the actuator on the extending rod side.

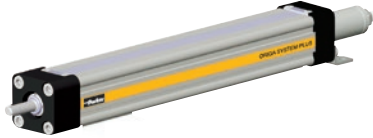

#### COMPENSATION PISTON ROD EYE



#### FLANGE MOUNTING C

For end-mounting the actuator on the extending rod side.



#### PISTON ROD CLEVIS



### ACCESSORIES

#### MOTOR MOUNTINGS

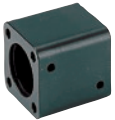

#### PROFILE MOUNTING

For mounting the actuator on the dovetail grooves and on the motor end.

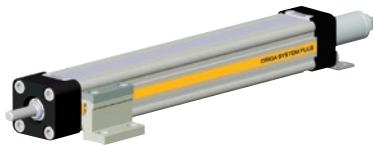

#### PISTON ROD COMPENSATING COUPLING

For compensating of radial and angular misalignments



#### TRUNNING MOUNTING EN in combination with pivot mounting EL.

– steplessly adjustable in axial direction.

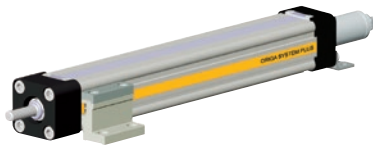

#### MAGNETIC SWITCHES SERIES RST AND EST

For contactless position sensing of end stop and intermediate carrier positions.







# Rodless Linear Handling Actuators



HPLA

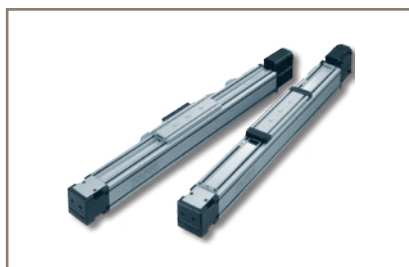

HLE



OSP-E..BHD



OSP-E..B



OSP-E..SB



OSP-E..ST

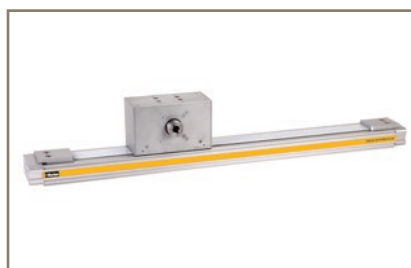

OSP-E..BV



LCB



LCR

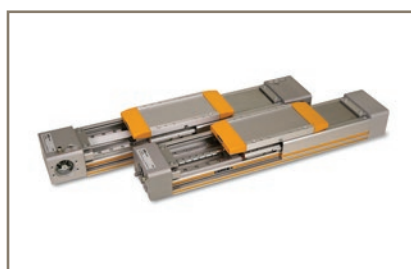

HMR

## HPLA - Linear Actuator with Plastic-Sheathed Rollers

For guiding, moving and positioning, even over long travels, we offer the HPLA linear actuator:

- Travels up to 20 meters
- High speeds up to 5 m/s
- High payloads up to 1600 kg
- Nominal drive torque up to 244 Nm
- Nominal thrust force up to 5500 N
- Repeatability up to  $\pm 0.05$  mm
- High mechanic efficiency



### Specifications

Frame sizes		HPLA 080		HPLA 120		HPLA 180	
Roller guiding system		Plastic	Steel	Plastic	Steel	Plastic	Steel
<b>Weight of base unit without stroke</b>							
HPLA with standard carriage	[kg]	6.0	6.6	18.6	19.8	49.8	53.4
HPLA with steel strip cover	[kg]	6.8	7.5	20.2	21.6	57.2	61.6
HPLA with extended carriage	[kg]	7.8	8.6	23.5	25.2	67.4	72.6
HPLA with steel strip cover	[kg]	8.6	9.5	25.2	27.1	74.8	80.9
Weight of standard carriage & load attachment plate	[kg]	1.5	1.6	5.5	5.7	11.4	11.8
HPLA with steel strip cover	[kg]	1.7	1.8	5.8	6.0	12.3	12.6
Weight of extended carriage & load attachment plate	[kg]	2.4	2.6	8.5	8.9	20.3	21.0
HPLA with steel strip cover	[kg]	2.6	2.8	8.8	9.2	21.1	21.8
Additional weight per meter of stroke	[kg/m]	6.0	7.2	13.5	15.4	29.2	33.4
Weight with steel strip cover	[kg/m]	6.1	7.3	13.7	15.5	29.4	33.6
<b>Travel lengths and speeds</b>							
Max. travel speed	[m/s]	5.0					
Max. acceleration	[m/s <sup>2</sup> ]	10.0					
Max. travel path (standard carriage)	[mm]	5610	5590	9560	9530	9440	9400
ditto with steel strip cover	[mm]	5540	5520	9470	9440	9240	9200
Max. travel path (extended carriage)	[mm]	5460	5440	9360	9330	9140	9100
ditto with steel strip cover	[mm]	5390	5370	9270	9240	8940	8900
<b>Overall dimensions and physical data of guiding profile</b>							
Section	[mm]	80 x 80		120 x 120		180 x 180	
<b>Forces and torques</b>							
max. drive torque	[Nm]	32		96		365	
max. Thrust force	[N]	1114		2234		5457	
Repeatability up to 3 m <sup>(1)</sup>	[mm]	$\pm 0.05$		$\pm 0.05$		$\pm 0.05$	
Repeatability from 3 m <sup>(1)</sup>	[mm]	$\pm 0.1$		$\pm 0.1$		$\pm 0.1$	
<b>Toothed pulley and toothed belt data</b>							
Travel distance per revolution	[mm/U]	180		270		420	
Number of teeth of pulley		18		27		21	
Toothed belt width / pitch	[mm]	25/10		32/10		56/20	

<sup>(1)</sup> at a constant ambient and operating temperature

## Dimensions

### HPLA without steel strip cover

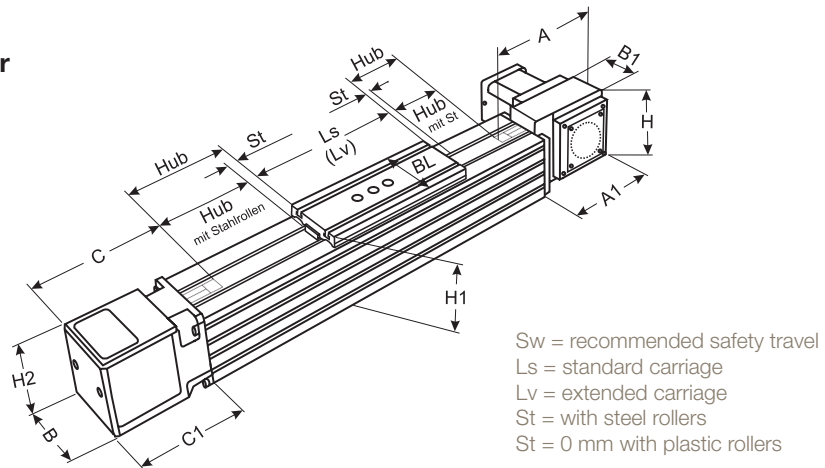

**HPLA with toothed belt without steel strip cover**

	B	B1	BL	H	H1	H2	A1	A	C	C1	Ls	Lv	St
<b>HPLA 80</b>	80	46	76	100	100	80	144	164	128	108	250	400	10
<b>HPLA 120</b>	120	60	110	135	143	120	185	205	160	140	300	500	13
<b>HPLA 180</b>	180	95	170	213	215	180	265	293	263	235	400	700	20

### HPLA with steel strip cover

The optional steel strip cover is perfectly integrated into the linear actuator design and protects timing belt, rollers and the running surfaces of the profile reliably from contamination (protection class IP30).

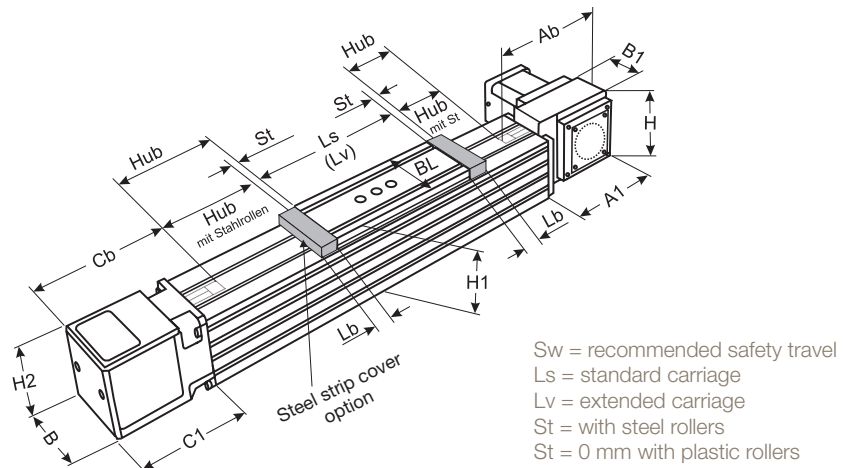

**HPLA with toothed belt and steel strip cover**

	B	B1	BL	H	H1	H2	A1	Ab	Cb	C1	Ls	Lv	Lb	St
<b>HPLA 80</b>	80	46	76	100	100	80	144	199	163	108	250	400	40	10
<b>HPLA 120</b>	120	60	110	143	143	120	185	250	205	140	300	500	50	13
<b>HPLA 180</b>	180	95	170	215	215	180	265	393	363	235	400	700	100	20

### Advantages of plastic roller guiding:

- clean operation, as the travel surface is free of lubricants
- low maintenance

### Advantages of steel roller guiding on an integrated steel strip:

- high load bearing capacity
- high stiffness

## HLE - Linear Actuator with Plastic-Sheathed Rollers

For guiding, moving and positioning, even over long travels, we offer the HLE linear actuator:

- Long strokes up to 20 m
- High speeds up to 5 m/s
- Transmissible drive torque max. 108 Nm
- High load capacity
- Repeatability up to  $\pm 0.05$  mm
- High mechanical efficiency of 95 %
- Low abrasion (suitable for clean room up to class 10)
- Low wear, low maintenance and low-noise operation
- High dynamics due to low-mass, backlash-free carriage



The linear actuators are available in two sizes (**HLE 100** and **HLE 150**). They are suitable for fast linear movements over long travel strokes. The actuators are available in many different configurations with various options and accessories.

### Specifications

Frame sizes		HLE 100		HLE 150	
		Standard	Steel strip cover	Standard	Steel strip cover
<b>Weight of base unit without stroke</b>					
HLE with standard carriage	[kg]	11.5	12.7	28.6	31.2
HLE with extended carriage	[kg]	14.6	15.8	35.9	38.5
Weight of standard carriage & load attachment plate	[kg]	2.5	2.8	6.7	7.3
Weight of extended carriage & load attachment plate	[kg]	4.1	4.4	10.9	11.5
Additional weight per meter of stroke	[kg/m]	9.9	10.0	21.0	21.1
<b>Travel lengths and speeds</b>					
Maximum travel speed	[m/s]	5.0		5.0	
Maximum Acceleration	[m/s <sup>2</sup> ]	10.0		10.0	
Maximum travel path, standard carriage with one profile	[mm]	6300	6210	9150	9060
Maximum travel path, extended carriage with one profile	[mm]	6150	6060	9000	8910
<b>Overall dimensions and physical data of guiding profile</b>					
Section	[mm]	100 x 100		150 x 150	
<b>Forces and torques</b>					
Nominal drive torque	[Nm]	15.7		51.6	
Nominal belt traction force (payload)	[N]	580		1350	
Repeatability up to 3 m <sup>(1)</sup>	[mm]	$\pm 0.05$		$\pm 0.05$	
Repeatability from 3 m <sup>(1)</sup>	[mm]	$\pm 0.1$		$\pm 0.1$	
<b>Toothed pulley and toothed belt data</b>					
Travel distance per revolution	[mm/U]	170		240	
Diameter of pulley	[mm]	54.113		76.394	
Toothed belt width / pitch	[mm]	25/10		32/10	
Weight of toothed belt	[kg/m]	0.166		0.213	

<sup>(1)</sup> at a constant ambient and operating temperature

## Dimensions

### HLE without steel strip cover

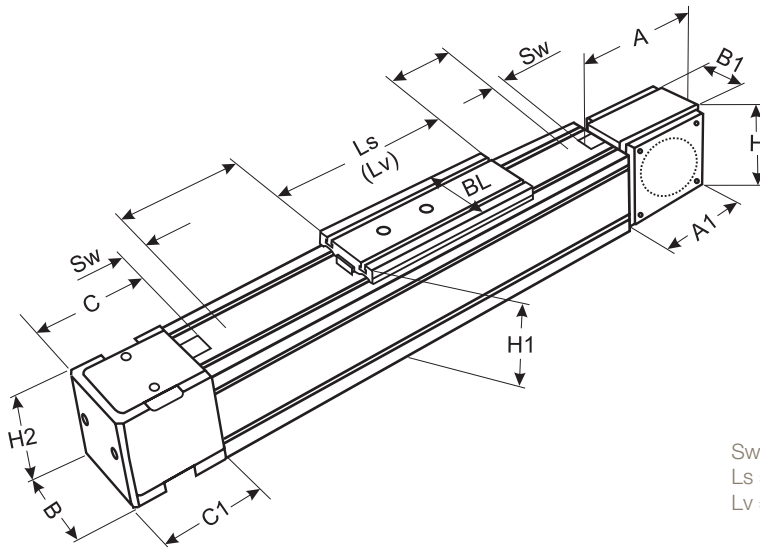

Sw = recommended safety travel  
Ls = standard carriage  
Lv = extended carriage

### HLE with toothed belt without steel strip cover

	B	B1	BL	H	H1	H2	A1	A	C	C1	Ls	Lv	Sw
<b>HLE 100</b>	100	52	90	132	120	100	150	174	126	102	300	450	125
<b>HLE 150</b>	150	60	140	187	175	150	198	234	146	110	350	500	125

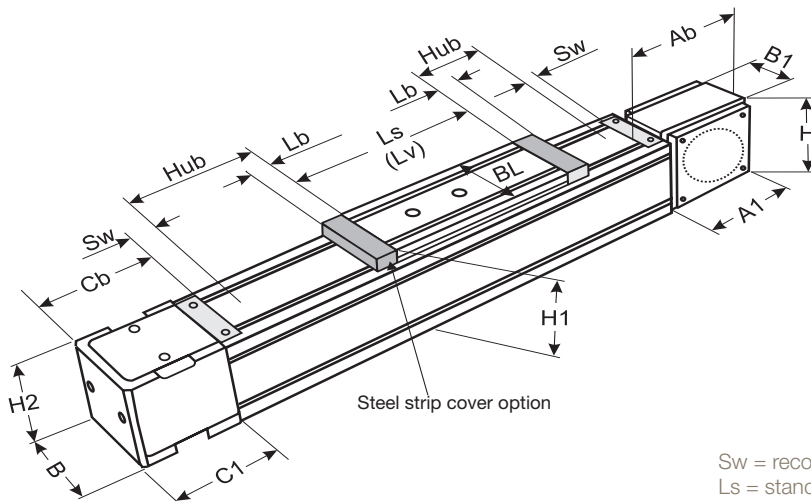

Sw = recommended safety travel  
Ls = standard carriage  
Lv = extended carriage

### HLE with toothed belt and steel strip cover

	B	B1	BL	H	H1	H2	A1	Ab	Cb	C1	Ls	Lv	Lb	Sw
<b>HLE 100</b>	100	52	90	132	120	100	150	219	171	102	300	450	35	125
<b>HLE 150</b>	150	60	140	187	175	150	198	279	191	110	350	500	35	125



## Accessories for Toothed Belt Actuators

### Assembly angle plate isosceles

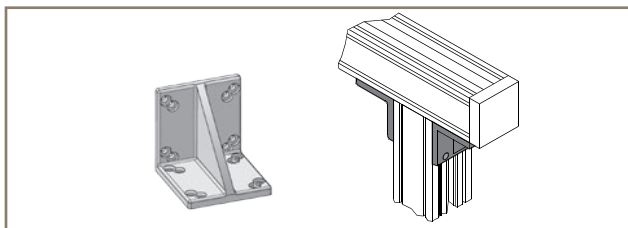

### Assembly angle plate scalene

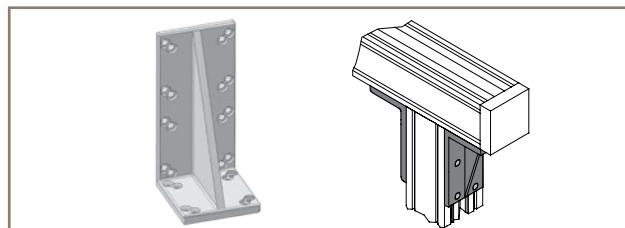

The assembly angle plates are used to connect linear actuators to the basic structure (as support, you may use a Parker profile), or with your construction elements.

### Toe Clamp

The toe clamps are used in conjunction with the standard load attachment plate to rapidly install and attach various combinations of linear actuators.

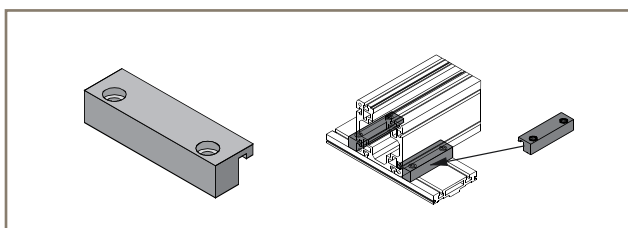

### External stop buffer

The external stop buffer is mounted in the grooves of the profile and can be adjusted infinitely.

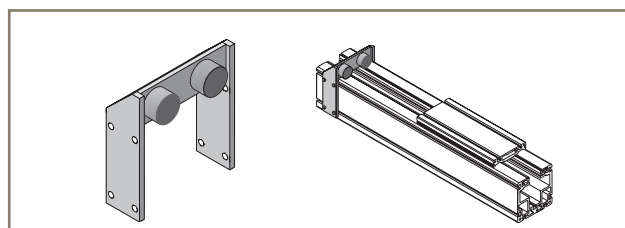

### T-Nuts and bolts

The T nuts and bolts can be used to attach other components in the T-slots of the profile, or on the upper side of the load attachment plate.

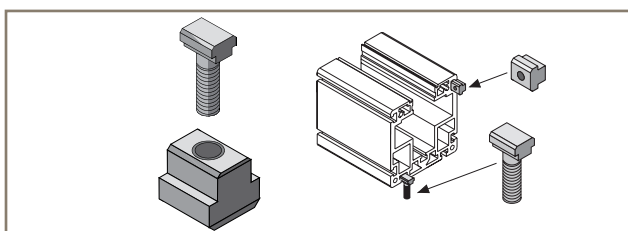

### Intermediate shaft bearing for double actuators

The intermediate shaft bearing is used to support the connection shaft of a double actuator in the event of a long axis distance. The intermediate shaft bearing must be used if the critical rotational speed is exceeded with the double actuator connection shaft.

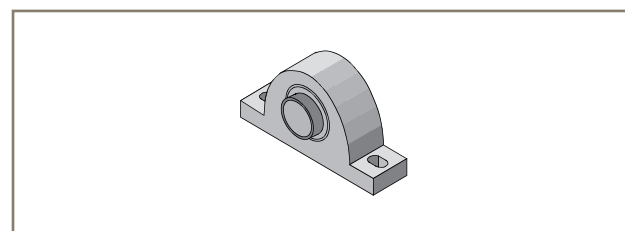

### Longitudinal flanges

The working stroke can be more than doubled when using the flange plates. A longitudinal flange is required if the travel path exceeds the profile length.

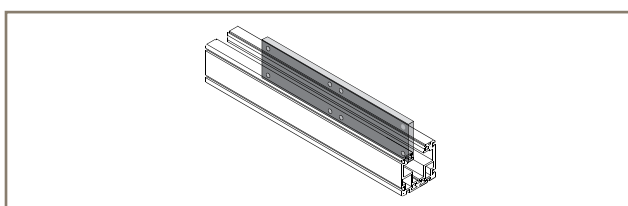

### Tripping plate

The tripping plate is suitable for all standard load flange plates.

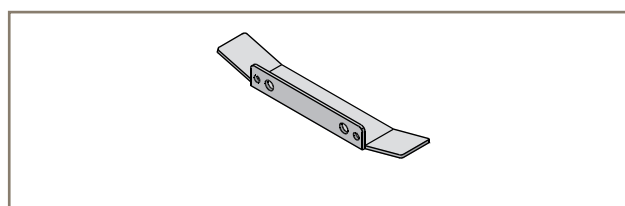

### Mechanical limit switch

Switching button as per DIN EN50047. The contacts satisfy the safety requirements by forced opening.

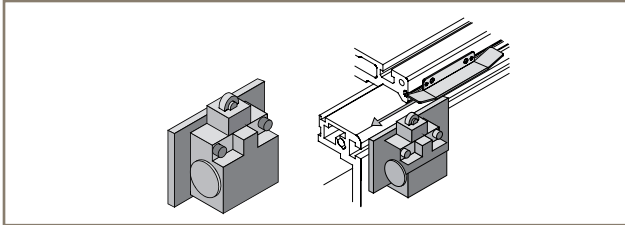

### Electrical limit switches

The sensor is activated by a tripping plate on the side on the flange plate.

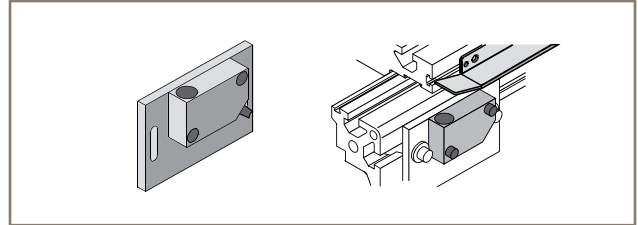

### Linear Encoder

The use of a linear encoder increases the static position stiffness of the linear actuator as well as the control properties and positioning accuracy. An additional cable carrier is required due to the moving sensor.

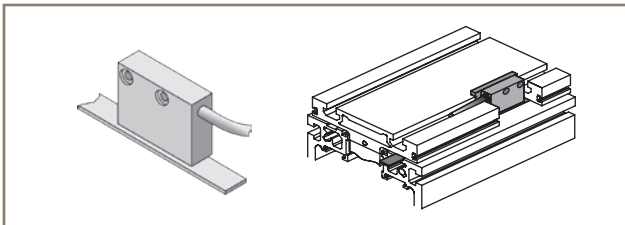

### Cable carrier

A cable carrier is needed when making power connections to moving elements. Use only electrical cables which are suitable for use in cable carriers.

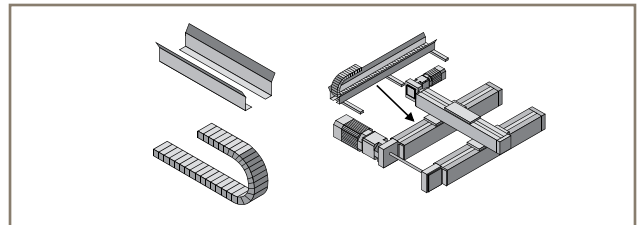

### Motor and amplifier

#### Servo amplifier

For additional information please see our product catalog 192-490123 or our website [www.parker.com/eme](http://www.parker.com/eme)

#### Motors and gears

For additional information on motors please see our website [www.parker-eme.com/sm](http://www.parker-eme.com/sm) and for gears [www.parker.com/eme/gear](http://www.parker.com/eme/gear)

### Other accessories / software

#### DimAxes

Dimensioning tool for Parker linear actuators, for PC from Windows version 95  
Download free of charge from:  
<http://www.parker-eme.com/dimaxes>

#### Belt tension measuring device RSM

For accurately setting the toothed belt tension.



# OSP-E..BHD - Belt Actuator with Integrated Ball Bearing and Roller Guide

## Standard Versions:

- Belt Actuator with integrated Ball Bearing Guide
- Drive shaft with clamp shaft or plain shaft
- Choice of motor mounting side
- Dovetail profile for mounting of accessories and the actuator itself



## Options:

- Tandem version for higher moments
- Bi-parting version for synchronised movements
- Integrated planetary gearbox
- Drive shaft with
  - clamp shaft and plain shaft
  - hollow shaft with keyway
- Special drive shaft versions on request

## Installation Instructions

Use the threaded holes in the end cap for mounting the actuator.

Check if profile mountings are needed using the maximum allowable unsupported length graph.

At least one end cap must be secured to prevent axial sliding when profile mountings are used.

Characteristics	Description
Series	OSP-E..BHD
Mounting	See drawings
Ambient temperature range	-30 °C to +80 °C
Installation	In any position
Encapsulation class	IP 54
<b>Material</b>	
Slotted profile	Extruded anodized aluminium
Belt	Steel-corded polyurethane
Pulley	Aluminium
Guide	Ball bearing guide
Guide rail	Hardened steel rail with high precision, accuracy class N
Guide carrier	Steel carrier with integrated wiper system, grease nipples, preloaded 0.02 x C, accuracy class H
Steel band	Hardened, corrosion resistant steel
Screws, nuts	Zinc plated steel
Mountings	Zinc plated steel and aluminium

## Weight (mass) and Inertia

Series	Weight (mass)[kg]			Inertia [ $\times 10^{-6}$ kgm <sup>2</sup> ]		
	At stroke 0 m	Add per metre stroke	Moving mass	At stroke 0 m	Add per metre stroke	per kg mass
OSP-E20BHD	2.8	4	0.8	280	41	413
OSP-E25BHD	4.3	4.5	1.5	1229	227	821
OSP-E32BHD	8.8	7.8	2.6	3945	496	1459
OSP-E50BHD	26	17	7.8	25678	1738	3103
OSP-E20BHD*	4.3	4	1.5	540	41	413
OSP-E25BHD*	6.7	4.5	2.8	2353	227	821
OSP-E32BHD*	13.5	7.8	5.2	7733	496	1459
OSP-E50BHD*	40	17	15	49180	1738	3103

\* Version: Tandem and Bi-parting (Option)

## Maintenance

Depending on operating conditions, inspection of the actuator is recommended after 12 months or 3000 km operation. Please refer to the operating instructions supplied with the actuator.

## First service start-up

The maximum values specified in the technical data sheet for the different products must not be exceeded. Before taking the actuator as a machine into service, the user must ensure the adherence to the EC Machine Directive 2006/42/EG.

## Sizing Performance Overview

### Maximum Loadings

#### Sizing of Actuator

The following steps are recommended for selection :

1. Determination of the lever arm length  $l_x$ ,  $l_y$  and  $l_z$  from  $m_e$  to the centre axis of the actuator.
2. Calculation of the load  $F_x$  or  $F_y$  to the carrier caused by  $m_e$   
 $F = m_e \cdot g$
3. Calculation of the static and dynamic force  $F_A$  which must be transmitted by the belt.  
$$F_{A(\text{horizontal})} = F_a + F_0$$
$$= m_g \cdot a + M_0 \cdot 2\pi / U_{ZR}$$
  
$$F_{A(\text{vertical})} = F_g + F_a + F_0$$
$$= m_g \cdot g + m_g \cdot a + M_0 \cdot 2\pi / U_{ZR}$$
4. Calculation of all static and dynamic bending moments  $M_x$ ,  $M_y$  and  $M_z$  which occur in the application  
 $M = F \cdot l$
5. Selection of maximum permissible loads via Table T3.
6. Calculation and checking of the combined load, which must not be higher than 1.
7. Checking of the maximum torque that occurs at the drive shaft in Table T2.
8. Checking of the required action force  $F_A$  with the permissible load value from Table T1.

For motor sizing, the effective torque must be determined, taking into account the cycle time.

#### Legend

- $l$  = distance of a mass in the x-, y- and z-direction from the guide [m]
- $m_e$  = external moved mass [kg]
- $m_{LA}$  = moved mass of actuator [kg]
- $m_g$  = total moved mass ( $m_e + m_{LA}$ ) [kg]
- $F_{x/y}$  = load exerted on the carrier in dependence of the installation position [N]
- $F_A$  = action force [N]
- $M_0$  = no-load torque [Nm]
- $U_{ZR}$  = circumference of the pulley (linear movement per revolution) [m]
- $g$  = gravity [m/s<sup>2</sup>]
- $a_{max}$  = maximum acceleration [m/s<sup>2</sup>]

#### Performance Overview

Characteristics	Unit	Description				
Series		OSP-E20BHD	OSP-E25BHD	OSP-E32BHD	OSP-E50BHD	
Max. speed	[m/s]	3 <sup>1)</sup>	5 <sup>1)</sup>	5 <sup>1)</sup>	5 <sup>1)</sup>	
Linear motion per revolution of drive shaft	[mm]	125	180	240	350	
Max. rpm on drive shaft	[min <sup>-1</sup> ]	2000	1700	1250	860	
Max. effective Action force $F_A$ at speed	< 1 m/s:	[N]	550	1070	1870	3120
	1-3 m/s:	[N]	450	890	1560	2660
	> 3 m/s:	[N]	-	550	1030	1940
No-load torque	[Nm]	0.6	1.2	2.2	3.2	
Max. acceleration/deceleration	[m/s <sup>2</sup> ]	50	50	50	50	
Repeatability	[mm/m]	±0.05	±0.05	±0.05	±0.05	
Max. standard stroke length	[mm]	5760 <sup>2)</sup>	5700 <sup>2)</sup>	5600 <sup>2)</sup>	5500 <sup>2)</sup>	

- <sup>1)</sup> up to 10 m/s on request  
<sup>2)</sup> longer strokes on request

#### Maximum Permissible Torque on Drive Shaft Speed / Stroke

OSP-E20BHD				OSP-E25BHD				OSP-E32BHD				OSP-E50BHD			
Speed [m/s]	Torque [Nm]	Stroke [m]	Torque [Nm]	Speed [m/s]	Torque [Nm]	Stroke [m]	Torque [Nm]	Speed [m/s]	Torque [Nm]	Stroke [m]	Torque [Nm]	Speed [m/s]	Torque [Nm]	Stroke [m]	Torque [Nm]
1	11	1	11	1	31	1	31	1	71	1	71	1	174	1	174
2	10	2	11	2	28	2	31	2	65	2	71	2	159	2	174
3	9	3	8	3	25	3	31	3	59	3	60	3	153	3	138
4		4	7	4	23	4	25	4	56	4	47	4	143	4	108
5		5	5	5	22	5	21	5	52	5	38	5	135	5	89

#### Important:

The maximum permissible torque on the drive shaft is the lowest value of the speed or stroke-dependent torque value.

#### Example above:

OSP-E25BHD, stroke 5 m, required speed 3 m/s from table T2  
speed 3 m/s gives 25 Nm and stroke 5 m gives 21 Nm. Max. torque for this application is 21 Nm.

#### Maximum Permissible Loads

Series	Max. applied load		Max. moments [Nm]		
	Fy[N]	Fz[N]	Mx	My	Mz
OSP-E20BHD	1600	1600	21	150	150
OSP-E25BHD	2000	3000	50	500	500
OSP-E32BHD	5000	10000	120	1000	1400
OSP-E50BHD	12000	15000	180	1800	2500

# Options and Accessories

## OSP-E..BHD Belt actuator with integrated guide

### STANDARD VERSIONS OSP-E..BHD

Standard carrier with integrated guide and magnets for contactless position sensing. Dovetail profile for mounting of accessories and the actuator itself.

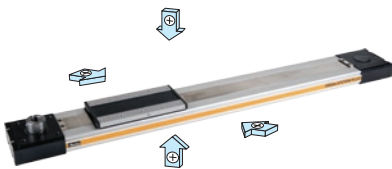

DRIVE SHAFT WITH CLAMP SHAFT

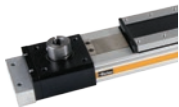

DRIVE SHAFT WITH PLAIN SHAFT



**ACTUATING DIRECTION**  
 Important in parallel operations, e.g. with intermediate drive shaft

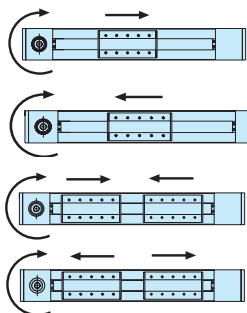

Standard

Standard - Bi-Parting Version

### OPTIONS

**TANDEM**  
 For higher moment support.



**BI-PARTING VERSION**  
 For perfectly synchronised bi-parting movements.



**DRIVE SHAFT WITH CLAMP SHAFT AND PLAIN SHAFT**  
 For connections with intermediate drive shaft

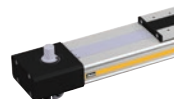

**HOLLOW SHAFT WITH KEYWAY**  
 For close coupling of motors and external gears.



**INTEGRATED PLANETARY GEARBOX**  
 For compact installation and very low backlash.

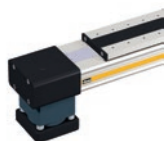

### ACCESSORIES

#### MOTOR MOUNTINGS



**END CAP MOUNTING**  
 For mounting the actuators on the end cap.



**PROFILE MOUNTING**  
 For supporting long actuators or mounting the actuators on dovetail grooves.

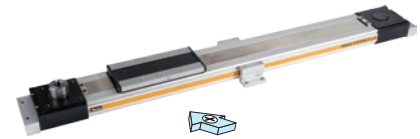

**MAGNETIC SWITCHES TYPE RS AND ES**  
 For contactless position sensing of end stop and intermediate carrier positions.

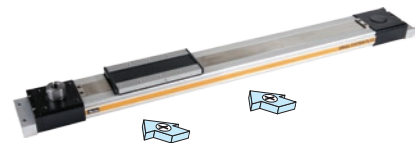

**MULTI-AXIS SYSTEMS**  
 For modular assembly of actuators up to multi-axis systems.

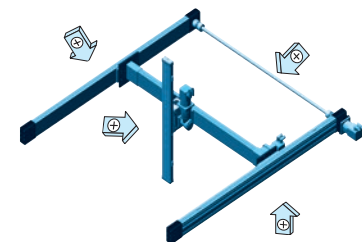

# OSP-E..B - Belt Actuator with Internal Plain Bearing Guide



## Standard Versions:

- Standard carrier with internal plain bearing guide
- Dovetail profile for mounting of accessories and the actuator itself
- Position of drive shafts

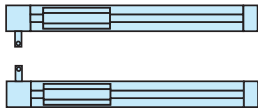

## Options:

- Tandem version
- Bi-parting version for synchronized movements
- Drive shaft with double plain shaft

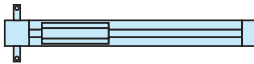

## Installation Instructions

Use the threaded holes in the end cap for mounting the actuator. See if Profile Mountings are needed using the maximum allowable unsupported length graph. At least one end cap must be secured to prevent axial sliding when profile mounting is used. When the actuator is moving an externally guided load, the compensation must be used.

The actuators can be fitted with the standard carrier mounting facing in any direction.

To prevent contamination such as fluid ingress, the actuator should be fitted with its sealing band facing downwards.

The inversion mounting can be fitted to transfer the driving force to the opposite side.

Characteristics	Description
Series	OSP-E..B
Mounting	See drawings
Ambient temperature range	-30 °C to +80 °C
Installation	See table
Encapsulation class	IP 54
<b>Material</b>	
Slotted Profile	Extruded anodized aluminium
Belt	Steel-corded polyurethane
Pulley	Aluminium
Guide bearings	Low friction plastic
Sealing band	Hardened corrosion resistant steel
Screws, nuts	Zinc plated steel
Mountings	Zinc plated steel and aluminium

## Weight (mass) and Inertia

Series	at stroke 0 m	Weight (mass) [kg]		Inertia [ $\times 10^{-6}$ kgm <sup>2</sup> ]	
		ad per meter stroke	moving mass	at stroke 0 m	ad per meter stroke
OSP-E25B	0.9	1.6	0.2	25	6.6
OSP-E32B	1.9	3.2	0.4	43	10
OSP-E50B	5.2	6.2	1.0	312	45
OSP-E25B*	1.2	1.6	0.5	48	6.6
OSP-E32B*	2.3	3.2	0.8	83	10
OSP-E50B*	6.3	6.2	2.1	585	45

\* Version: Tandem and Bi-parting (Option)

## Maintenance

All moving parts are long-term lubricated for a normal operational environment. Parker Origa recommends a check and lubrication of the actuator, and if necessary a change of the belt and wear parts, after an operation time of 12 months of operation or 3 000 km travel of distance. Additional greasing is easily done by using nipples in the slotted profile. Please refer to the operating instructions supplied with the actuator.

## First service start-up

The maximum values specified in the technical data sheet for the different products must not be exceeded. Before taking the actuator as a machine into service, the user must ensure the adherence to the EC Machine Directive 2006/42/EG.



## Sizing Performance Overview

### Maximum Loadings

#### Sizing of Actuator

The following steps are recommended for selection :

1. Required acceleration,
2. Required torque is shown on page 332
3. Check that maximum values in the table 3 are not exceeded
4. Drive shaft by using table T2. (Pay attention to note under table) If value is lower than required, overview the moving profile or select if possible a bigger unit.
5. Before sizing and specifying the motor, the average torque must be calculated using the cycle time of the application.
6. Check that the maximum allowable unsupported length is not exceeded.

#### Performance Overview

Characteristics	Unit	Description			
Size		OSP-E25B	OSP-E32B	OSP-E50B	
Max. speed	[m/s]	2	3	5	
Linear motion per revolution, drive shaft	[mm]	60	60	100	
Max. rpm drive shaft	[min <sup>-1</sup> ]	2 000	3 000	3 000	
Max. effective action force F <sub>A</sub> at speed	< 1 m/s:	[N]	50	150	425
	1 - 2 m/s:	[N]	50	120	375
	> 2 m/s:	[N]	-	100	300
No-load torque	[Nm]	0.4	0.5	0.6	
Max. acceleration/deceleration	[m/s <sup>2</sup> ]	10	10	10	
Repeatability	[mm/m]	±0.05	±0.05	±0.05	
Max. stroke length OSP-E..B	[mm]	3000	5000	5000	
Max. stroke length OSP-E..B*	[mm]	2 x 1500	2 x 2500	2 x 2500	

\* Bi-parting version

#### Maximum Permissible Torque on Drive Shaft Speed / Stroke T2

OSP-E25B				OSP-E32B				OSP-E50B			
Speed [m/s]	Torque [Nm]	Stroke [m]	Torque [Nm]	Speed. [m/s]	Torque [Nm]	Stroke [m]	Torque [Nm]	Speed. [m/s]	Torque [Nm]	Stroke [m]	Torque [Nm]
1	0.9	1	0.9	1	2.3	1	2.3	1	10.0	1	10.0
2	0.9	2	0.9	2	2.0	2	2.3	2	9.5	2	10.0
		3	0.9	3	1.8	3	2.3	3	9.0	3	9.0
						4	2.3	4	8.0	4	7.0
						5	1.8	5	7.5	5	6.0

#### Important:

The maximum permissible torque on the drive shaft is the lowest value of the speed or stroke-dependent torque value.

#### Example above:

OSP-E32B stroke 2 m, required speed 3 m/s;

From table T2: speed 3 m/s gives 1.8 Nm and stroke 2 m gives 2.3 Nm.

Max. torque for this application is 1.8 Nm.

## Loads, Forces and Moments

#### Combined loads

If the actuator is subjected to several forces, loads and moments at the same time, the maximum load is calculated with the equation shown here.

The maximum permissible loads must not be exceeded.

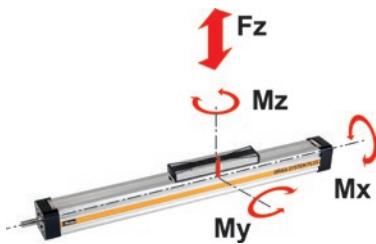

$$M = F \cdot l \text{ [Nm]}$$

$$M_x = M_{x \text{ static}} + M_{x \text{ dynamic}}$$

$$M_y = M_{y \text{ static}} + M_{y \text{ dynamic}}$$

$$M_z = M_{z \text{ static}} + M_{z \text{ dynamic}}$$

The distance l (lx, ly, lz) for calculation of the bending moments relates to the centre axis of the actuator.

#### Maximum Permissible Loads T3

Size	Max. applied load [N] Fz	Max. moments [Nm]		
		Mx	My	Mz
OSP-E25B	500	2	12	8
OSP-E32B	1200	8	25	16
OSP-E50B	3000	16	80	32
OSP-E..B Bi-partional	The maximum load F must be equally distributed among the two carriers			

#### Equation of Combined Loads

$$\frac{F_z}{F_z \text{ (max)}} + \frac{M_x}{M_x \text{ (max)}} + \frac{M_y}{M_y \text{ (max)}} + \frac{M_z}{M_z \text{ (max)}} \leq 1$$

The total of the loads must not exceed >1 under any circumstances.

# Options and Accessories

## OSP-E..B

### Belt actuator with internal plain bearing guide

#### STANDARD VERSIONS OSP-E..B

Carrier with internal guidance and magnet packet for contactless position sensing. Dovetail profile for mounting of accessories and the actuator itself.

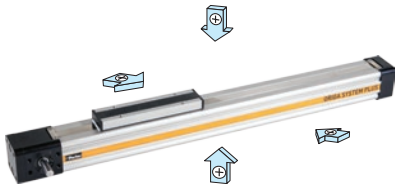

#### DRIVE SHAFT VERSIONS

- Plain shaft or
- double plain shaft (Option)  
e.g. to drive two actuators in parallel.

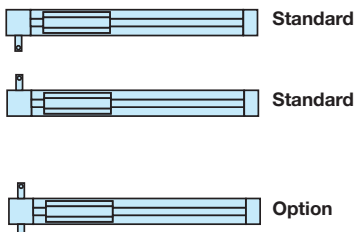

#### OPTIONS

##### TANDEM

For higher moment support.



##### BI-PARTING

For perfectly synchronised bi-parting movements.



#### ACCESSORIES

##### MOTOR MOUNTING



##### END CAP MOUNTING

For end-mounting of the actuator.



##### PROFILE MOUNTING

For supporting long actuators or mounting the actuator on the dovetail grooves.

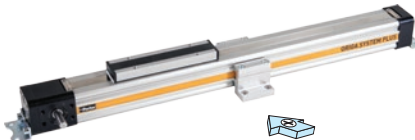

##### CLEVIS MOUNTING

Carrier with tolerance and parallelism compensation to drive external linear guides.

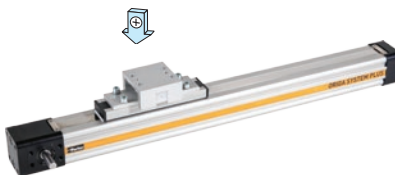

##### INVERSION MOUNTING

The inversion mounting, mounted on the carrier, transfers the driving force to the opposite side, e.g. for dirty environments.

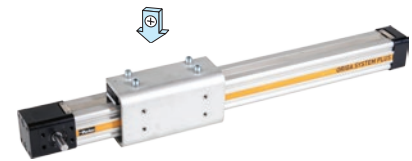

##### MAGNETIC SWITCHES

##### SERIES RST AND EST

For contactless position sensing of end stop and intermediate carrier positions.



# OSP-E..SB - Ball Screw Actuator with Internal Plain Bearing Guide



### Standard Versions:

- Standard carrier with internal plain bearing guide
- Dovetail profile for mounting of accessories and the actuator itself
- Pitches of Ball Screw Spindle  
 Type OSP-E25 : 5 mm  
 Type OSP-E32: 5 , 10 mm  
 Type OSP-E50: 5 , 10, 25 mm

### Options:

- Tandem version
- Clean room-version, according to DIN EN ISO 14644-1
- Displacement Measuring System SFI-plus

### Installation Instructions

Use the threaded holes in the end cap for mounting the actuator. See if Profile Mountings are needed using the maximum allowable unsupported length graph. At least one end cap must be secured to prevent axial sliding when profile mounting is used.

When the actuator is moving an externally guided load, the compensation must be used.

The actuators can be fitted with the standard carrier mounting facing in any direction.

To prevent contamination such as fluid ingress, the actuator should be fitted with its sealing band facing downwards.

The inversion mounting can be fitted to transfer the driving force to the opposite side.

Characteristics	Description
Series	OSP-E..SB
Ambient temperature range	-20 °C to +80 °C
Installation	In any position
Mounting	See drawing
Encapsulation class	IP 54
<b>Material</b>	
Slotted Profile	Extruded anodized aluminium
Ball screw	Hardened steel
Ball screw nut	Hardened steel
Guide bearings	Low friction plastic
Sealing band	Hardened corrosion resistant steel
Screws, nuts	Zinc plated steel
Mountings	Zinc plated steel and aluminium

### Weight (mass) and Inertia

Series	Weight (mass) [kg]			Inertia [ $\times 10^{-6}$ kgm <sup>2</sup> ]	
	at stroke 0 m	ad per meter stroke	moving mass	at stroke 0 m	ad per meter stroke
OSP-E25SB	0.8	2.3	0.2	2.2	11
OSP-E32SB	2.0	4.4	0.4	8.4	32
OSP-E50SB	5.2	9.4	1.2	84.0	225

### Maintenance

All moving parts are long-term lubricated for a normal operational environment. Parker Origa recommends a check and lubrication of the actuator, and if necessary a change of the belt and wear parts, after an operation time of 12 months of operation or 3 000 km travel of distance. Please refer to the operating instructions supplied with the actuator.

### First service start-up

The maximum values specified in the technical data sheet for the different products must not be exceeded. Before taking the actuator as a machine into service, the user must ensure the adherence to the EC Machine Directive 2006/42/EG.

## Sizing Performance Overview Maximum Loadings

### Sizing of Actuator

The following steps are recommended for selection :

1. Recommended maximum acceleration is shown in graphs
2. Required torque is shown in graphs
3. Check that maximum values in the adjacent charts are not exceeded.
4. When sizing and specifying the motor, the RMS-average torque must be calculated using the cycle time of the application.
5. Check that the maximum allowable unsupported length is not exceeded.

### Performance Overview

Characteristics	Unit	Description					
		OSP-E25SB	OSP-E32SB		OSP-E50SB		
Series		OSP-E25SB	OSP-E32SB		OSP-E50SB		
Pitch	[mm]	5	5	10	5	10	25
Max. speed	[m/s]	0.25	0.25	0.5	0.25	0.5	1.25
Linear motion per revolution drive shaft	[mm]	5	5	10	5	10	25
Max. rpm, drive shaft	[min <sup>-1</sup> ]	3 000	3 000		3 000		
Max. effective action force $F_A$	[N]	250	600	1 500			
Corresponding torque on drive shaft	[Nm]	0.35	0.75	1.3	1.7	3.1	7.3
No-load torque	[Nm]	0.2	0.2	0.3	0.3	0.4	0.5
Max. allowable torque on drive shaft	[Nm]	0.6	1.5	2.8	4.2	7.5	20
Repeatability	[mm/m]	±0.05	±0.05		±0.05		
Max. Standard stroke length	[mm]	1100	2000		3200		

# OSP-E..ST - Trapezoidal Screw Actuator with Internal Plain Bearing Guide



## Standard Versions:

- Standard carrier with internal plain bearing guide
- Dovetail profile for mounting of accessories and the actuator itself
- Pitch of Trapezoidal Spindle:  
Type OSP-E25ST: 4 mm  
Type OSP-E32ST: 4 mm  
Type OSP-E50ST: 6 mm

## Options:

- Displacement Measuring System SFI-plus
- Keyway

## Installation Instructions

Use the threaded holes in the free end cap and a profile mounting close to the motor end for mounting the actuator. See if profile mountings are needed using the maximum permissible unsupported length graph.

At least one end cap must be secured to prevent axial sliding when Profile Mounting is used.

When the actuator is moving an externally guided load, the compensation must be used.

The actuators can be fitted with the standard carrier mounting facing in any direction.

To prevent contamination such as fluid ingress, the drive should be fitted with its sealing band facing downwards.

The inversion mounting can be fitted to transfer the driving force to the opposite side.

Characteristics	Description
Series	OSP-E..ST
Mounting	See drawings
Ambient temperature range	-20 °C to +70 °C
Installation	In any position
<b>Material</b>	
Slotted Profile	Extruded anodized aluminium
Trapezoidal screw	Cold rolled steel
Drive nut	Thermoplastic polyester
Guide bearings	Low friction plastic
Sealing band	Hardened corrosion resistant steel
Screws, nuts	Zinc plated steel
Mountings	Zinc plated steel and aluminium

## Weight (mass) and Inertia

Series	Weight (mass) [kg]			Inertia [ $\times 10^{-6}$ kgm <sup>2</sup> ]	
	at stroke 0 m	ad per meter stroke	moving mass	at stroke 0 m	ad per meter stroke
OSP-E25ST	0.9	2.8	0.2	6	30
OSP-E32ST	2.1	5.0	0.5	21.7	81
OSP-E50ST	5.1	10.6	1.3	152	400

## Maintenance

All moving parts are long-term lubricated for a normal operational environment. Parker Origa recommends a check and lubrication of the actuator, and if necessary a change of the belt and wear parts, after an operation time of 12 months of operation or 3000 km travel of distance.

Please refer to the operating instructions supplied with the drive

## First service start-up

The maximum values specified in the technical data sheet for the different products must not be exceeded. Before taking the actuator as a machine into service, the user must ensure the adherence to the EC Machine Directive 2006/42/EG.

## Sizing Performance Overview Maximum Loadings

### Sizing of Actuator

The following steps are recommended for selection :

1. Check that maximum values in the table T3 are not exceeded.
2. Check the maximum values in graph are not exceeded.
3. When sizing and specifying the motor, the RMS-average torque must be calculated using the cycle time of the application.
4. Check that the maximum allowable unsupported length is not exceeded

### Performance Overview

Characteristics	Unit	Description		
		OSP-E25ST	OSP-E32ST	OSP-E50ST
Size		OSP-E25ST	OSP-E32ST	OSP-E50ST
Pitch	[mm]	4	4	6
Max. speed	[m/s]	0.1	0.1	0.15
Linear motion per revolution drive shaft	[mm]	4	4	6
Max. rpm, drive shaft	[min-1]	1500	1500	1500
Max. effective action force FA	[N]	600	1300	2 500
Corresponding torque on drive shaft	[Nm]	1.35	3.2	8.8
No-load torque	[Nm]	0.3	0.4	0.5
Max. allowable torque on drive shaft	[Nm]	1.55	4.0	9.4
Self-locking force FL1)	[N]	600	1300	2500
Repeatability	[mm/m]	±0.5	±0.5	±0.5
Max. Standard stroke length	[mm]	1100	2000	2500*

<sup>1)</sup> Related to screw types Tr 16x4, Tr 20x4, TR 30x6

\* For strokes longer than 2000 mm in horizontal applications, please contact our customer support.



# OSP-E..BV - Vertical Belt Actuator with Integrated Ball Bearing Guide



## Standard Versions:

- Vertical belt actuator with integrated ball bearing guide
- Drive shaft with clamp shaft or plain shaft
- Choice of motor mounting side

## Options:

- Tandem version for higher moments
- Drive shaft with
  - clamp shaft and plain shaft or double plain shaft
  - hollow shaft with keyway
- Special drive shaft versions on request

## Installation Instructions

Make sure that the OSP-E..BV is always operated by motor with holding brake on the actuator side. For the mounting of the external mass to be moved there are threaded holes in the end caps. Before mounting, check the correct centre of gravity distance from the table.

Mount the external mass on the belt fixed end, so that the belt tension can be checked and adjusted at the belt tensioning end without dismantling.

Characteristics	Description
Series	OSP-E..BV
Mounting	See drawings
Ambient temperature range	-30 °C to +80 °C
Installation	Vertical
Encapsulation class	IP 20
<b>Material</b>	
Profile	Extruded anodized aluminium
Belt	Steel-corded polyurethane
Pulley	Aluminium
Guide	Ball bearing guide
Guide rail	Hardened steel rail with high precision, accuracy class N
Guide carrier preloaded 0.08 x C, accuracy class N	Steel carrier with integrated wiper system, grease nipples,
Screws, nuts	Zinc plated steel

## Weight (mass) and Inertia

Series	Total weight (Mass) [kg]		Moving mass [kg]		Inertia [ $\times 10^{-6}$ kgm <sup>2</sup> ]		
	At stroke 0 m	Actuator head	At stroke 0 m	Add per metre stroke	At Stroke 0 m	Add per metre stroke	Add per kg mass
OSP-E20BV	3.4	1.9	1.6	4.0	486	1144	289
OSP-E25BV	7.7	5.3	2.4	4.4	1695	2668	617
OSP-E20BV*	5.3	2 x 1.9	1.6	4.0	533	1144	289
OSP-E25BV*	13	2 x 5.3	2.4	4.4	1915	2668	617

\* Version: Tandem (Option)

## Maintenance

Depending on operating conditions, inspection of the actuator is recommended after 12 months or 3000 km operation. Please refer to the operating instructions supplied with the actuator.

## First service start-up

The maximum values specified in the technical data sheet for the different products must not be exceeded. Before taking the actuator as a machine into service, the user must ensure the adherence to the EC Machine Directive 2006/42/EG.

## Sizing Performance Overview

### Maximum Loadings

#### Sizing of Actuator

The following steps are recommended for selection :

1. Determination of the lever arm length  $l_x$ ,  $l_y$  and  $l_z$  from  $m_e$  to the centre axis of the actuator.
2. Calculation of the static and dynamic force  $F_A$  which must be transmitted by the belt.  

$$F_A = F_g + F_a + F_0$$

$$= m_g \cdot g + m_g \cdot a + M_0 \cdot 2\pi / U_{ZR}$$
3. Calculation of all static and dynamic moments  $M_x$ ,  $M_y$  and  $M_z$  which occur in the application.  

$$M = F \cdot l$$
4. Selection of maximum permissible loads via Table T3.
5. Calculation and checking of the combined load, which must not be higher than 1.
6. Checking of the maximum moment that occurs at the drive shaft in Table T2.
7. Checking of the required action force  $F_A$  with the permissible load value from Table T1.

For motor sizing, the effective torque must be determined, taking into account the cycle time.

#### Legend

- $l$  = distance of a mass in the x-, y- and z-direction from the guide [m]
- $m_e$  = external moved mass [kg]
- $m_{LA}$  = moved mass of actuator [kg]
- $m_g$  = total moved mass ( $m_e + m_{LA}$ ) [kg]
- $F_A$  = action force [N]
- $M_0$  = no-load torque [Nm]
- $U_{ZR}$  = circumference of the pulley (linear movement per revolution) [m]
- $g$  = gravity [m/s<sup>2</sup>]
- $a_{max}$  = maximum acceleration [m/s<sup>2</sup>]

#### Performance Overview

Characteristics	Unit	Description		
Series		OSP-E20BV	OSP-E25BV	
Max. Speed	[m/s]	3.0	5.0	
Linear motion per revolution of drive shaft	[mm/U]	108	160	
Max. rpm. drive shaft	[min <sup>-1</sup> ]	1700	1875	
Max. effective action force $F_A$ at speed	1 m/s	[N]	650	1430
	1 - 2 m/s	[N]	450	1200
	> 3 - 5 m/s	[N]	–	1050
No-load torque <sup>2)</sup>	[Nm]	0.6	1.2	
Max. acceleration/deceleration	[m/s <sup>2</sup> ]	20	20	
Repeatability	+/- [mm/m]	0.05	0.05	
Max. standard stroke length <sup>1)</sup>	[mm]	1000	1500	
Max. recommended permissible mass <sup>3)</sup>	[kg]	10	20	

<sup>1)</sup> Longer strokes on request

<sup>2)</sup> As a result of static friction force

<sup>3)</sup> vertical

#### Maximum Permissible Torque on Drive Shaft Speed / Stroke

OSP-E-20BV				OSP-E-25BV			
Speed [m/s]	Torque [Nm]	Stroke [m]	Torque [Nm]	Speed [m/s]	Torque [Nm]	Stroke [m]	Torque [Nm]
1	19	1	17	1	36	1	36
2	17	2	11	2	30	2	36
3	16			3	30		
				4	28		
				5	27		

#### Important:

The maximum permissible torque on the drive shaft is the lowest value of the speed or stroke-dependent torque value.

#### Example above:

OSP-E25BV required speed  $v = 3$  m/s and stroke = 1 m.

Accordingly Table T2 shows permissible moments of 30 Nm for the speed and 36 Nm for the stroke. Therefore the maximum moment at the drive shaft is determined by the speed and must not exceed 30 Nm.

## Loads, Forces and Moments

### Combined loads

If the actuator is subjected to several forces, loads and moments at the same time, the maximum load is calculated with the equation shown here.

The maximum permissible loads must not be exceeded.

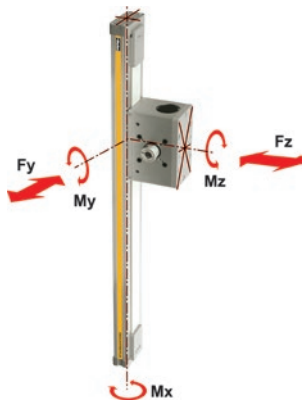

$$M = F \cdot l \text{ [Nm]}$$

$$M_x = M_{x \text{ static}} + M_{x \text{ dynamic}}$$

$$M_y = M_{y \text{ static}} + M_{y \text{ dynamic}}$$

$$M_z = M_{z \text{ static}} + M_{z \text{ dynamic}}$$

The distance  $l$  ( $l_x$ ,  $l_y$ ,  $l_z$ ) for calculation of the bending moments relates to the centre axis of the actuator.

### Maximum Permissible Loads

Size	Max. applied load [N]		Max. moments [Nm]		
	Fy [N]	Fz [N]	Mx	My	Mz
OSP-E20BV	1600	1600	20	100	100
OSP-E25BV	2000	3000	50	200	200

### Equation of Combined Loads

$$\frac{F_z}{F_z \text{ (max)}} + \frac{M_x}{M_x \text{ (max)}} + \frac{M_y}{M_y \text{ (max)}} + \frac{M_z}{M_z \text{ (max)}} \leq 1$$

The total of the loads must not exceed >1 under any circumstances.

### Distance of Centre of Gravity of External Mass from Mid-Point of Actuator

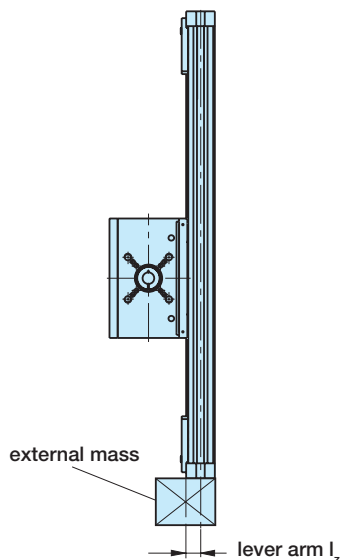

Mass [kg]	OSP-E20BV		OSP-E25BV	
	Lever arm $l_z$ [mm]	Max. permissible acceleration/ deceleration [m/s <sup>2</sup> ]	Lever arm $l_z$ [mm]	Max. permissible acceleration/ deceleration [m/s <sup>2</sup> ]
> 3 to 5	0	20	50	20
> 5 to 10	0	20	40	20
> 10 to 15	-	-	35	20
> 15 to 20	-	-	30	15

# Options and Accessories

## OSP-E..BV, Vertical belt actuator with integrated ball bearing guide

### STANDARD VERSION OSP-E..BV

Standard actuator head with clamp shaft or plain shaft and integrated ball bearing guide with two carriers.  
 Choice of side on which gearbox or motor is to be mounted.

**DRIVE SHAFT**  
 "CLAMP SHAFT AND PLAIN SHAFT" OR "DOUBLE PLAIN SHAFT"  
 e.g. for parallel operation of two Z-axes with an intermediate drive shaft.

### ACCESSORIES

**MOTOR MOUNTINGS**  
 For connection of gearbox or motor direct to drive shaft with clamp shaft, or with a motor coupling to drive shaft with plain shaft.

Drive Shaft with Clamp Shaft



Drive Shaft with Plain Shaft



Drive Shaft with Clamp Shaft and Plain Shaft



Drive Shaft with Double Plain Shaft



**MAGNETIC SWITCHES SET**  
 Magnetic switches with connector, mounting rail and magnets for contactless sensing of the end positions. Cable (suitable for cable chain) can be ordered separately in 5 m, 10 m or 15 m length.

### OPTIONS

**TANDEM**  
 Additional actuator head and two additional carriers for higher bending moments.



**HOLLOW SHAFT WITH KEYWAY**  
 For direct connection of gearbox or motor with keyway.

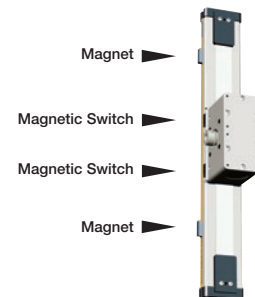

**MULTI-AXIS SYSTEMS**  
 For modular assembly of actuators up to multi-axis systems.

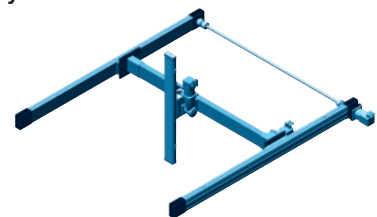

## LCB - Compact Linear Actuator with Sliding Bearing

- Robust and compact linear actuator
- Cost-efficient positioning actuator
- External sliding guide and toothed belt drive
- Low maintenance and low noise
- Simple mounting
- Clean operation without lubricants
- High resistance to flexing
- Very high torsional rigidity
- Dirt tolerant
- Easy maintenance, robust



The linear actuators are available in two sizes: LCB040 and LCB060  
 The modular system allows the combination of actuators including other types of actuator to build complete handling systems.

### Specifications

Frame sizes		LCB040	LCB060
<b>Rating</b>			
Maximum thrust force	[N]	160	560
Typical payload	[kg]	1...6	1...30
Max. static load bearing capacity	[N]	1250	3850
Max. Stroke	[mm]	2000	5500
Max. Speed	[m/s]	5	8
Repeatability	[mm]	±0.2	±0.2
Max. Acceleration	[m/s <sup>2</sup> ]	20	20
Travel distance per revolution	[mm/U]	125	170
Toothed belt width / pitch	[mm]	16/5	25/10
Maximum drive torque	[Nm]	3.2	15.2
<b>Weight of base unit without stroke</b>			
LCB with short sliding carriage	[kg]	1.47	4.33
LCB with medium sliding carriage	[kg]	1.66	4.71
LCB with long sliding carriage	[kg]	1.85	5.10
Weight of moved mass with short sliding carriage	[kg]	0.39	1.41
Weight of moved mass with medium sliding carriage	[kg]	0.46	1.53
Weight of moved mass with long sliding carriage	[kg]	0.53	1.66
Additional weight per meter of stroke	[kg/m]	2.45	5.21
<b>Overall dimensions &amp; physical data</b>			
Length with short sliding carriage, zero stroke	[mm]	246	378
Length with medium sliding carriage, zero stroke	[mm]	296	428
Length with long sliding carriage, zero stroke	[mm]	346	478

## Dimensions

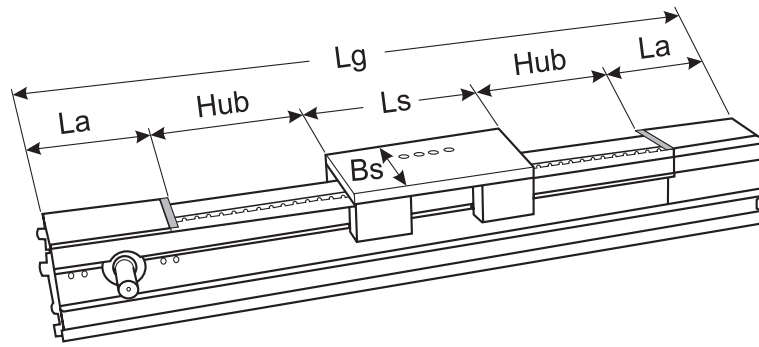

		LCB040	LCB060
Short sliding carriage Ls	[mm]	100	150
Medium sliding carriage Ls	[mm]	150	200
Long sliding carriage Ls	[mm]	200	250
Width of sliding carriage Bs	[mm]	73	120
Module stop La	[mm]	73	114
Total length Lg	[mm]	stroke + Ls + 2 La	stroke + Ls + 2 La
max. Stroke	[mm]	2000	5500

## Section

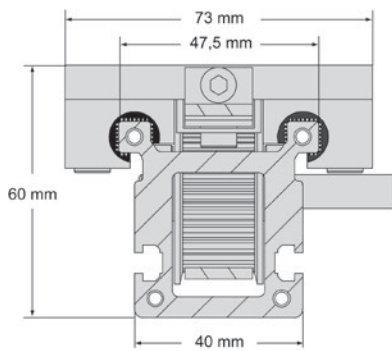

LCB040

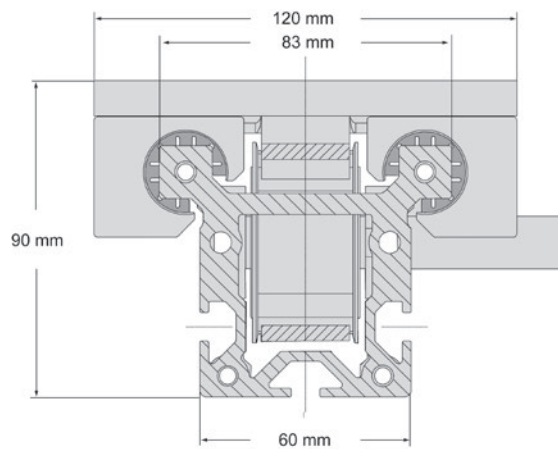

LCB060

## Stroke lengths

possible stroke lengths [mm]															
Stroke	250	300	350	400	450	500	600	700	800	900	1000	1250	1500	1750	2000
LCB040	x	x	x	x	x	x	x	x	x	x	x	x	x	x	x
LCB060	x	x	x	x	x	x	x	x	x	x	x	x	x	x	x
Stroke	2250	2500	2750	3000	3250	3500	3750	4000	4250	4500	4740	5000	5250	5500	
LCB060	x	x	x	x	x	x	x	x	x	x	x	x	x	x	

When determining the stroke, a safety travel on both sides of the travel path should be considered.

# LCR - Light Capacity Rodless Miniature Linear Positioner

## Description

For OEMs looking to automate light payloads, the LCR (Light Capacity Rodless) linear positioner family provides the smallest form factor with unmatched, easy-to-use flexibility.

LCR was developed specifically to provide a high-quality, easy-to-use, off-the-shelf linear actuator. Rated for 100 % duty cycle, the LCR offers smooth, quiet motion ideal for keeping instrument noise to a minimum. With selectable travel lengths up to 1000 mm and payloads up to 100 N, the ability to automate laboratory instruments has never been easier.



## Features

- Miniature footprint - 30x40 mm cross-section
- Internal square rail or glider bearing design
- 100 % duty cycle
- IP30 stainless steel strip seal
- Low noise leadscrew drive
- Long travel belt drive
- Travel lengths to 1000 mm
- Attractive black anodize finish
- Extruded aluminum body incorporates dovetail mounting, T-slots and belt return
- Toe clamp mounting for easy installation
- Dowel pin holes in the LCR30 carriage for repeatable mounting
- Multiple motor mount options accommodate NEMA 11, 17 and 23 steppers
- Flush-mounted fully adjustable limit sensors

## Application

- Life science
- General-purpose applications

## Technical Characteristics - Overview

LCR - Linear Positioner	Screw-Driven	Belt-Driven
Model	LCR30	
Width x Height [mm]	30x40	
Repeatability [mm]	±0.1	±0.5
Max. Normal Load [N]	100	
Max. Axial Load [N]	60	45
Max. Speed [mm/s]	150	900
Max. Travel Length [mm]	600	1000
Screw Lead Options [mm/rev]	2, 10	-
Conformity	CE, RoHS	





## Technical Data - LCR Screw-Driven

### LCR Screw-Driven

Type	Unit	LCR30	
		S (Square Rail)	B (Bushing)
<b>Bidirectional Repeatability</b>	[mm]	±0.1	±0.2
<b>Duty Cycle</b>	[%]	100	100
<b>Max. Acceleration*</b>	[m/s <sup>2</sup> ]	20	20
<b>Normal Load</b>		90	45
<b>Moment Load</b>	[Nm]		
Roll		2.6	0.3
Yaw		6.5	0.8
Pitch		8.2	1.5
<b>Max. Axial Load</b>	[N]	70	70
<b>Screw Efficiency</b>	[%]		
2.0 mm Lead		50	50
10.0 mm Lead		70	70
<b>Breakaway Torque</b>	[mNm]	30 (2 mm lead) 45 (10 mm lead)	40 (2 mm lead) 90 (10 mm lead)
<b>Screw Diameter</b>	[mm]	6.4	6.4
<b>Coefficient of Friction</b>	-	0.02	0.10
<b>Base Moment of Inertia</b>	[mm <sup>4</sup> ]		
I <sub>xx</sub>		39 778	36 162
I <sub>yy</sub>		46 273	42 066

\* Do not exceed allowable axial and moment loading.

## Technical Data - LCR Belt-Driven

### LCR Belt-Driven

Type	Unit	LCR30	
		S (Square Rail)	B (Bushing)
<b>Bidirectional Repeatability</b>	[mm]	±0.2	±0.5
<b>Duty Cycle</b>	[%]	100	100
<b>Max. Acceleration*</b>	[m/s <sup>2</sup> ]	20	20
<b>Max. Linear Speed</b>	[mm/s]	870	870
<b>Normal Load</b>	[N]	90	45
<b>Moment Load</b>	[Nm]		
Roll		2.6	0.3
Yaw		6.5	0.8
Pitch		8.2	1.5
<b>Max. Axial Load</b>	[N]	45	45
<b>Linear Travel/Rev</b>	[mm]	58.0	58.0
<b>Breakaway Torque</b>	[mNm]	85.0	85.0
<b>Coefficient of Friction</b>	-	0.02	0.10
<b>Base Moment of Inertia</b>	[mm <sup>4</sup> ]		
I <sub>xx</sub>		39 778	36 162
I <sub>yy</sub>		46 273	42 066

\* Do not exceed allowable axial and moment loading.

# HMR - Electromechanical Linear Actuator



## Profile designs

- Basic profile for assembling directly to the machine base
- Reinforced profile for self-supporting assembly



## Mounting systems

- Integrated T-slots for attaching from below and from the side

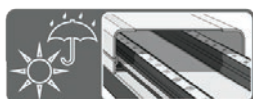

## Protection classes

- Without cover: Standard
- With cover: IP54



## Guide system

- Recirculating ball bearing guide



## Lubrication

- Central lubrication via externally accessible lubricating nipples

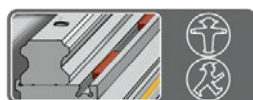

## Position sensing

- Integrated, adjustable position switch for end positions and homing



## Impact protection

- Integrated shock absorbers for both end positions

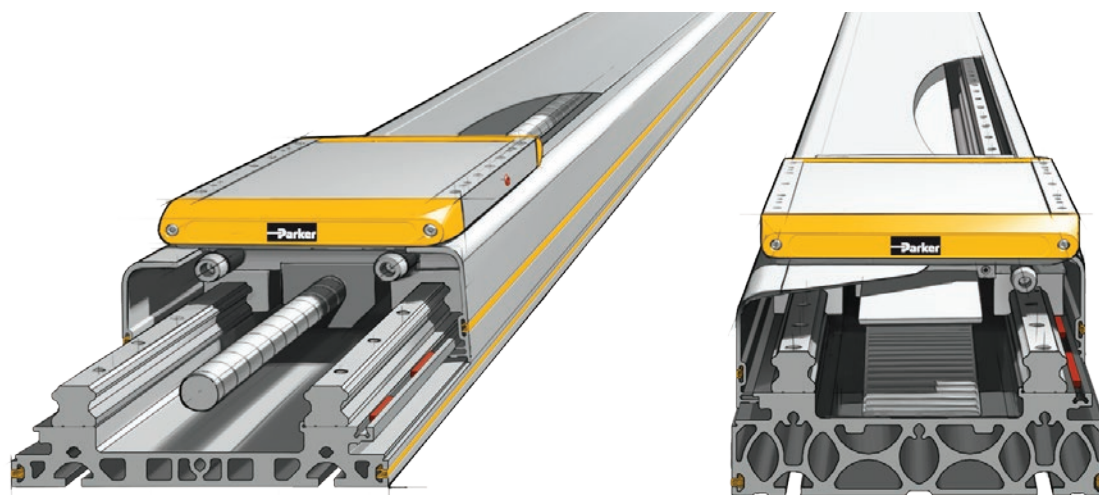

## Screw drive

The solution for precise path and position control for heavy loads



## Toothed belt drive

The solution for fast path and position control for medium loads

Sizes 85, 110, 150, 180, 240 mm

### Load requirements for guides and installation size.

The occurring loads, forces and bending moments depend on the application. The mass of the construction attached to the carriage has a center of gravity. This mass creates static forces ( $F = m \cdot g$ ) and bending moments ( $M = m \cdot g \cdot l$ ). Additional dynamic moments ( $M = m \cdot a \cdot l$ ) arise in dependence of the acceleration during travel. Care should be taken when selecting suitable guides that the permissible sum of loads does not exceed 1.

### Loads, forces and bending moments

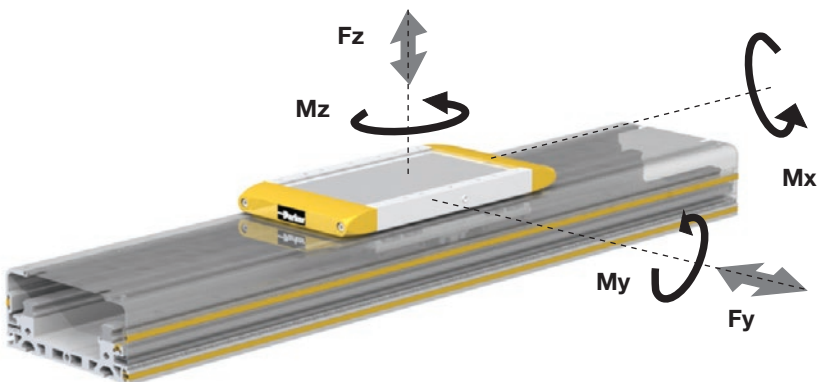

Internal lever arm  $l_{zi}$

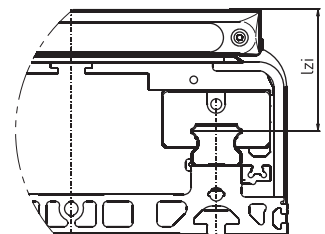

Dimensions - Internal lever arm  $l_{zi}$

Product size	[mm]	$l_{zi}$
HMRx085	[mm]	33.0
HMRx110	[mm]	39.5
HMRx150	[mm]	50.0
HMRx180	[mm]	57.5
HMRx240	[mm]	68.0

### Combined loads

The maximum permissible load for linear drives subject to simultaneous multiple

loads, forces and bending moments are calculated using the formula below.

$$L = \frac{F_y}{F_{y(max)}} + \frac{F_z}{F_{z(max)}} + \frac{M_x}{M_{x(max)}} + \frac{M_y}{M_{y(max)}} + \frac{M_z}{M_{z(max)}} \leq 1$$

Maximum permissible loads must not be exceeded.

The sum of all loads must under no circumstance be  $> 1$ .

**Maximum permissible loads based on a performance of 2,540 km**

Product Size		HMRx08	HMRx11	HMRx15	HMRx18	HMRx24	HMRx08	HMRx11	HMRx15	HMRx18	HMRx24
<b>Carriage</b>		<b>Standard</b>					<b>Tandem</b>				
<b>Max. permissible load</b>											
$F_{z2540}$ $F_{y2540}$	[N]	1,800	4,450	8,800	16,200	26,600	2,700	6,700	13,200	24,300	39,900
<b>Max. permissible bending moment</b>											
$M_{x2540}$	[Nm]	45	155	430	940	2,150	68	235	645	1,410	3,225
$M_{y2540}$ $M_{z2540}$	[Nm]	80	200	560	1,230	2,430	120	300	840	1,845	3,645

**Maximum permissible loads based on a performance of 8,000 km**

Product Size		HMRx08	HMRx11	HMRx15	HMRx18	HMRx24	HMRx08	HMRx11	HMRx15	HMRx18	HMRx24
<b>Carriage</b>		<b>Standard</b>					<b>Tandem</b>				
<b>Max. permissible load</b>											
$F_{z8000}$ $F_{y8000}$	[N]	1,250	3,000	6,000	11,000	18,200	1,875	4,500	9,000	16,500	27,300
<b>Max. permissible bending moment</b>											
$M_{x8000}$	[Nm]	30	105	290	640	1,460	45	160	435	960	2,190
$M_{y8000}$ $M_{z8000}$	[Nm]	55	135	380	840	1,660	80	205	570	1,260	2,490

## Series HMRS / Ball Screw / Drive Data



### Series HMRS / Ball Screw / Drive Data / Sizes 85, 110, 150, 180, 240 mm

#### Technical Data HMRS

Product Size			HMRS08		HMRS11		HMRS15		HMRS18		HMRS24	
Type of Screw			12 x 5	12 x 12	16 x 5	16 x 16	20 x 5	20 x 20	25 x 10	25 x 25	32 x 10	32 x 32
Pitch	p	[mm]	5	12	5	16	5	20	10	25	10	32
Max. speed	v <sub>max.</sub>	[m/s]	0.25	0.60	0.25	0.80	0.25	1.00	0.50	1.25	0.50	1.60
Max. acceleration	a <sub>max.</sub>	[m/s <sup>2</sup> ]	10		10		10		10		10	
Repeatability		[μm]	± 20		± 20		± 20		± 20		± 20	
Max. stroke		[mm]	1,200		1,500		2,500		3,400		4,000	
Thrust force and torque												
Max. thrust force	F <sub>Amax</sub>	[N]	820	820	2,200	2,200	2,600	2,600	4,800	4,800	5,500	5,500
	F <sub>A2540</sub>	[N]	820	650	1,550	1,150	1,800	2,160	3,300	3,960	3,500	4,880
Max. torque at drive shaft	M <sub>Amax</sub>	[Nm]	0.7	1.7	1.9	6.1	2.2	9.0	8.3	20.8	9.5	30.4
	M <sub>A2540</sub>	[Nm]	0.7	1.3	1.3	3.1	1.6	7.5	5.7	17.1	6.1	27.0
No load torque	M <sub>0</sub>	[Nm]	0.2	0.2	0.3	0.4	0.7	0.9	0.9	1.0	1.0	1.1
Stroke dependent speed												
Max. permissible speed at order stroke	200	[mm]	250	600	250	800	250	1,000	500	1,250	500	1,600
	400	[mm]	250	600	250	800	250	1,000	500	1,250	500	1,600
	600	[mm]	152	366	197	631	250	1,000	500	1,250	500	1,600
	800	[mm]	102	245	132	424	169	678	382	956	423	1,354
	1000	[mm]	73	176	95	304	122	486	277	694	312	997
	1200	[mm]	55	132	71	228	91	366	211	526	239	765
	1400	[mm]	-	-	56	178	71	285	165	413	189	605
	1600	[mm]	-	-	45	143	57	228	133	333	153	491
	1800	[mm]	-	-	-	-	47	187	109	274	127	406
	2000	[mm]	-	-	-	-	39	156	92	229	107	342
	2200	[mm]	-	-	-	-	33	132	78	195	91	291
	2400	[mm]	-	-	-	-	28	113	67	167	79	251
	2600	[mm]	-	-	-	-	-	-	58	145	68	219
	2800	[mm]	-	-	-	-	-	-	51	128	60	193
	3000	[mm]	-	-	-	-	-	-	45	113	53	171
	3200	[mm]	-	-	-	-	-	-	40	100	48	152
	3400	[mm]	-	-	-	-	-	-	-	-	43	137
3600	[mm]	-	-	-	-	-	-	-	-	39	123	
3800	[mm]	-	-	-	-	-	-	-	-	35	112	
4000	[mm]	-	-	-	-	-	-	-	-	32	102	

## Series HMRB / Belt / Drive Data

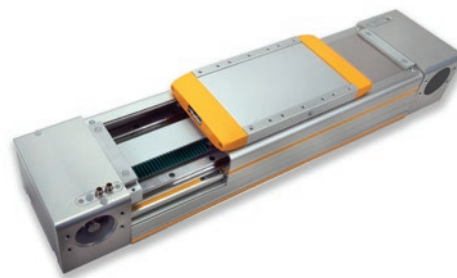

### Description Motor mounting position

<b>horizontal</b>		<b>upright</b>	
<b>090° / 270°</b>		<b>000° / 180°</b>	
<b>BD, DD</b>		<b>AP, CP, AD, CD</b>	

Type and orientation of the belt is given by the motor mounting position.

### Technical data HMRB

Production size			HMRB08		HMRB11		HMRB15	
Motor mounting position			090° / 270°	000° / 180°	090° / 270°	000° / 180°	090° / 270°	000° / 180°
Lead constant	$s_{in.}$	[mm]	66	66	90	90	100	125
Max. speed	$v_{max.}$	[m/s]			2		5	
Max. acceleration	$a_{max.}$	[m/s <sup>2</sup> ]			30		50	
Repeatability		[μm]			± 50			
Max. order stroke		[mm]	3,000		4,000		6,000	
Thrust force and torque								
Max. thrust force	$F_{Amax.}$	[N]	295	295	630	630	1,050	630
Max. torque on drive shaft	$M_{Amax.}$	[Nm]	3.1	3.1	9.0	9.0	17.0	13.0
No load torque	$M_0$	[Nm]	1.0	1.0	1.2	1.2	1.2	1.2

### Technical data HMRB

Production size			HMRB18		HMRB24	
Motor mounting position			090° / 270°	000° / 180°	090° / 270°	000° / 180°
Lead constant	$s_{in.}$	[mm]	130	150	160	224
Max. speed	$v_{max.}$	[m/s]			5	
Max. acceleration	$a_{max.}$	[m/s <sup>2</sup> ]			50	
Repeatability		[μm]			± 50	
Max. order stroke		[mm]			6,000	
Thrust force and torque						
Max. thrust force	$F_{Amax.}$	N	1,300	1,000	4,000	3,750
Max. torque on drive shaft	$M_{Amax.}$	Nm	27	24	101	134
No load torque	$M_0$	Nm	2.0	2.0	4.0	4.0

## Series HMRB / Belt / Thrust Force

The permissible thrust force from the table is depending on speed level and order stroke length. The minimum thrust force value must not be exceeded in the application.

Information: Limiting the torque from the motor may avoid exceeding permitted thrust force.

### HMRB thrust force

Product size			HMRB08		HMRB11		HMRB15		HMRB18		HMRB24	
Motor mounting position			090° / 270°	000° / 180°	090° / 270°	000° / 180°	090° / 270°	000° / 180°	090° / 270°	000° / 180°	090° / 270°	000° / 180°
Thrust force $F_A$ corresponding to speed $v$	$F_{A(v<1 \text{ m/s})}$	[N]	295	295	630	630	1,050	630	1,300	1,000	4,000	3,750
	$F_{A(v<2 \text{ m/s})}$	[N]	295	295	550	550	990	630	1,300	1,000	4,000	3,380
	$F_{A(v<3 \text{ m/s})}$	[N]	-	-	-	-	930	630	1,300	1,000	3,650	3,140
	$F_{A(v<4 \text{ m/s})}$	[N]	-	-	-	-	890	630	1,300	1,000	3,370	2,950
	$F_{A(v<5 \text{ m/s})}$	[N]	-	-	-	-	840	630	1,300	1,000	3,200	2,800
Thrust force $F_A$ corresponding to order stroke length OS	$F_{A(OS<1000 \text{ mm})}$	[N]	250	250	630	630	1,050	630	1,300	1,000	4,000	3,750
	$F_{A(OS<2000 \text{ mm})}$	[N]	140	140	550	550	820	490	1,000	775	4,000	3,360
	$F_{A(OS<3000 \text{ mm})}$	[N]	100	100	385	385	570	340	710	550	3,370	2,440
	$F_{A(OS<4000 \text{ mm})}$	[N]	-	-	295	295	445	265	550	430	2,860	1,880
	$F_{A(OS<5000 \text{ mm})}$	[N]	-	-	-	-	365	215	450	350	2,350	1,540
	$F_{A(OS<6000 \text{ mm})}$	[N]	-	-	-	-	305	185	380	295	2,000	1,300

**Example:**

HMRB18 with motor mounting position 1 (090° front), speed  $v = 2 \text{ m/s}$  ( $F_A = 1,300 \text{ N}$ ) and order stroke length OS = 2,500 mm ( $F_A = 710 \text{ N}$ ).  
The maximum permissible thrust force  $F_A = 710 \text{ N}$  must not be exceeded.



*HMR Series*  
*Profile Versions*  
*Sizes 85, 110, 150, 180, 240 mm*

**Designs**

- **Basic**
- **Reinforced**

The HMR linear drive system can be equipped with a “basic” or “reinforced” profile as standard. The “basic” profile is suitable for fitting directly to a machine base that has a corresponding support surface. The “reinforced” profile, on the other hand, is the preferred choice for self-supporting systems or for use in conjunction with a base surface offering limited support. The permissible temperature range for both profile versions is -20°C ... +80°C.

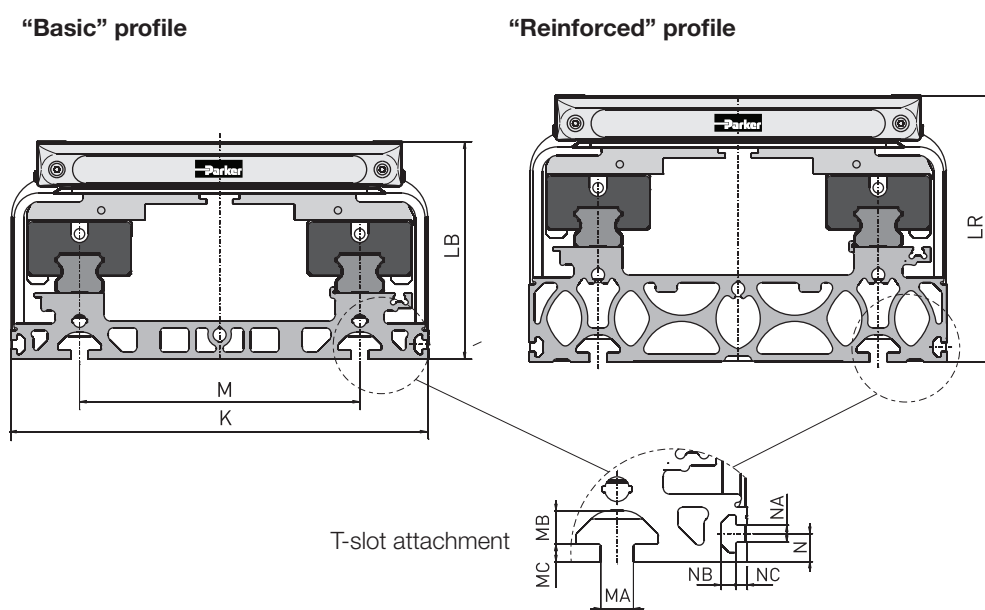

**Dimensions - Profil design HMR**

Product Size		K	LB	LR	M	MA	MB	MC	N	NA	NB	NC
HMRx085	[mm]	85.0	60.0	71.0	50.0	5.2	4.5	1.5	4.5	3.4	3.0	2.5
HMRx110	[mm]	110.0	69.5	89.5	70.0	5.2	4.5	1.8	4.5	3.4	3.0	2.5
HMRx150	[mm]	150.0	90.0	114.0	96.0	6.2	6.8	3.0	6.5	5.2	4.6	3.5
HMRx180	[mm]	180.0	111.5	134.5	116.0	8.0	7.8	4.5	8.5	5.2	4.5	3.5
HMRx240	[mm]	240.0	125.0	153.0	161.0	10.0	10.2	5.3	8.5	5.2	4.5	3.5

HMR Series  
Profile version „reinforced“  
Sizes 85, 110, 150, 180, 240 mm

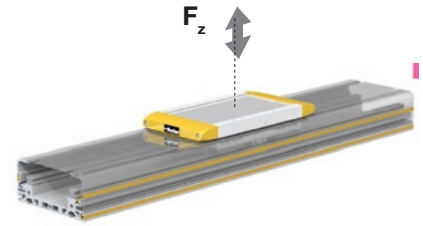

Max. admissible loads [N] and supporting distances [mm] (self-supporting)

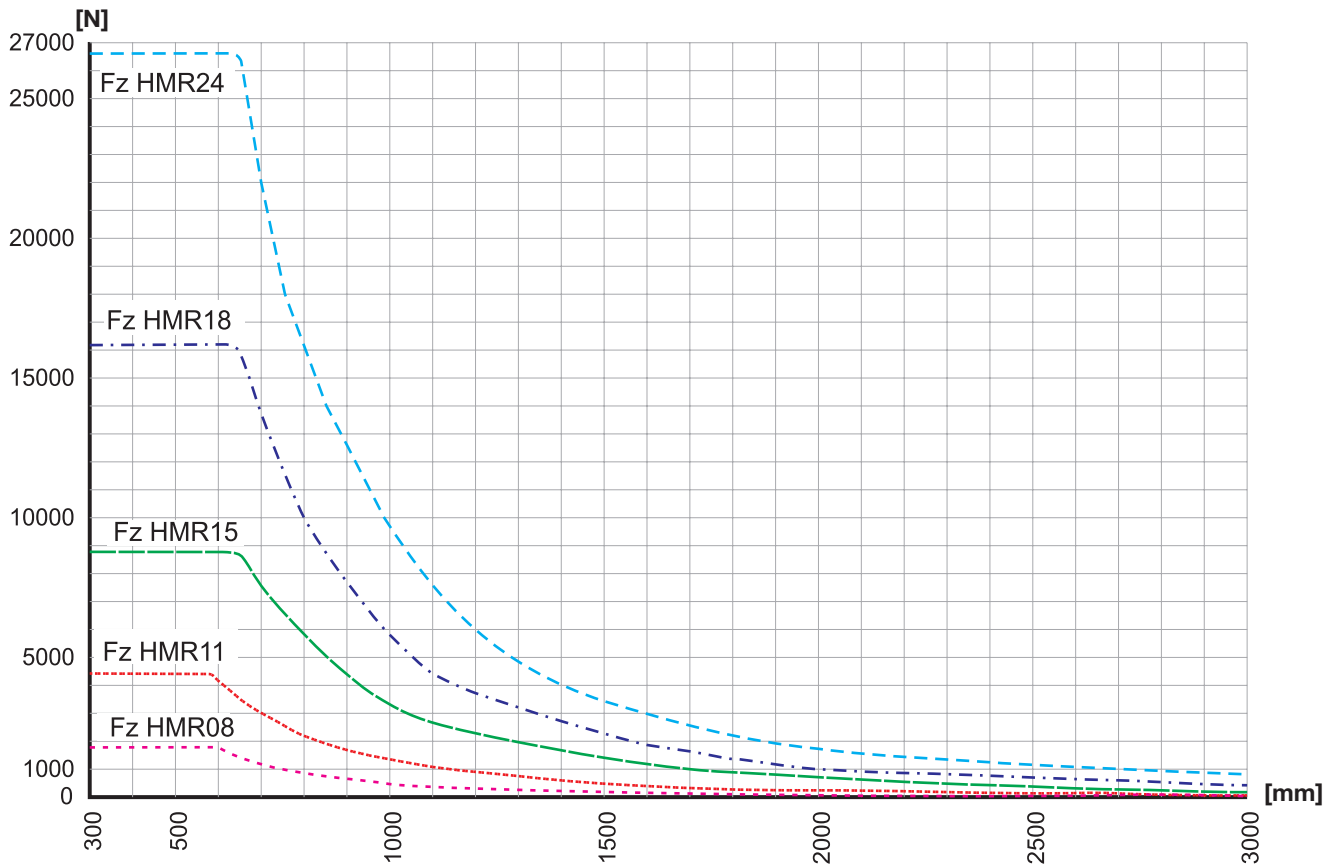

**Example  $F_z$  HMR 11:**

For a 2.800 N load the distance „D“ between supporting elements is 720 mm.  
Mounting accessories see „Accessories / T-Slot Mounting“

HMR series  
Profile version „reinforced“  
Sizes 85, 110, 150, 180, 240 mm

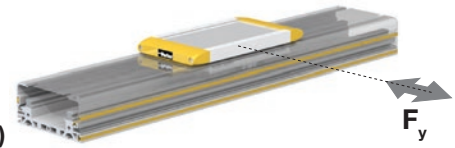

Max. admissible loads [N] and supporting distances [mm] (self-supporting)

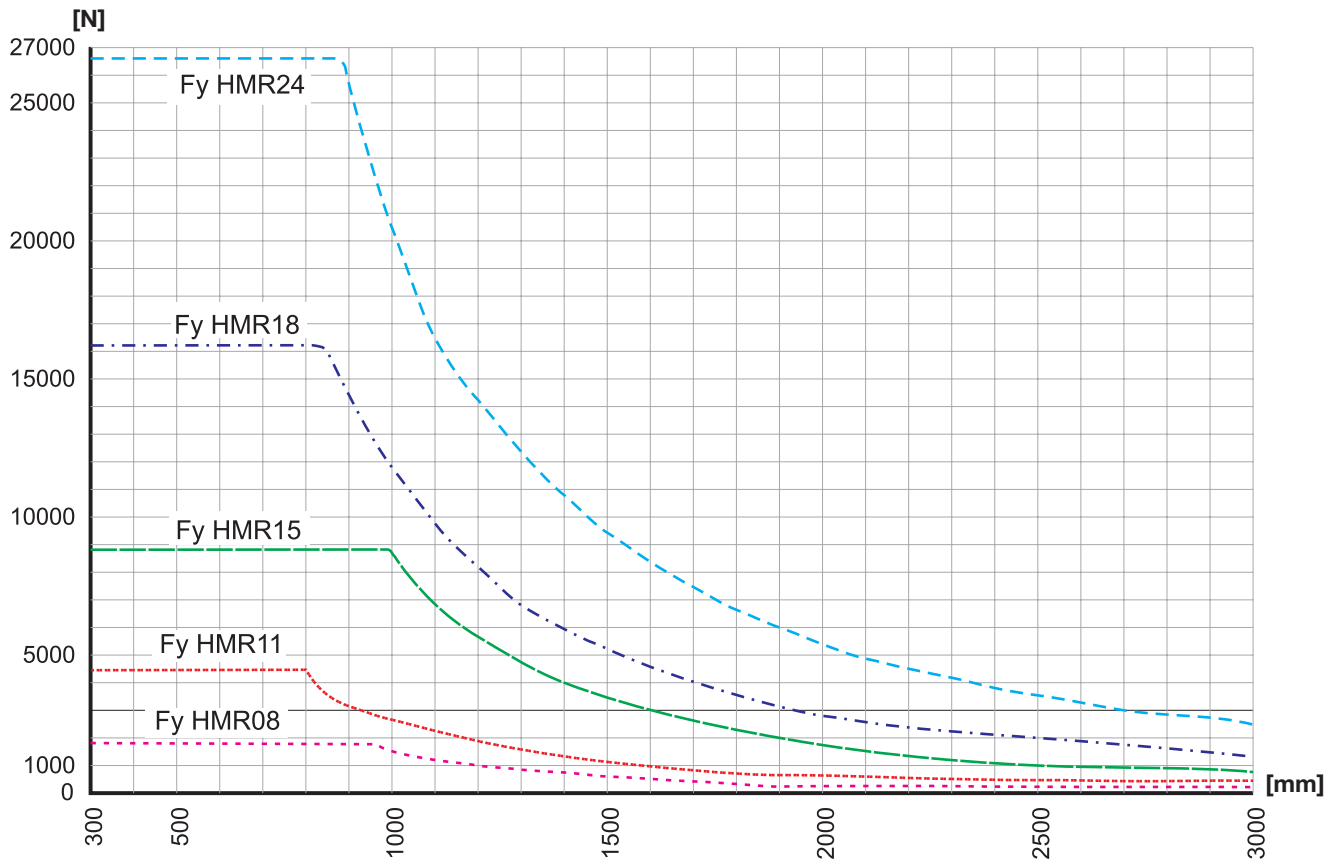

**Example F<sub>y</sub> HMR 11:**

For a 3.160 N load the distance „D“ between supporting elements is 900 mm.  
Mounting accessories see „Accessories / T-Slot Mounting“

# Precision Positioners

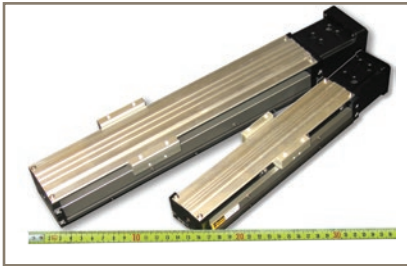

XE

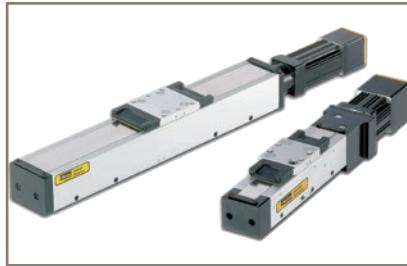

XR

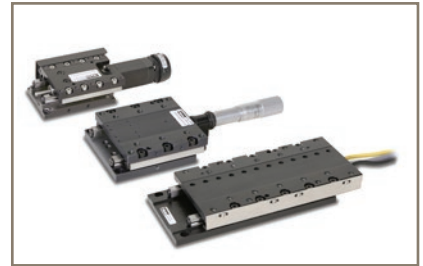

MX

# XE - Screw Driven Positioner

## XE Series Functions

### Features

- Integrated bearing
- Rigid steel body
- Significant force per dollar value
- Easily integrated into multi-axis systems
- Without adjustment
- Small package size



The 402/403XE series of positioners combines a rugged steel body construction with an integrated precision ballscrew and bearing guide to produce a highly accurate, cost-effective line of positioners ideal

for applications in the hard disk, semiconductor, medical, machine building and many other industries.

**Optional hard cover**  
Clear anodized cover provides protection from contamination falling into the positioner.

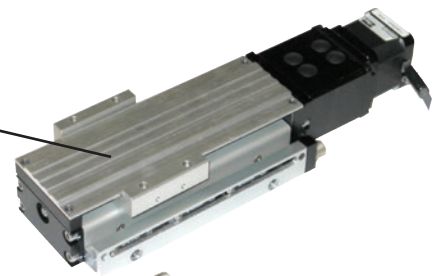

**Integrated precision screw and guide**  
The bearing provides a low profile, high accuracy, smooth motion, and robust adjustment free design over the life of the actuator.

**Precision ballscrew drive train**  
Provides smooth motion with high accuracy and high mechanical efficiency.

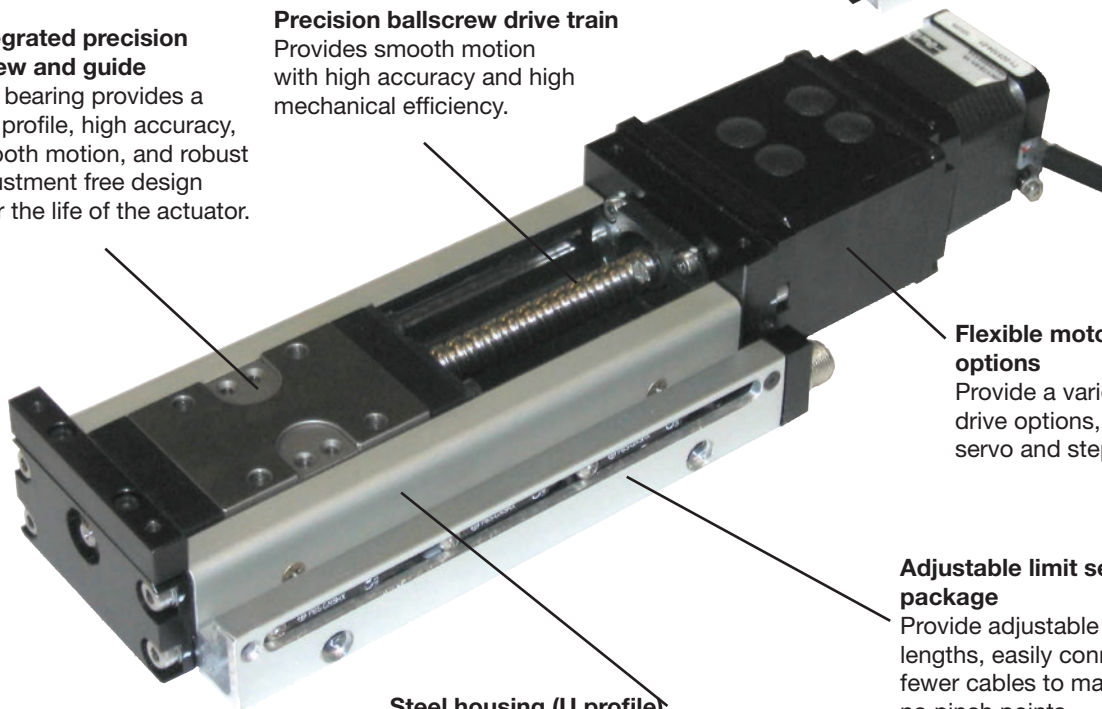

**Flexible motor mounting options**  
Provide a variety of motor drive options, including servo and stepper motors.

**Steel housing (U profile)**  
Provides structural rigidity for minimal deflection.

**Adjustable limit sensor package**  
Provide adjustable travel lengths, easily connected, fewer cables to manage, and no pinch points.

## XE Series Technical Data

### Common performance specifications

Technical data	Unit	402XE		403XE	
		2 mm lead	5 mm lead	5 mm lead	10 mm lead
Repeatability	[ $\mu\text{m}$ ]	$\pm 5$		$\pm 5$	
Flatness	[ $\mu\text{m}$ ]	15		see below	
Straight line accuracy	[ $\mu\text{m}$ ]	15		see below	
Breakaway torque	[Nm]	0.06		0.15	
Maximum input speed	[ $\text{s}^{-1}$ ]	90		see below	
Maximum normal load	[kg]	90		160	
Maximum inverted load	[kg]	90		160	
Static permissible pitch moment	[Nm]	46		101	
Static permissible roll moment	[Nm]	134		260	
Static permissible yaw moment	[Nm]	51		120	
Torsional pitch stiffness	[arcsec/Nm]	17.7		9.2	
Torsional yaw stiffness	[arcsec/Nm]	11.8		6.1	
Torsional roll stiffness	[arcsec/Nm]	5.9		5.9	
Drive screw diameter	[mm]	8		10	
Drive screw efficiency	[%]	90		90	
Linear bearing coefficient of friction		0.01		0.01	
Running torque	[Nm]	0.05		0.10	
Maximum axial load	[kg]	13	17	31	27
Moment of inertia X of guide rail	[ $\text{mm}^4$ ]	14 400		38 800	
Moment of inertia Y of guide rail	[ $\text{mm}^4$ ]	137 000		314 000	
Carriage mass	[kg]	0.26		0.3	
Maximum acceleration	[ $\text{m}/\text{s}^2$ ]	19.62		19.62	
Allowable duty cycle	[%]	100		100	

### 402XE Specifications

Technical data	Unit	T01 70 mm	T02 120 mm	T03 170 mm	T04 220 mm
<b>402XE with 2 mm lead</b>					
Accuracy	[ $\mu\text{m}$ ]	70	75	85	90
Input inertia	[ $10^{-6}\text{kgm}^2$ ]	0.615	0.772	0.929	1.09
Weight of total table	[kg]	1.19	1.40	1.60	1.81
<b>402XE with 5 mm lead</b>					
Accuracy	[ $\mu\text{m}$ ]	70	75	85	90
Input inertia	[ $10^{-6}\text{kgm}^2$ ]	0.741	0.898	1.06	1.21
Weight of total table	[kg]	1.19	1.40	1.60	1.81

### 403XE Specifications

Technical data	Unit	T01 55 mm	T02 105 mm	T03 205 mm	T04 305 mm	T05 405 mm	T06 505 mm	T07 605 mm	T08 655 mm
<b>403XE with 5 mm lead</b>									
Accuracy	[ $\mu\text{m}$ ]	70	80	90	95	100	110	120	n/a
Flatness	[ $\mu\text{m}$ ]	15	15	15	15	25	25	25	n/a
Straight line accuracy	[ $\mu\text{m}$ ]	15	15	15	15	25	25	25	n/a
Maximum input speed	[ $\text{s}^{-1}$ ]	80	80	80	80	80	80	60	n/a
Input inertia	[ $10^{-6}\text{kgm}^2$ ]	1.72	2.10	2.87	3.63	4.40	5.17	5.93	n/a
Weight of total table	[kg]	1.85	2.25	2.85	3.55	4.25	4.85	5.55	n/a
<b>403XE with 10 mm lead</b>									
Accuracy	[ $\mu\text{m}$ ]	70	80	90	95	100	110	120	130
Maximum input speed	[ $\text{s}^{-1}$ ]	80	80	80	80	80	80	60	42
Input inertia	[ $10^{-6}\text{kgm}^2$ ]	2.50	2.88	3.65	4.42	5.18	5.95	6.7	7.10
Weight of total table	[kg]	1.85	2.25	2.85	3.55	4.25	4.85	5.55	5.85

## 404XE Series Technical Data

### Common performance specifications

	Unit	404XE
<b>Bidirectional repeatability</b>		
T01 to T11 models	[µm]	±20
T12 to T15 models		±30
<b>Duty cycle</b>	[%]	100
<b>Max acceleration<sup>(1)</sup></b>	[m/s <sup>2</sup> ]	20
<b>Normal force<sup>(2)</sup></b>		
NL (short carriage)	[N]	601
VL (long carriage)		1202
<b>Axial force<sup>(2)</sup></b>		
5 mm lead	[N]	588
10 mm lead		686
20 mm lead		686
<b>Drive screw efficiency</b>	[%]	90
<b>Max. breakaway torque</b>	[Nm]	0.25
<b>Max running torque (rated @ 2 s<sup>-1</sup>)</b>	[Nm]	0.21
<b>Linear bearing – coefficient of friction</b>		0.01
<b>Ballscrew diameter</b>		
5 & 10 mm lead	[mm]	16
20 mm lead		15
<b>Carriage mass</b>		
NL (short carriage)	[kg]	0.215
VL (long carriage)		0.495

(1) Applies to units with VL carriage.

(2) Refer to life/load charts.

### Travel dependent characteristics

Code	Travel		Positional accuracy <sup>(3)(4)</sup>	Input inertia NL carriage units			Input inertia VL carriage units			Max. screw speed	Max. speed			Total weight of axis	
	[mm]		[µm]	[10 <sup>-5</sup> kgm <sup>2</sup> ]			[10 <sup>-5</sup> kgm <sup>2</sup> ]			[s <sup>-1</sup> ]	[m/s]			[kg]	
	NL	VL		5 mm	10 mm	20 mm	5 mm	10 mm	20 mm		5 mm	10 mm	20 mm	NL	VL
T01	25	–	42	0.81	–	–	–	–	–	72	0.36	0.73	1.50	1.42	1.70
T02	50	–	50	0.94	0.98	–	–	–	–	72	0.36	0.73	1.50	1.61	1.89
T03	100	33	58	1.19	1.23	1.12	1.21	1.30	1.4	72	0.36	0.73	1.50	1.95	2.23
T04	150	83	66	1.44	1.48	1.32	1.46	1.55	1.6	72	0.36	0.73	1.50	2.35	2.63
T05	200	133	74	1.69	1.73	1.51	1.71	1.80	1.79	72	0.36	0.73	1.50	2.59	2.87
T06	250	183	82	1.94	1.99	1.70	1.96	2.06	1.99	72	0.36	0.73	1.50	2.97	3.25
T07	300	233	90	2.20	2.24	1.90	2.21	2.31	2.18	72	0.36	0.73	1.50	3.34	3.62
T08	350	283	98	2.45	2.49	2.09	2.47	2.56	2.37	72	0.36	0.73	1.50	3.50	3.78
T09	400	333	106	2.70	2.74	2.29	2.72	2.81	2.57	72	0.36	0.73	1.50	3.83	4.11
T10	450	383	114	2.95	2.99	2.48	2.97	3.07	2.76	72	0.36	0.73	1.50	4.09	4.37
T11	500	433	122	3.21	3.25	2.67	3.22	3.32	2.96	72	0.36	0.73	1.50	4.22	4.50
T12	550	483	130	3.46	3.50	2.87	3.48	3.57	3.15	72	0.36	0.73	1.50	4.55	4.83
T13	600	533	138	3.71	3.75	3.06	3.73	3.82	3.34	69	0.34	0.68	1.32	4.87	5.15
T15	700	633	154	4.21	4.25	3.45	4.23	4.33	3.73	52	0.26	0.52	1.00	5.12	5.40

(3) Positioning accuracies refer only to direct motor mounting configurations, position specifications are based on conditions without load and do apply only to individual axes.

(4) Consult factory for specs with linear feedback.



# XR - Screw Driven Positioner

## XR Series Functions

- Pre-engineered package
- Performance matched components
- Environmental protection
- Laser certified precision

### Typical enhancements

- Limit/home position sensors
- Linear encoder
- Cleanroom prep
- Multi-axis brackets & adapters
- Selectable motor mounts
- Servo motors and drives
- Programmable controls
- Cable management system

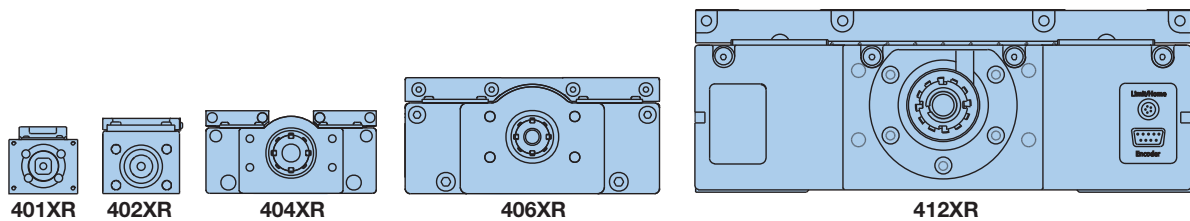

Style	Unit	401XR	402XR	404XR	406XR	412XR
Stroke	[mm]	300	600	600	2000	2000
Load	[kg]	50	100	170	630	1470
Acceleration	[m/s <sup>2</sup> ]	20	20	20	20	20

The „XR“ precision linear positioners family has achieved global recognition for consistent accuracy, reliable performance, high strength, and unmatched versatility. The XRs have excelled in industries such as life sciences, fiber optics and instrumentation, where the highest degree of precision is required. And yet, because of the rugged construction, strength, and sealed design, these units have been used extensively for industrial automation

applications (packaging, automotive, etc).

The XR family offers an unrivaled array of features and options which are easily matched to fit any application, from the very basic to the highly complex. Premier performance, modular compatibility, and quick delivery have made these tables the perfect building blocks for precision multi-axis systems.

## XR Series Technical Data

### 401XR and 402XR Technical Data

#### 401XR (41 mm wide profile)

#### 402XR series (58 mm wide profile)

The 401XR and 402XR Series positioners enhance the XR family of precision linear positioners, addressing applications which involve precise positioning of smaller payloads within a very small space envelope.

These ballscrew driven positioners were developed to address the needs of industries such as photonics, life sciences, semiconductor, and

instrumentation, where technology advancements dictate miniaturization of work envelopes.

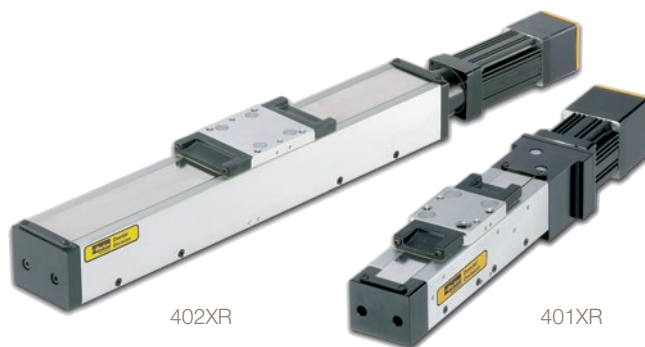

### Common characteristics

Style	Unit	Precision*		Standard	
		401XR	402XR	401XR	402XR
<b>Bidirectional repeatability</b>					
2 mm lead	[ $\mu\text{m}$ ]	$\pm 1.3$	-	$\pm 5$	-
5 or 10 mm lead		$\pm 1.3$	$\pm 1.3$	$\pm 12$	$\pm 12$
<b>Duty cycle</b>	[%]	100	100	100	100
<b>Maximum acceleration</b>	[ $\text{m/s}^2$ ]	20	20	20	20
<b>Normal force <sup>(1)</sup></b>	[N]	490	980	490	980
<b>Axial force <sup>(1)</sup></b>					
2 mm lead	[N]	54	-	54	-
5 or 10 mm lead		152	372	152	372
<b>Drive screw efficiency</b>	[%]	80	80	80	80
<b>Maximum breakaway torque</b>	[Nm]	0.03	0.086	0.03	0.086
<b>Maximum running torque <sup>(2)</sup></b>	[Nm]	0.028	0.08	0.028	0.08
<b>Linear bearing friction coefficient</b>	-	0.01	0.01	0.01	0.01
<b>Ballscrew diameter</b>					
2 mm lead	[mm]	6	-	6	-
5 or 10 mm lead		8	12	8	12
<b>Weight of carriage</b>	[kg]	0.045	0.11	0.045	0.11

\* Requires linear encoder option E3 or E4. (1) see life load charts. (2) Ratings established at a screw speed of 2 s<sup>-1</sup>.

### Travel dependent specifications

Travel [mm]	Positional accuracy*				Straightness & flatness		Input moment of inertia				Max screw speed		Weight	
	[ $\mu\text{m}$ ]				[ $\mu\text{m}$ ]		[ $10^{-7}\text{kgm}^2$ ]				[s <sup>-1</sup> ]		[kg]	
	401XR		402XR		401XR	402XR	401XR		402XR		401XR	402XR	401XR	402XR
	Precision	Standard	Precision	Standard			2 mm	10 mm	5 mm	10 mm				
50	10	20	-	-	20	-	0.6	-	-	-	100	-	1.0	-
100	10	20	10	20	20	20	0.9	-	12.0	-	100	90	1.2	2.3
150	12	20	12	20	20	20	1.1	-	15.0	-	100	90	1.3	2.6
200	16	30	16	30	25	25	-	4.7	20.0	-	100	90	1.5	2.8
300	18	40	18	40	25	25	-	5.2	-	25.0	100	90	1.7	3.2
400	-	-	21	40	-	30	-	-	-	29.0	-	95	-	3.8
600	-	-	25	50	-	30	-	-	-	39.0	-	50	-	4.8

\* Values established at 20 °C ambient temperature utilizing slope correction factor provided.

## 404XR Technical Data

### 404XR (95 mm wide profile)

The 404XR is a slim, compact positioning stage (47.3 x 95 mm) able to transport payloads up to 170 kg over a travel of 700 mm. Its fast and precise positioning properties are due to the extremely robust extruded profile, the ball bearings and the precision-ground rack-and-pinion drive.

With its low profile design the 404XR is ideal for height restricted applications, and its lightweight construction makes it well suited

as secondary axes on multi-axis systems.

These units offer a wide array of easily adapted options and accessories which permit easy configuration to specific requirements.

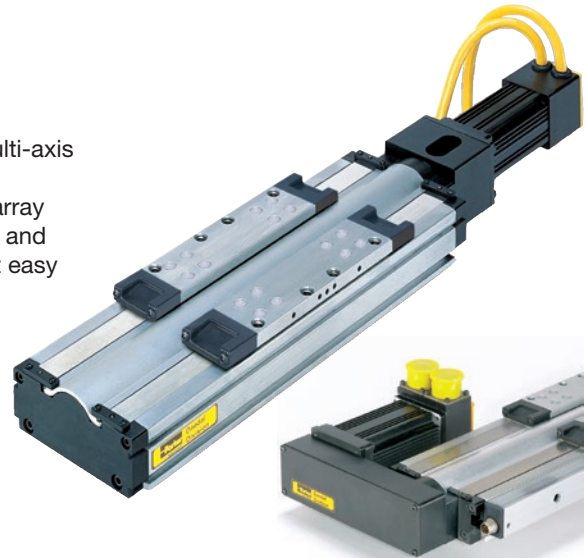

Parallel Motor Mount  
(with limit/home sensor pack option)

### Common characteristics

Type 404XR	Unit	Precision	Standard
<b>Bidirectional repeatability</b> <sup>(5)</sup>	[ $\mu\text{m}$ ]	$\pm 1.3$	$\pm 3$
<b>Duty cycle</b>	[%]	100	100
Ballscrew			
<b>Maximum acceleration</b>	[ $\text{m/s}^2$ ]	20	20
<b>Normal force</b> <sup>(1)</sup>	[N]	1667	1667
<b>Axial force</b> <sup>(2)</sup>	[N]	882	882
Ballscrew			
<b>Drive screw efficiency</b>	[%]	90	90
Ballscrew			
<b>Maximum breakaway torque</b>	[Nm]	0.13	0.18
<b>Maximum running torque</b> <sup>(3)</sup>	[Nm]	0.11	0.17
<b>Linear bearing friction coefficient</b>	-	0.01	0.01
<b>Ballscrew diameter</b>	[mm]	16	16
<b>Weight of carriage</b>	[kg]	0.70	0.70

(1) see life load charts.

(2) Axial load for parallel mount is limited by a maximum input torque of 25 Nm.

(3) Ratings established at a screw speed of 2  $\text{s}^{-1}$ .

(4) Positional accuracy applies to in-line motor configurations only. Contact factory for parallel motor specifications.

(5) Consult factory for specifications with linear encoder.

(6) Consult factory for higher screw speeds.

### Travel dependent specifications

Travel [mm]	Positional accuracy <sup>(4) (5)*</sup> [ $\mu\text{m}$ ]		Straightness & flatness [ $\mu\text{m}$ ]	Input moment of inertia [ $10^{-5}\text{kgm}^2$ ]			Max screw speed <sup>(6)</sup> [ $\text{s}^{-1}$ ]	Weight [kg]
	Precision	Standard		5 mm	10 mm	20 mm		
50	8	12	6	1.68	1.81	2.34	60	2.8
100	8	12	6	1.93	2.07	2.60	60	3.0
150	10	14	9	2.19	2.32	2.85	60	3.3
200	12	20	10	2.44	2.57	3.11	60	3.6
250	12	22	12	2.69	2.83	3.36	60	3.9
300	14	24	13	2.95	3.08	3.61	60	4.2
350	14	26	15	3.20	3.33	3.87	60	4.5
400	16	26	16	3.46	3.59	4.12	60	4.8
450	19	28	18	3.71	3.84	4.37	60	5.1
500	21	34	19	3.96	4.10	4.63	60	5.4
550	23	36	21	4.22	4.35	4.88	60	5.7
600	25	40	22	4.47	4.60	5.14	54	6.0

\* Values established at 20 °C ambient temperature utilizing slope correction factor provided.

## 406XR Technical Data

### 406XR (150 mm wide profile)

The 406XR can position high loads (up to 6.2 kN) over distances up to two meters. Because of its size and strength (270 Nm moment load capacity) this table is ideal as the base unit in a multi-axis system. From high resolution to high throughput, selectable ballscrew leads (5, 10, 20, 25 mm) make the desired resolution/

velocity ratio easy to achieve, and stainless steel seal strips alleviate environmental concerns.



Parallel Motor Mount  
(with limit/home sensor pack option)

### Common characteristics

Type 406XR	Unit	Precision	Standard
<b>Bidirectional repeatability</b> <sup>(5)</sup>	[ $\mu\text{m}$ ]	$\pm 1.3$	$\pm 3$
<b>Duty cycle</b>	[%]	100	100
<b>Maximum acceleration</b>	[ $\text{m/s}^2$ ]	20	20
<b>Normal force</b> <sup>(1)</sup>	[N]	6178	6178
<b>Axial force</b> <sup>(2)</sup>			
0 to 600 mm travel	[N]	882	882
700 to 2000 mm travel		-	1961
<b>Drive screw efficiency</b>	[%]	90	90
<b>Maximum breakaway torque</b>			
0 to 600 mm travel	[Nm]	0.13 (18)	0.18
700 to 2000 mm travel		-	0.39
<b>Maximum running torque</b> <sup>(3)</sup>			
0 to 600 mm travel	[Nm]	0.11	0.17
700 to 2000 mm travel		-	0.34
<b>Linear bearing friction coefficient</b>	-	0.01	0.01
<b>Ballscrew diameter</b>			
0 to 600 mm travel	[mm]	16	16
700 to 2000 mm travel		-	25
<b>Weight of carriage</b>	[kg]	2.7	2.7

- (1) see life load charts.  
 (2) Axial load for parallel mount is limited to: 63.5 kg for the 5, 10 and 20 mm lead drives: 104 kg for 25 mm lead drives  
 (3) Ratings established at a screw speed of  $2 \text{ s}^{-1}$ .  
 (4) Positional accuracy applies to in-line motor configurations only. Contact factory for parallel motor specifications.  
 (5) Consult factory for specifications with linear encoder.  
 (6) Consult factory for higher screw speeds.

### Travel dependent specifications

Travel [mm]	Positional accuracy <sup>(4) (5)*</sup> [ $\mu\text{m}$ ]		Straightness & flatness [ $\mu\text{m}$ ]	Input moment of inertia [ $10^{-5} \text{ kgm}^2$ ]				Max screw speed <sup>(6)</sup> [ $\text{s}^{-1}$ ]	Weight [kg]
	Präzision	Standard		5 mm	10 mm	20 mm	25 mm		
100	8	12	6	3.34	3.85	5.90	-	60	8.7
200	12	20	10	3.92	4.43	6.48	-	60	10.0
300	14	24	13	4.50	5.01	7.06	-	60	11.3
400	16	26	16	5.08	5.59	7.64	-	60	12.6
500	21	34	19	5.65	6.17	8.22	-	55	13.9
600	25	40	22	6.23	6.75	8.80	-	44	15.2
700	-	92	25	36.51	37.02	-	40.61	47	19.2
800	-	94	29	39.96	40.47	-	44.07	47	20.7
900	-	103	32	43.41	43.93	-	47.52	47	22.2
1000	-	105	35	46.87	47.38	-	50.97	47	23.7
1250	-	118	42	55.50	56.01	-	59.61	35	27.6
1500	-	134	50	64.14	64.65	-	68.24	26	31.4
1750	-	154	57	72.77	73.28	-	76.88	20	35.2
2000	-	159	65	81.40	81.92	-	85.51	16	39.1

\* Values established at 20 °C ambient temperature utilizing slope correction factor provided.

## 412XR Technical Data

### 412XR (285 mm wide profile)

The 412XR is a rugged heavy duty linear table (285 mm x 105 mm profile) that enables massive loads (up to 14.4 kN) to be precisely positioned over distances up to two meters. The lubricating hole for easy maintenance is a standard feature of the carriage. The easy to mount adaptor plate (Art. No. 100-6784-01) for simple X-Y configuration is available as an accessory.

An unrivaled array of options combined with mounting compatibility with the smaller XR tables makes the 412XR ideal as the base unit for multi-axis positioning of heavier payloads.



### Common Characteristics

Type 412XR	Unit	Standard	
Screw Lead	[mm]	5, 10, 25	32
Bidirectional repeatability <sup>(4)</sup>	[µm]	±5	±5
Duty cycle	[%]	100	100
Maximum acceleration	[m/s <sup>2</sup> ]	20	20
Normal force <sup>(1)</sup>	[kN]	14.4	14.4
Axial force	[kN]	1.96	4.51
Drive screw efficiency	[%]	90	80
Maximum breakaway torque	[Nm]	0.61	0.76
Maximum running torque <sup>(2)</sup>	[Nm]	0.55	0.69
Linear bearing friction coefficient	-	0.01	0.01
Ballscrew diameter	[mm]	25	32
Weight of carriage	[kg]	12	13

- (1) See life load charts.
- (2) Ratings established at a screw speed of 2 s<sup>-1</sup>.
- (3) Positional accuracy applies to in-line motor configurations only. Contact factory for parallel motor specifications.
- (4) Consult factory for specifications with linear encoder.
- (5) Consult factory for higher screw speeds.

### Travel Dependent Specifications

Travel [mm]	Positional-accuracy <sup>(3 (4)*)</sup> [µm]	Straightness & flatness [µm]	Input moment of inertia [10 <sup>-5</sup> kgm <sup>2</sup> ]				Max screw speed <sup>(5)</sup> [s <sup>-1</sup> ]		Weight [kg]	
			5 mm	10 mm	25 mm	32 mm	5, 10, 25 mm	32 mm	5, 10, 25 mm	32 mm
150	64	9	27.20	29.45	46.76	98.20	47	42	39.6	41.5
250	66	12	30.21	32.46	49.78	106.28	47	42	42.9	45.0
350	71	15	33.23	35.48	52.79	114.37	47	42	46.2	48.5
650	91	24	42.27	44.52	61.83	138.63	47	42	56.1	59.0
800	94	29	46.79	49.04	66.35	150.76	47	42	61.0	64.2
1000	105	35	52.81	55.06	72.37	166.94	45	42	67.6	71.2
1250	118	42	58.84	61.09	78.40	183.11	34	41	74.2	78.2
1500	134	50	67.87	70.12	87.44	207.38	24	31	84.1	88.7
1750	154	57	75.41	77.66	94.97	227.59	18	24	92.4	97.5
2000	159	65	82.94	85.19	102.50	247.81	15	19	100.6	106.2

\* Values established at 20 °C ambient temperature utilizing slope correction factor provided.

## MX - Miniature Positioners

### Description

Life science applications are a good example of how miniaturization has driven the need for smaller and more efficient positioners. Parker's MX series miniature positioner, the smallest positioner in the industry, is loaded with high-performance features for both rapid travel and precise positioning of lighter loads in small work envelopes.

Designed for today's 24/7 production demands, the MX series has redefined "high-throughput automation" in the world of miniature positioners

### Typical areas of application

- Fiber optics
- Photonics
- Electronics and biomedical processes

### Features

- Low profile miniature size
- Different technologies available:
  - Ballscrew and leadscrew driven stages: MX45S, MX80S
  - Linear servo motor driven stages: MX80L
  - Free travel and micrometer driven stages: MX80M
- Cross roller bearing (zero cage creep option)
- Optional encoder
- Optional digital limit/home sensors
- Optional cleanroom and low ESD preparation
- Multi-axis platform

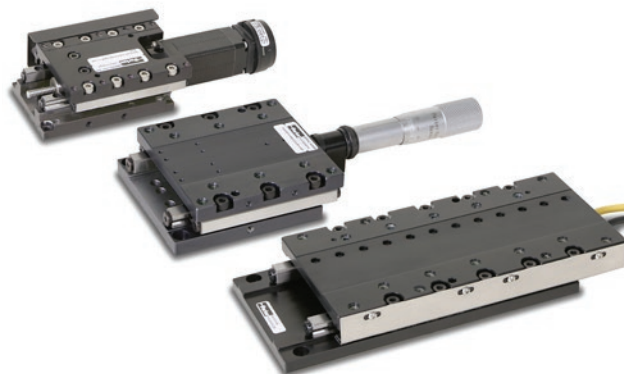

### Technical Characteristics - Overview

	Type: Miniature Positioners			
	MX45S	MX80S	MX80L	MX80M
<b>Technology</b>	screw driven		linear motor driven	manual driven
<b>Frame size height/width [mm]</b>	25x45 mm	35x80 mm	25x80 mm	25x80 mm
<b>Travel [mm]</b>	5, 15, 25	25, 50, 100, 150	25, 50, 100, 150, 200	25, 50
<b>Max. Speed [mm/s]</b>	20...2000			
<b>Nominal Load [kg]</b>	7	8	8	20
<b>Repeatability [µm]</b>	±1... ±8	±1.5... ±10	±0.4... ±10	-



## Technical Characteristics MX45S

		Unit	MX45S Leadscrew Drive (Standard)			MX45S Ballscrew Drive (Precision)		
			T01	T02	T03	T01	T02	T03
<b>Travel</b> <sup>(1)</sup>		[mm]	5	15	25	5	15	25
<b>Nominal load</b>		[kg]	5	5	7	5	5	7
<b>Thrust Load</b>		[N]	40			40		
<b>Maximum velocity</b> <sup>(2)</sup>	0.5 mm lead	[mm/s]	10			-		
	1.0 mm lead		20			30		
<b>Acceleration/deceleration</b>		[m/s <sup>2</sup> ]	20			20		
<b>Running torque</b>		[Nm]	0.011			0.011		
<b>Duty cycle</b>		[%]	50			100		
<b>Straightness &amp; flatness</b> <sup>(3)</sup>		[µm]	3	5	8	3	5	8
<b>Positional accuracy</b> <sup>(4)</sup>	with 2000 count rotary encoder	[µm]	10	18	30	8	12	15
	with 1 or 0.1 µm linear encoder		6	10	12	6	10	12
<b>Bidirectional repeatability</b> <sup>(4), (5)</sup>	with 2000 count rotary encoder	[µm]	±8			±3		
	with 1 µm linear encoder		±4			±2		
	with 0.1 µm linear encoder		±2			±1		
<b>Input inertia (without motor)</b>	0.5 mm lead	[10 <sup>-8</sup> kgm <sup>2</sup> ]	2.37	2.76	3.14	-	-	-
	1.0 mm lead		2.58	2.96	3.35	1.41	1.6	1.79
<b>Screw speed (max)</b>		[min <sup>-1</sup> ]	1200			1800		
<b>Screw diameter</b>		[mm]	4.7			4.0		
<b>Screw efficiency</b>	0.5 mm lead	[%]	30			-		
	1.0 mm lead		47			90		
<b>Bearing friction coefficient</b>		-	0.003			0.003		
<b>Unit weight</b>	Stage only	[kg]	0.177	0.200	0.238	0.182	0.205	0.243
	Carriage Only		0.070	0.082	0.100	0.073	0.084	0.104
<b>Additional mass of motors&amp;options</b>	NEMA 8 stepper <sup>(6)</sup>	[kg]	0.095			0.095		
	Linear encoder option <sup>(7)</sup>		0.016			0.016		
	Limit option sensor board <sup>(7)</sup>		0.005			0.005		

### Notes:

- (1) Travel is in the direction of the motor mount only.
- (2) See speed/force curve for performance with Parker motor.
- (3) Measured at the carriage center, 35 mm above the mounting surface @20 °C with no load. Unit bolted to granite surface, flat within 1 µm/300 mm.
- (4) Total accuracy and bi-directional repeatability over full travel (peak to peak) (with 0.5 or 1 mm leadscrew).
- (5) Repeatability valid with NEMA 8 stepper motor and encoder noted.
- (6) Includes rotary encoder (part of base)
- (7) Part of base



## Technical Characteristics MX80S

		Unit	MX80S Leadscrew Drive (Standard)				MX80S Ballscrew Drive (Precision)			
			T01	T02	T03	T04	T01	T02	T03	T04
<b>Travel</b>		[mm]	25	50	100	150	25	50	100	150
<b>Nominal load</b>		[kg]	8	8	8	8	8	8	8	8
<b>Axial thrust force</b>		[N]	44	44	44	44	123	123	123	123
<b>Breakaway torque</b>		[Nm]	0.021	0.021	0.021	0.021	0.050	0.050	0.050	0.050
<b>Running torque</b>	1.0 mm lead	[Nm]	0.028	0.028	0.035	0.035	-	-	-	-
	2.0 mm lead		0.028	0.028	0.035	0.035	0.085	0.085	0.085	0.085
	10.0 mm lead		0.021	0.021	0.021	0.028	-	-	-	-
<b>Inertia (without motor and coupling)</b>	1.0 mm lead	[10 <sup>-7</sup> kgm <sup>2</sup> ]	1.47	1.47	2.42	3.06	-	-	-	-
	2.0 mm lead		1.62	1.62	2.68	3.42	4.19	4.19	6.08	7.68
	10.0 mm lead		6.34	6.34	11.30	14.90	-	-	-	-
<b>Screw speed (max)</b>		[min <sup>-1</sup> ]	1200	1200	1200	1200	3000	3000	3000	3000
<b>Screw diameter</b>		[mm]	6.35	6.35	6.35	6.35	8.00	8.00	8.00	8.00
<b>Maximum speed</b>	1.0 mm lead	[mm/s]	20	20	20	20	-	-	-	-
	2.0 mm lead		40	40	40	40	100	100	100	100
	10.0 mm lead		200	200	200	200	-	-	-	-
<b>Bidirectional repeatability*</b>	1.0 mm lead	[μm]	±5.0	±5.0	±5.0	±5.0	-	-	-	-
	2.0 mm lead		±5.0	±5.0	±5.0	±5.0	±1.5	±1.5	±1.5	±1.5
	10.0 mm lead		±10.0	±10.0	±10.0	±10.0	-	-	-	-
<b>Positional accuracy*</b>	1.0 mm lead	[μm]	30	45	75	100	-	-	-	-
	2.0 mm lead		30	45	75	100	10	15	18	20
	10.0 mm lead		35	50	80	105	-	-	-	-
<b>Straightness &amp; flatness</b>		[μm]	8	12	16	20	8	12	16	20
<b>Screw efficiency</b>	1.0 mm lead	[%]	40	40	40	40	-	-	-	-
	2.0 mm lead		59	59	59	59	90	90	90	90
	10.0 mm lead		78	78	78	78	-	-	-	-
<b>Bearing friction coefficient</b>		-	0.003	0.003	0.003	0.003	0.003	0.003	0.003	0.003
<b>Duty cycle</b>		[%]	50	50	50	50	100	100	100	100
<b>Unit weight</b>	Table only with 2-stack stepper	[kg]	0.597	0.597	1.003	1.268	0.694	0.694	1.114	1.392
			0.748	0.748	1.154	1.419	0.845	0.845	1.265	1.513
<b>Carriage weight (unloaded)</b>		[kg]	0.194	0.194	0.353	0.471	0.291	0.291	0.464	0.595

**\* Notes: MX80SS (leadscrew drive)**

- (1) Measured at the carriage center, 35 mm above the mounting surface @ 20 °C with no load. Unit bolted to granite surface, flat to within 1 μm/300 mm.
- (2) Total accuracy and bi-directional repeatability over full travel (peak to peak).

**\* Notes: MX80S (ballscrew drive)**

- (1) Measured at the carriage center, 35 mm above the mounting surface @ 20 °C with no load. Unit bolted to granite surface, flat to within 1 μm/300 mm.
- (2) Total accuracy and bi-directional repeatability over full travel (peak to peak).
- (3) Repeatability valid with M21 servo motor.

## Technical Characteristics MX80L

		Unit	MX80L Precision Grade				MX80L Standard Grade				
			T01	T02	T03	T04	T01	T02	T03	T04	T05
<b>Travel</b>		[mm]	25	50	100	150	25	50	100	150	200
<b>Continuous force</b>		[N]	4	4	8	8	4	4	8	8	8
<b>Peak force</b>		[N]	12	12	24	24	12	12	24	24	24
<b>Continuous current</b>		[A <sub>rms</sub> ]	0.8	0.8	1.6	1.6	0.8	0.8	1.6	1.6	1.6
<b>Peak current**</b>		[A]	2.4	2.4	4.8	4.8	2.4	2.4	4.8	4.8	4.8
<b>Force constant</b>		[N/A <sub>rms</sub> ]	5.51	5.51	5.51	5.51	5.51	5.51	5.51	5.51	5.51
<b>Nominal load</b>		[kg]	8	8	8	8	8	8	8	8	8
<b>Max. speed</b> Encoder resolution:	5.0 µm	[mm/s]	1100	1500	2000	2000	1100	1500	2000	2000	2000
	1.0 µm		1100	1500	2000	2000	1100	1500	2000	2000	2000
	0.5 µm		1100	1500	1500	1500	1100	1500	1500	1500	1500
	0.1 µm		300	300	300	300	300	300	300	300	300
	0.02 µm		60	60	60	60	60	60	60	60	60
	0.01 µm		30	30	30	30	30	30	30	30	30
	Sine Cosine		1100	1500	2000	2000	1100	1500	2000	2000	2000
<b>Max. acceleration</b>		[m/s <sup>2</sup> ]	40	40	40	30	50	50	50	40	30
<b>Bidirectional repeatability*</b> Encoder resolution:	5.0 µm	[µm]	±10.0	±10.0	±10.0	±10.0	±10.0	±10.0	±10.0	±10.0	±10.0
	1.0 µm		±2.0	±2.0	±2.0	±2.0	±2.0	±2.0	±2.0	±2.0	±2.0
	0.5 µm		±1.0	±1.0	±1.0	±1.0	±1.0	±1.0	±1.0	±1.0	±1.0
	0.1 µm		±0.5	±0.5	±0.5	±0.5	±0.5	±0.5	±0.5	±0.5	±0.7
	0.02 µm		±0.4	±0.4	±0.4	±0.4	±0.4	±0.4	±0.4	±0.4	±0.5
	0.01 µm		±0.4	±0.4	±0.4	±0.4	±0.4	±0.4	±0.4	±0.4	±0.5
	Sine Cosine		±0.4	±0.4	±0.4	±0.4	±0.4	±0.4	±0.4	±0.4	±0.5
<b>Positional accuracy*</b> Encoder resolution:	5.0 µm	[µm]	13	14	15	15	25	30	35	35	35
	1.0 µm		5	6	7	7	15	20	25	25	25
	0.5 µm		4	5	6	6	12	15	20	20	20
	0.1 µm		3	4	5	5	12	15	20	20	20
	0.02 µm		3	4	5	5	12	15	20	20	20
	0.01 µm		3	4	5	5	12	15	20	20	20
	Sine Cosine		3	4	5	5	12	15	20	20	20
<b>Straightness &amp; flatness</b>		[µm]	4	4	5	6	6	6	10	12	14
<b>Duty cycle</b>		[%]	100	100	100	100	100	100	100	100	100
<b>Unit weight</b>		[kg]	0.590	0.590	1.027	1.345	0.475	0.475	0.875	1.125	1.370
<b>Carriage weight (unloaded)</b>		[kg]	0.282	0.282	0.509	0.676	0.213	0.213	0.405	0.537	0.695

\*\* based on a winding temperature of up to 60 °C for a period of T01, T02: 1.2 s T03, T04, T05: 5 s

**\* Notes MX80L (Precision):**

- (1) Measured at the carriage center, 35 mm above the mounting surface @ 20 °C with no load. Unit bolted to granite surface, flat to within 1 µm/300 mm.
- (2) Total accuracy and bi-directional repeatability over full travel (peak to peak).
- (3) Precision grade with slope correction value. Consult factory if better accuracy is required.

**\* Notes MX80L (Standard):**

- (1) Total accuracy and bi-directional repeatability over full travel (peak to peak).

# MX80M - Free Travel and Micrometer Driven Stages

## Description

The MX80M stages are offered as free travel or micrometer driven units with 25 mm or 50 mm travel. They include innovative tooling features to make mounting and precision alignment quicker and easier. A hardened steel master reference surface is provided along the side of the stage to allow fixturing or other tooling elements to be precisely aligned with the actual travel path. Dowel pin holes are provided on the carriage top for repeatable mounting or tooling. Also available are custom features such as a steel body design, vacuum prepped units, and anti cage creep bearings for high dynamic applications up to 150 mm travel.

## Features

- Precision cross roller bearings
- Clean room preparation (option)
- Low ESD coating (option)
- Dowel holes in top & base
- Interchangeable mounting with motorized MX80 models
- Positive position lock



## Technical Characteristics MX80M

	Unit	MX80M free travel		MX80M micrometer driven	
		T01	T02	T01	T02
<b>Travel</b>	[mm]	25	50	25	50
<b>Nominal load</b>	[kg]	20	20	20	20
<b>Axial force <sup>(1)</sup></b>					
F <sub>a</sub>	[N]	-	-	44.1	44.1
F <sub>b</sub>		-	-	5.9	9.8
<b>Straight line accuracy (per 25 mm travel)</b>	[µm]	2	2	2	2
<b>Micrometer resolution</b>					
0.001 in	-	-	-	Yes	Yes
0.01 mm		-	-	Yes	Yes
<b>Digital micrometer</b>					
0.00005 in	-	-	-	Yes	Yes
0.001 mm		-	-	Yes	Yes

<sup>(1)</sup> F<sub>a</sub> (Force acting against micrometer)  
 F<sub>b</sub> (Force acting against spring)



# Parker's Motion & Control Technologies

At Parker, we're guided by a relentless drive to help our customers become more productive and achieve higher levels of profitability by engineering the best systems for their requirements. It means looking at customer applications from many angles to find new ways to create value. Whatever the motion and control technology need, Parker has the experience, breadth of product and global reach to consistently deliver. No company knows more about motion and control technology than Parker. For further info call 00800 27 27 5374



## Aerospace

### Key Markets

Aftermarket services  
Commercial transports  
Engines  
General & business aviation  
Helicopters  
Launch vehicles  
Military aircraft  
Missiles  
Power generation  
Regional transports  
Unmanned aerial vehicles

### Key Products

Control systems & actuation products  
Engine systems & components  
Fluid conveyance systems & components  
Fluid metering, delivery & atomization devices  
Fuel systems & components  
Fuel tank inerting systems  
Hydraulic systems & components  
Thermal management  
Wheels & brakes



## Climate Control

### Key Markets

Agriculture  
Air conditioning  
Construction Machinery  
Food & beverage  
Industrial machinery  
Life sciences  
Oil & gas  
Precision cooling  
Process  
Refrigeration  
Transportation

### Key Products

Accumulators  
Advanced actuators  
CO<sub>2</sub> controls  
Electronic controllers  
Filter driers  
Hand shut-off valves  
Heat exchangers  
Hose & fittings  
Pressure regulating valves  
Refrigerant distributors  
Safety relief valves  
Smart pumps  
Solenoid valves  
Thermostatic expansion valves



## Electromechanical

### Key Markets

Aerospace  
Factory automation  
Life science & medical  
Machine tools  
Packaging machinery  
Paper machinery  
Plastics machinery & converting  
Primary metals  
Semiconductor & electronics  
Textile  
Wire & cable

### Key Products

AC/DC drives & systems  
Electric actuators, gantry robots & slides  
Electrohydraulic actuation systems  
Electromechanical actuation systems  
Human machine interface  
Linear motors  
Stepper motors, servo motors, drives & controls  
Structural extrusions



## Filtration

### Key Markets

Aerospace  
Food & beverage  
Industrial plant & equipment  
Life sciences  
Marine  
Mobile equipment  
Oil & gas  
Power generation & renewable energy  
Process  
Transportation  
Water Purification

### Key Products

Analytical gas generators  
Compressed air filters & dryers  
Engine air, coolant, fuel & oil filtration systems  
Fluid condition monitoring systems  
Hydraulic & lubrication filters  
Hydrogen, nitrogen & zero air generators  
Instrumentation filters  
Membrane & fiber filters  
Microfiltration  
Sterile air filtration  
Water desalination & purification filters & systems



## Fluid & Gas Handling

### Key Markets

Aerial lift  
Agriculture  
Bulk chemical handling  
Construction machinery  
Food & beverage  
Fuel & gas delivery  
Industrial machinery  
Life sciences  
Marine  
Mining  
Mobile  
Oil & gas  
Renewable energy  
Transportation

### Key Products

Check valves  
Connectors for low pressure fluid conveyance  
Deep sea umbilicals  
Diagnostic equipment  
Hose couplings  
Industrial hose  
Mooring systems & power cables  
PTFE hose & tubing  
Quick couplings  
Rubber & thermoplastic hose  
Tube fittings & adapters  
Tubing & plastic fittings



## Hydraulics

### Key Markets

Aerial lift  
Agriculture  
Alternative energy  
Construction machinery  
Forestry  
Industrial machinery  
Machine tools  
Marine  
Material handling  
Mining  
Oil & gas  
Power generation  
Refuse vehicles  
Renewable energy  
Truck hydraulics  
Turf equipment

### Key Products

Accumulators  
Cartridge valves  
Electrohydraulic actuators  
Human machine interfaces  
Hybrid drives  
Hydraulic cylinders  
Hydraulic motors & pumps  
Hydraulic systems  
Hydraulic valves & controls  
Hydrostatic steering  
Integrated hydraulic circuits  
Power take-offs  
Power units  
Rotary actuators  
Sensors



## Pneumatics

### Key Markets

Aerospace  
Conveyor & material handling  
Factory automation  
Life science & medical  
Machine tools  
Packaging machinery  
Transportation & automotive

### Key Products

Air preparation  
Brass fittings & valves  
Manifolds  
Pneumatic accessories  
Pneumatic actuators & grippers  
Pneumatic valves & controls  
Quick disconnects  
Rotary actuators  
Rubber & thermoplastic hose & couplings  
Structural extrusions  
Thermoplastic tubing & fittings  
Vacuum generators, cups & sensors



## Process Control

### Key Markets

Alternative fuels  
Biopharmaceuticals  
Chemical & refining  
Food & beverage  
Marine & shipbuilding  
Medical & dental  
Microelectronics  
Nuclear Power  
Offshore oil exploration  
Oil & gas  
Pharmaceuticals  
Power generation  
Pulp & paper  
Steel  
Water/wastewater

### Key Products

Analytical Instruments  
Analytical sample conditioning products & systems  
Chemical injection fittings & valves  
Fluoropolymer chemical delivery fittings, valves & pumps  
High purity gas delivery fittings, valves, regulators & digital flow controllers  
Industrial mass flow meters/controllers  
Permanent no-weld tube fittings  
Precision industrial regulators & flow controllers  
Process control double block & bleeds  
Process control fittings, valves, regulators & manifold valves



## Sealing & Shielding

### Key Markets

Aerospace  
Chemical processing  
Consumer  
Fluid power  
General industrial  
Information technology  
Life sciences  
Microelectronics  
Military  
Oil & gas  
Power generation  
Renewable energy  
Telecommunications  
Transportation

### Key Products

Dynamic seals  
Elastomeric o-rings  
Electro-medical instrument design & assembly  
EMI shielding  
Extruded & precision-cut, fabricated elastomeric seals  
High temperature metal seals  
Homogeneous & inserted elastomeric shapes  
Medical device fabrication & assembly  
Metal & plastic retained composite seals  
Shielded optical windows  
Silicone tubing & extrusions  
Thermal management  
Vibration dampening

# Parker Worldwide

## Europe, Middle East, Africa

**AE – United Arab Emirates, Dubai**  
Tel: +971 4 8127100  
parker.me@parker.com

**AT – Austria, Wiener Neustadt**  
Tel: +43 (0)2622 23501-0  
parker.austria@parker.com

**AT – Eastern Europe, Wiener Neustadt**  
Tel: +43 (0)2622 23501 900  
parker.easteurope@parker.com

**AZ – Azerbaijan, Baku**  
Tel: +994 50 2233 458  
parker.azerbaijan@parker.com

**BE/LU – Belgium, Nivelles**  
Tel: +32 (0)67 280 900  
parker.belgium@parker.com

**BG – Bulgaria, Sofia**  
Tel: +359 2 980 1344  
parker.bulgaria@parker.com

**BY – Belarus, Minsk**  
Tel: +48 (0)22 573 24 00  
parker.poland@parker.com

**CH – Switzerland, Etoy**  
Tel: +41 (0)21 821 87 00  
parker.switzerland@parker.com

**CZ – Czech Republic, Klecany**  
Tel: +420 284 083 111  
parker.czechrepublic@parker.com

**DE – Germany, Kaarst**  
Tel: +49 (0)2131 4016 0  
parker.germany@parker.com

**DK – Denmark, Ballerup**  
Tel: +45 43 56 04 00  
parker.denmark@parker.com

**ES – Spain, Madrid**  
Tel: +34 902 330 001  
parker.spain@parker.com

**FI – Finland, Vantaa**  
Tel: +358 (0)20 753 2500  
parker.finland@parker.com

**FR – France, Contamine s/Arve**  
Tel: +33 (0)4 50 25 80 25  
parker.france@parker.com

**GR – Greece, Athens**  
Tel: +30 210 933 6450  
parker.greece@parker.com

**HU – Hungary, Budaörs**  
Tel: +36 23 885 470  
parker.hungary@parker.com

**IE – Ireland, Dublin**  
Tel: +353 (0)1 466 6370  
parker.ireland@parker.com

**IT – Italy, Corsico (MI)**  
Tel: +39 02 45 19 21  
parker.italy@parker.com

**KZ – Kazakhstan, Almaty**  
Tel: +7 7273 561 000  
parker.easteurope@parker.com

**NL – The Netherlands, Oldenzaal**  
Tel: +31 (0)541 585 000  
parker.nl@parker.com

**NO – Norway, Asker**  
Tel: +47 66 75 34 00  
parker.norway@parker.com

**PL – Poland, Warsaw**  
Tel: +48 (0)22 573 24 00  
parker.poland@parker.com

**PT – Portugal, Leca da Palmeira**  
Tel: +351 22 999 7360  
parker.portugal@parker.com

**RO – Romania, Bucharest**  
Tel: +40 21 252 1382  
parker.romania@parker.com

**RU – Russia, Moscow**  
Tel: +7 495 645-2156  
parker.russia@parker.com

**SE – Sweden, Spånga**  
Tel: +46 (0)8 59 79 50 00  
parker.sweden@parker.com

**SK – Slovakia, Banská Bystrica**  
Tel: +421 484 162 252  
parker.slovakia@parker.com

**SL – Slovenia, Novo Mesto**  
Tel: +386 7 337 6650  
parker.slovenia@parker.com

**TR – Turkey, Istanbul**  
Tel: +90 216 4997081  
parker.turkey@parker.com

**UA – Ukraine, Kiev**  
Tel: +48 (0)22 573 24 00  
parker.poland@parker.com

**UK – United Kingdom, Warwick**  
Tel: +44 (0)1926 317 878  
parker.uk@parker.com

**ZA – South Africa, Kempton Park**  
Tel: +27 (0)11 961 0700  
parker.southafrica@parker.com

## North America

**CA – Canada, Milton, Ontario**  
Tel: +1 905 693 3000

**US – USA, Cleveland**  
Tel: +1 216 896 3000

## Asia Pacific

**AU – Australia, Castle Hill**  
Tel: +61 (0)2-9634 7777

**CN – China, Shanghai**  
Tel: +86 21 2899 5000

**HK – Hong Kong**  
Tel: +852 2428 8008

**IN – India, Mumbai**  
Tel: +91 22 6513 7081-85

**JP – Japan, Tokyo**  
Tel: +81 (0)3 6408 3901

**KR – South Korea, Seoul**  
Tel: +82 2 559 0400

**MY – Malaysia, Shah Alam**  
Tel: +60 3 7849 0800

**NZ – New Zealand, Mt Wellington**  
Tel: +64 9 574 1744

**SG – Singapore**  
Tel: +65 6887 6300

**TH – Thailand, Bangkok**  
Tel: +662 186 7000

**TW – Taiwan, Taipei**  
Tel: +886 2 2298 8987

## South America

**AR – Argentina, Buenos Aires**  
Tel: +54 3327 44 4129

**BR – Brazil, Sao Jose dos Campos**  
Tel: +55 800 727 5374

**CL – Chile, Santiago**  
Tel: +56 2 623 1216

**MX – Mexico, Toluca**  
Tel: +52 72 2275 4200



### EMEA Product Information Centre

Free phone: 00 800 27 27 5374

(from AT, BE, CH, CZ, DE, DK, EE, ES, FI, FR, IE, IL, IS, IT, LU, MT, NL, NO, PL, PT, RU, SE, SK, UK, ZA)

### US Product Information Centre

Toll-free number: 1-800-27 27 537

www.parker.com