

# AC20 Series

## Variable Speed Drive

*Hardware Installation Manual*

DOC-0017-04-EN-B  
04.04.2023



ENGINEERING **YOUR** SUCCESS.

# 1 Safety Requirements

**IMPORTANT: Please read this information BEFORE installing the equipment.**

The contents of this manual have been verified against the associated hardware and software. Although every effort has been taken to ensure the accuracy of this document, it may be necessary without notice, to make amendments or correct omissions.

Parker Hannifin Manufacturing cannot accept responsibility for damage, injury, or expenses resulting there from.

## 1.1 Intended Users

This manual is to be made available to all persons who are required to install, configure or service equipment described herein, or any other associated operation.

The information given is intended to highlight safety issues, and to enable the user to obtain maximum benefit from the equipment.

## 1.2 Application Area





The equipment described is intended for industrial motor speed control utilising AC induction motors or PMAC motors.

## 1.3 Personnel

Installation, operation and maintenance of the equipment should be carried out by competent personnel. A competent person is someone who is technically qualified and familiar with all safety information and established safety practices; with the installation process, operation and maintenance of this equipment; and with all the hazards involved.



## 1.4 Product Warnings, Cautions and Information notices

Special attention must be paid to the information presented in warning, caution and information notices when they appear in this manual. Definitions of caution, warning and information notices are shown below:

	<b>DANGER</b> Risk of electric shock
	<b>WARNING</b> Hot surfaces
	<b>WARNING</b> Warns of danger to personnel. Refer to documentation. <b>CAUTION</b> Warns of danger to equipment. Refer to documentation.
	<b>EARTH / GROUND</b> Protective Earth Conductor Terminal
	<b>INFORMATION</b> Read further information before proceeding.

## 1.5 Hazards



### 1.5.1 Electric Shocks

	<b>DANGER!</b>	
	<b>Ignoring the following may result in injury:</b>	
	<ul style="list-style-type: none"><li>• This equipment can endanger life by exposure to rotating machinery and high voltages.</li><li>• The equipment must be permanently earthed due to the high earth leakage current, and the inverter motor must be connected to an appropriate safety earth.</li><li>• Ensure all incoming supplies are isolated before working on the equipment. Be aware that there may be more than one supply connection to the inverter.</li><li>• There may still be dangerous voltages present at power terminals (motor output, supply input phases, DC bus and the brake, where fitted) when the motor is at standstill or is stopped.</li><li>• For measurements use only a meter to IEC 61010 (CAT III or higher). Always begin using the highest range. CAT I and CAT II meters must not be used on this product.</li><li>• Allow at least 10 minutes for the inverter's capacitors to discharge to safe voltage levels (&lt;50V). Use the specified meter capable of measuring up to 1000V dc &amp; ac rms to confirm that less than 50V is present between all power terminals and between power terminals and earth.</li><li>• Unless otherwise stated, this product must NOT be dismantled. In the event of a fault the inverter must be returned. Refer to "Routine Maintenance and Repair".</li></ul>	



## 1.5.2 Safety & EMC Requirements

Where there is a conflict between safety and EMC requirements, personnel safety shall always take precedence.

### Safety

	<p><b>WARNING!</b></p> <p><b>Ignoring the following may result in injury or damage to equipment:</b></p> <ul style="list-style-type: none"> <li>• Never perform high voltage resistance checks on the wiring without first disconnecting the inverter from the circuit being tested.</li> <li>• Whilst ensuring ventilation is sufficient, provide guarding and /or additional safety systems to prevent injury or damage to equipment.</li> <li>• When replacing an inverter in an application and before returning to use, it is essential that all user defined parameters for the product's operation are correctly installed.</li> <li>• When replacing an inverter in an application and before returning to use, it is essential that all user defined parameters for the product's operation are correctly installed.</li> <li>• All control and signal terminals are SELV, i.e. protected by double insulation. Ensure all external wiring is rated for the highest system voltage.</li> <li>• Thermal sensors contained within the motor must have at least basic insulation.</li> <li>• All exposed metalwork in the Inverter is protected by basic insulation and bonded to a safety earth.</li> <li>• RCDs are not recommended for use with this product but, where their use is mandatory, only Type B RCDs should be used.</li> </ul>	
---	--	---



### EMC

	<p><b>WARNING!</b></p> <p><b>Ignoring the following may result in injury or damage to equipment:</b></p> <ul style="list-style-type: none"> <li>• In a domestic environment this product may cause radio interference in which case supplementary mitigation measures may be required.</li> <li>• This equipment contains electrostatic discharge (ESD) sensitive parts. Observe static control precautions when handling, installing and servicing this product.</li> <li>• This is a product of the restricted sales distribution class according to IEC 61800-3. It is designated as "professional equipment" as defined in EN61000-3-2 for AC20: Frame sizes 2 (excluding 1ø 2.2kW), &amp; 3 (400V products only). Permission of the supply authority shall be obtained before connection to the public low voltage supply. For all other Frame sizes not specified above, connection to the public LV supply must be agreed case by case between manufacturer, installer or user and distribution network operator.</li> </ul>	
---	---	---





## 1.5.3 Application Risk & Risk Assessment

### Application Risk

	<b>CAUTION!</b>	
<ul style="list-style-type: none"><li>• The specifications, processes and circuitry described herein are for guidance only and may need to be adapted to the user's specific application.</li><li>• Parker cannot guarantee the suitability of the equipment described in this Manual for individual applications.</li></ul>		

### Risk Assessment

	<b>CAUTION!</b>	
<ul style="list-style-type: none"><li>• Under fault conditions, power loss or unintended operating conditions, the inverter may not operate as intended. In particular:<ul style="list-style-type: none"><li>○ Stored energy might not discharge to safe levels as quickly as suggested and can still be present even though the inverter appears to be switched off.</li><li>○ The motor's direction of rotation might not be controlled.</li><li>○ The motor speed might not be controlled.</li><li>○ The motor might be energized.</li></ul></li><li>• An inverter is a component within an inverter system that may influence its operation or effects under a fault condition. Consideration must be given to:<ul style="list-style-type: none"><li>○ Stored energy</li><li>○ Supply disconnects</li><li>○ Sequencing logic</li><li>○ Unintended operation</li></ul></li></ul>		

## 2 Manufacturing Location

### Germany

Parker Hannifin Manufacturing Germany GmbH & Co. KG

Electric Motion & Pneumatic Division (EMPD)

Robert-Bosch-Strasse 22

77656 Offenburg (Germany)

Tel.: + 49 (0781) 509-0

Website: [www.parker.com/eme](http://www.parker.com/eme)

Certified according to ISO 9001:2015

Parker Hannifin Manufacturing Germany GmbH & Co. KG - Sitz: Bielefeld - Amtsgericht: Bielefeld HRA 15699  
persönlich haftende Gesellschafterin: Parker Hannifin GmbH - Sitz: Bielefeld - Amtsgericht Bielefeld HRB 35489  
Geschäftsführung der Parker Hannifin GmbH: Ulrich Jochem, Achim Kohler, Andreas Paulsen, Kirsten Stenvers  
Vorsitzender des Aufsichtsrates: Dr.-Ing. Gerd Scheffel

## 3 Table of Contents

<b>1</b>	<b>Safety Requirements.....</b>	<b>2</b>
1.1	Intended Users.....	2
1.2	Application Area.....	2
1.3	Personnel.....	2
1.4	Product Warnings, Cautions and Information notices.....	2
1.5	Hazards.....	3
1.5.1	Electric Shocks.....	3
1.5.2	Safety & EMC Requirements.....	4
1.5.3	Application Risk & Risk Assessment.....	5
<b>2</b>	<b>Manufacturing Location.....</b>	<b>6</b>
<b>3</b>	<b>Table of Contents.....</b>	<b>6</b>
<b>4</b>	<b>Introduction.....</b>	<b>10</b>
4.1	About this Hardware Installation Manual.....	10
4.1.1	Users.....	10
4.1.2	Manual Organisation.....	10
4.1.3	Manual Revision.....	10
4.2	Before You Start.....	10
4.2.1	Equipment Inspection.....	10
4.2.2	Equipment Storage.....	10
4.2.3	Initial Steps.....	11
4.2.4	Unpacking the Product.....	11
<b>5</b>	<b>Product Overview.....</b>	<b>12</b>
<b>6</b>	<b>Installation.....</b>	<b>15</b>
6.1	Mechanical.....	15
6.1.1	Product Dimensions & Weights.....	15
6.1.2	Product Fixing Dimensions.....	17
6.1.3	Lifting the Inverter.....	18
6.1.4	Mounting the Inverter.....	19
6.1.5	Ventilation Clearance Requirements.....	20
6.1.6	Wiring Bracket (Frames 2 – 5).....	22
6.2	Electrical.....	23
6.2.1	Power Stack Wiring.....	23
6.2.2	Control Board Wiring.....	38
6.2.3	Control Board Communications Wiring.....	43
6.3	Option Cards.....	45
6.3.1	Order Codes.....	45
6.3.2	Installation.....	45
6.3.3	Wiring.....	47
6.4	Communication Interface Option Cards.....	50
6.4.1	Order Codes.....	50
6.4.2	Installation.....	50
6.5	µSD Memory Card.....	54
6.5.1	Installation.....	54
6.6	Remote Mounted 6901 MMI.....	56
6.6.1	Order Codes.....	56
6.6.2	Installation.....	56
6.6.3	Cable Connection.....	57
<b>7</b>	<b>Associated Equipment.....</b>	<b>59</b>
7.1	AC Line Fuses.....	60
7.1.1	1ø, 230V Products.....	60
7.1.2	3ø, 230V Products.....	60
7.1.3	3ø, 400V Products.....	60
7.2	External EMC Filter.....	61
7.3	AC Line Choke.....	61
7.3.1	1ø, 230V Products.....	61
7.3.2	3ø, 230V Products.....	61
7.3.3	3ø, 400V Products.....	62
7.3.4	Calculation.....	62

7.4	Dynamic Braking Resistor.....	63
7.4.1	Resistor Power Requirement Calculation.....	63
7.4.2	Resistor Selection.....	63
7.4.3	Resistor Protection Devices.....	64
7.5	AC Motor Choke.....	65
7.5.1	1 $\phi$ , 230V Products.....	65
7.5.2	3 $\phi$ , 230V Products.....	66
7.5.3	3 $\phi$ , 400V Products.....	66
7.5.4	Calculation.....	67
<b>8</b>	<b>Safe Torque Off (STO): SIL2, PLd.....</b>	<b>68</b>
8.1	Overview.....	68
8.1.1	Introduction.....	68
8.1.2	STO Functional Description.....	69
8.2	Alignment to European Standards.....	69
8.2.1	EN ISO13849-1:2015 (Safety of machinery – Safety-related parts of control systems).....	69
8.2.2	EN61800-5-2:2017 (Adjustable speed electrical power drive systems) & EN61508:2010 (Functional safety of electrical/electronic/programmable electronic safety-related systems).....	70
8.3	Specification.....	70
8.3.1	Safety.....	70
8.3.2	EMC.....	71
8.4	STO Operation.....	71
8.4.1	Terminal Identifications.....	71
8.4.2	Input State Truth Table.....	72
8.4.3	Example Applications.....	72
8.4.4	Technical Specification.....	77
8.5	STO Safety Warnings & Limitations.....	77
8.6	STO Functional Checks.....	79
8.6.1	Comprehensive Checks.....	80
8.6.2	Test Protocol Specimen.....	82
8.6.3	Regular Checks.....	82
8.7	STO Troubleshooting.....	83
<b>9</b>	<b>Basic Drive Operation.....</b>	<b>84</b>
9.1	'Local' Operation.....	84
9.1.1	Minimum Connections.....	84
9.1.2	Onboard Drive Keypad & Display Overview.....	85
9.1.3	6901 Remote Keypad & Display Overview.....	87
9.1.4	Keypad Menu Navigation Examples.....	89
9.1.5	Basic Drive Setup.....	90
9.2	'Remote' Operation (Using Pre-Defined Macro's).....	98
9.2.1	Enable 'Remote' Control Mode.....	98
9.2.2	Selecting & Loading A Macro.....	98
9.2.3	Running The Drive.....	99
9.2.4	Application '1': Standard (Basic Speed Control).....	100
9.2.5	Application '2': Auto / Manual.....	101
9.2.6	Application '3': Presets.....	102
9.2.7	Application '4': Raise / Lower.....	103
9.2.8	Application '5': PID.....	104
9.2.9	Application '6': Aux Comms.....	105
9.3	External +24V Power-Up Mode.....	106
9.3.1	24V Active Functionality.....	106
<b>10</b>	<b>Routine Maintenance &amp; Repair.....</b>	<b>107</b>
10.1	Routine Maintenance.....	107
10.2	Preventative Maintenance.....	107
10.2.1	Main Duct Cooling Fans.....	107
10.2.2	DC Link Capacitors.....	107
10.3	Repair.....	107
<b>11</b>	<b>Compliance.....</b>	<b>108</b>
11.1	Applicable Standards.....	108
11.2	European Compliance.....	108
11.2.1	CE Marking.....	108
11.2.2	EMC Compliance.....	110
11.2.3	EMC Standards.....	110
11.2.4	EMC Installation Guidance.....	117
11.2.5	Harmonic Information.....	123

11.3	North American & Canadian Compliance .....	133
11.3.1	North American Compliance .....	133
11.3.2	Canadian Compliance .....	133
11.3.3	North American & Canadian Compliance Information .....	133
11.4	Environmental Compliance .....	135
11.4.1	REACH (Restriction, Evaluation, Authorisation & Restriction of Chemicals) .....	135
11.4.2	RoHS (Restriction of Hazardous Substances) .....	135
11.4.3	WEEE (Waste Electrical & Electronic Equipment) .....	135
<b>12</b>	<b>AC20 Series Product Codes .....</b>	<b>136</b>
<b>13</b>	<b>Technical Information .....</b>	<b>137</b>
13.1	General Product Ratings .....	137
13.1.1	Environment .....	137
13.1.2	Safety .....	137
13.1.3	Earthing .....	137
13.1.4	Mains Supply .....	137
13.2	AC Line Fed Power Stack Ratings .....	138
13.2.1	1 $\emptyset$ , 230V Products .....	138
13.2.2	3 $\emptyset$ , 230V Products .....	138
13.2.3	3 $\emptyset$ , 400V Products .....	138
13.3	Internal Brake Switch Ratings .....	139
13.3.1	1 $\emptyset$ , 230V Products .....	139
13.3.2	3 $\emptyset$ , 230V Products .....	139
13.3.3	3 $\emptyset$ , 400V Products .....	140
13.4	Control Board Ratings .....	140
13.4.1	Analogue Inputs .....	140
13.4.2	Analogue Outputs .....	141
13.4.3	Digital Inputs .....	141
13.4.4	Digital Outputs .....	142
13.4.5	Relay Outputs .....	142
13.4.6	Motor Thermistor Input .....	142
13.4.7	User +24V Output .....	142
13.4.8	External +24V Auxiliary Input .....	143
13.4.9	STO Inputs .....	143
13.5	Encoder Feedback Option Card Ratings .....	144
13.5.1	Encoder Inputs .....	144
13.5.2	Power Supply Output .....	144
13.6	GPIO Option Card Ratings .....	145
13.6.1	Analogue Inputs .....	145
13.6.2	Analogue Outputs .....	145
13.6.3	Digital Input .....	145
13.6.4	Digital Output .....	146
13.6.5	+10V Reference Voltage Output .....	146
13.6.6	-10V Reference Voltage Output .....	146
<b>Appendix A:</b>	<b>Power Stack Circuit Overview .....</b>	<b>147</b>
	1 $\emptyset$ , 230V Products .....	147
	3 $\emptyset$ , 230V Products .....	147
	3 $\emptyset$ , 400V Products .....	149

## 4 Introduction

### 4.1 About this Hardware Installation Manual

#### 4.1.1 Users

This Manual is intended for use by the installer of the AC20 series Inverters. It assumes a reasonable level of understanding in this discipline.

There is a separate Software Reference Manual – DOC-0017-13 “AC20 Series – Software Reference Manual”, that is intended for use by the user and programmer of the AC20 series Inverters.

#### 4.1.2 Manual Organisation

This Hardware Installation Manual is organised into chapters, indicated by the numbering on the edge of each page.

If the manual is to be printed, it is designed so that it should be printed double-sided using the long-edge for binding.

The Manual is ordered in a sequence that takes the user through the product installation process, resulting in the basic operation of the drive.

Information for the full AC20 product is referred to as “the Inverter” or “drive” throughout the manual.

Product coding: Any “x” within a product code indicates there are variants. See ‘Chapter 12: AC20 Series Product Codes’ section for more information.

#### 4.1.3 Manual Revision

This revision replaces all previous revisions of this document. Parker has made every effort to ensure that this document is complete and accurate at the time of printing. In accordance with our policy of continuous product improvement, all data in this document is subject to change or correction without prior notice.

### 4.2 Before You Start...

#### 4.2.1 Equipment Inspection

At the point of receipt of your product, check:

- For signs of transit damage.
- That the product code on the box label matches your order.

#### 4.2.2 Equipment Storage

If the product is not being installed immediately, store the unit:

- In a well-ventilated place.
- Away from high temperatures and humidity,
- Away from dust or metal particles.

<b>Storage Temperature:</b>	-25°C to 55°C
<b>Shipping Temperature:</b>	-25°C to 70°C

### 4.2.3 Initial Steps

Use this Hardware Installation Manual to help plan the following:

#### 1. Installation

Know your requirements:

- Certification, i.e. CE, UL, CUL compliance (Chapter 11: Compliance).
- Conformance to local installation requirements.
- Supply and Cabling requirements (Chapter 6: Installation).

#### 2. Motor Considerations

It is important to consider that:

- The motor used with the Inverter is suitable for Inverter duty.
- The rated current of the motor used with the Inverter is not less than 25% of the Inverter current rating. If this is the case, poor motor control or autotune problems may occur.

### 4.2.4 Unpacking the Product

When unpacking the product:

- Save the packaging. In case of the need to return the product, improper packaging can result in transit damage.
- Use safe and suitable lifting procedure when moving the unit. Never lift the unit by its terminal connections.
- Prepare a clear, flat surface to receive the inverter before attempting to move it. Do not damage any terminal connections when putting the unit down.
- Refer to 'Chapter 6: Installation' for further details on handling the products.

## 5 Product Overview



General Overview:	
<b>Power Range:</b>	1.5 – 180kW
<b>Frame Sizes:</b>	9 (Frames 2 – 10)
<b>Power Supply:</b>	1ø 220 – 240Vac ±10%, (Frame 2: 1.5 – 2.2kW) 3ø 220 – 240Vac ±10%, (Frames 2 - 5: 1.5 – 11kW) 3ø 380 – 480Vac ±10%, (Frames 2 - 10: 1.5 – 180kW)
<b>Input Frequency:</b>	50/60Hz ±10%
<b>Output Frequency:</b>	0.5 – 590Hz
<b>Safe Torque Off (STO):</b>	SIL2, PLd
<b>Environment:</b>	<p><b>Temperature:</b> 0 - 40°C (derate output current above 40°C by 2% per °C, up to maximum of 45°C) <b>Note: Anybus Options not suitable for use in temperatures &gt;40°C.</b></p> <p><b>Altitude:</b> 0 – 1000m (derate output current above 1000m by 1% per 100m, up to maximum of 2000m)</p>



General Power Stack Features:	
<b>Switching Frequency:</b>	Minimum: 1kHz Default: <ul style="list-style-type: none"> <li>- Frames 2 – 6: 4kHz</li> <li>- Frame 7: 3kHz</li> <li>- Frames 8 – 10: 2kHz</li> </ul> Maximum: <ul style="list-style-type: none"> <li>- Frames 2 – 6 (1.5 – 37kW): 10kHz</li> <li>- Frame 6 (45kW): 6kHz</li> <li>- Frame 7: 8kHz</li> <li>- Frames 8 – 10: 4kHz</li> </ul> Linear derating of output current will apply above the default switching frequency (varies by power rating. Refer to Chapter 13: Technical Information for values).
<b>Output Frequency:</b>	Induction Motors: <ul style="list-style-type: none"> <li>- Maximum = Switching Frequency ÷ 8</li> </ul> PMAC Motors: <ul style="list-style-type: none"> <li>- Maximum = Switching Frequency ÷ 6</li> </ul> <b>Note: Output frequency is limited to a maximum frequency of 590Hz due to export rules.</b>
<b>Duty Rating:</b>	Heavy Duty (HD)
Power Stack Protection Features:	
<b>Trip Conditions:</b>	Output Short Circuit Overcurrent: 220% Rated Output Current Motor Stall Overvoltage / Undervoltage: <ul style="list-style-type: none"> <li>- 230V products = 420Vdc / 220Vdc</li> <li>- 400V products = 840Vdc / 410Vdc</li> </ul> Heatsink Overtemperature Motor Thermistor Overtemperature Three Phase OK (Missing Line Phase Detection): <ul style="list-style-type: none"> <li>- 3ø 230V products: Frames 3 – 5 only</li> <li>- 3ø 400V products: Frames 4 – 10 only</li> </ul>
<b>Current Limit:</b>	Adjustable up to 150%
<b>Overload Rating:</b>	150% for 60s (Inverse Time / Motor I*t)
User Terminals:	
<b>Line Input:</b>	3x Three phase / 2x Single phase AC input terminals: L1/L, L2/N, L3
<b>Motor Output:</b>	3x AC output terminals: U, V, W
<b>Brake Output:</b>	2x DC output terminals: DC+, DBR
<b>PE:</b>	Minimum of 2x Protective earth connections
General Control Features:	
<b>Motor Control Modes:</b>	Induction Motors: <ul style="list-style-type: none"> <li>- V/F Control (V/Hz)</li> <li>- Sensorless Vector Control</li> <li>- Closed Loop Vector Control (with Encoder Feedback Option Board)</li> </ul> PMAC Motors: <ul style="list-style-type: none"> <li>- Sensorless Vector Control</li> </ul>
<b>Voltage Boost for V/F Control:</b>	0-25%

<b>Skip Frequencies:</b>	Skip frequencies with adjustable skip band width
<b>Preset Speeds:</b>	User selectable preset speeds
<b>Stopping Modes:</b>	Ramp, Coast, DC Injection, Fast Stop
<b>Linear &amp; S Ramps:</b>	Symmetric or asymmetric ramp up and down rates
<b>Raise/Lower:</b>	Programmable Motorised Potentiometer (MOP) function
<b>Jog:</b>	Programmable jog speed
<b>Diagnostics:</b>	Real-time drive feedback monitoring and fault diagnostics
<b>Base Control Board I/O:</b>	
<b>Analogue Inputs:</b>	2x Configurable Inputs: Voltage Mode ( $\pm 10V$ , 0-10V) / Current Mode (0-20mA, 4-20mA)
<b>Analogue Outputs:</b>	3x Configurable Outputs: <ul style="list-style-type: none"> <li>- 2x Voltage Mode (0-10V) / Current Mode (0-20mA)</li> <li>- 1x Voltage Mode (<math>\pm 10V</math>, 0-10V)</li> </ul>
<b>Digital Inputs:</b>	Frames 2 – 5: <ul style="list-style-type: none"> <li>- Up to 8x Configurable 24Vdc Inputs (5x Dedicated Inputs with common selectable pull-ups for active low operation)</li> </ul> Frames 6 – 10: <ul style="list-style-type: none"> <li>- Up to 10x Configurable 24Vdc Inputs (7x Dedicated Inputs with common selectable pull-ups for active low operation)</li> </ul>
<b>Digital Outputs:</b>	Up to 3x Configurable 24Vdc Outputs
<b>Relay Outputs:</b>	2x Configurable Relay Outputs
<b>User +24V Output:</b>	1x User +24V Reference Voltage Output
<b>External +24V Auxiliary Input:</b>	1x +24Vdc Input (PELV)
<b>Additional I/O with Optional Encoder Feedback Board(s) Fitted (up to 2x):</b>	
<b>Encoder Inputs:</b>	1x (or 2x) Encoder Input Channels: A, /A, B, /B
<b>Power Supply Output:</b>	1x (or 2x) Selectable Encoder Output Supply Voltage: 5V, 12V, 15V or 20V
<b>Additional I/O with General Purpose Input/Output (GPIO) Board(s) Fitted (up to 2x):</b>	
<b>Analogue Inputs:</b>	2x (or 4x) Additional Configurable Inputs: Voltage Mode ( $\pm 10V$ , 0-10V)
<b>Analogue Outputs:</b>	1x (or 2x) Additional Configurable Output(s): Voltage Mode ( $\pm 10V$ , 0-10V)
<b>Digital Inputs:</b>	1x (or 2x) Additional Configurable 24Vdc Input(s)
<b>Digital Outputs:</b>	1x (or 2x) Additional Configurable 24Vdc Output(s)
<b>Reference Voltage Outputs:</b>	1x (or 2x) +10Vdc Output(s), 1x (or 2x) -10Vdc Output(s)
<b>Base Communication Ports:</b>	
<b>Ethernet:</b>	1x RJ45 Port: <ul style="list-style-type: none"> <li>- DSELite / Web HTTP Server / Modbus TCP / EtherNet/IP / Profinet IO</li> </ul>
<b>RS232:</b>	Frames 2 – 5: <ul style="list-style-type: none"> <li>- 1x RJ11 Port for remote 6901 MMI</li> </ul> Frames 6 – 10: <ul style="list-style-type: none"> <li>- 1x RJ11 Port for onboard 6901 MMI</li> <li>- 1x RJ11 Port for remote 6901 MMI</li> </ul>

## 6 Installation



### IMPORTANT

Please ensure that you have read and are familiar with the 'Compliance' chapter before installing the unit.



## 6.1 Mechanical

### 6.1.1 Product Dimensions & Weights

Frames 2 – 6:

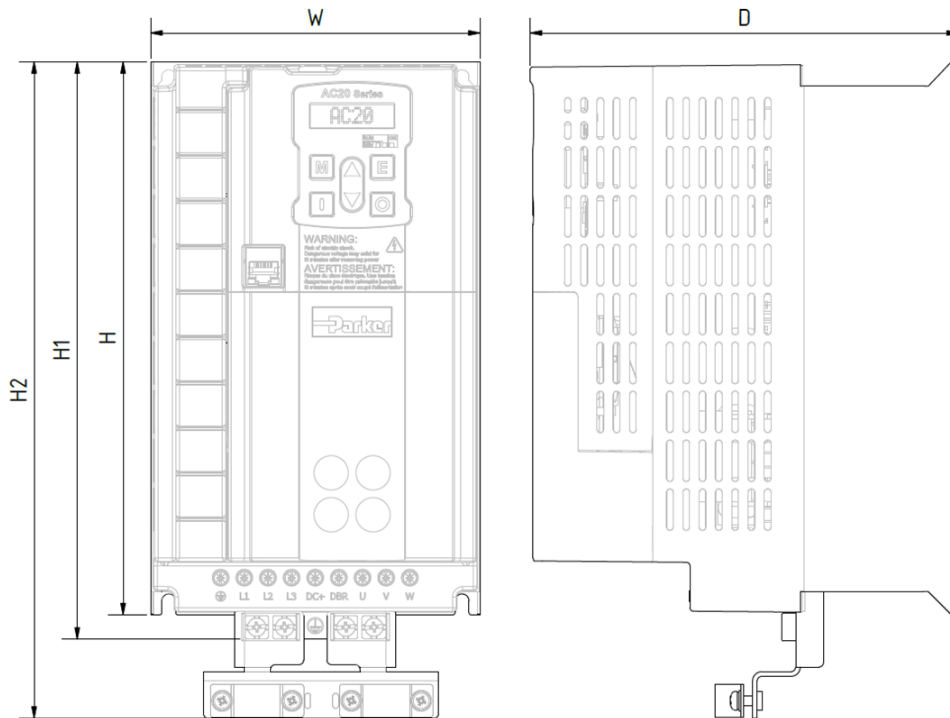

Frame Size	Product Dimensions					Weight
	H	H1	H2	W	D	
2	180.0 (7.09)	193.0 (7.60)	227.5 (8.96)	108.4 (4.27)	185.0 (7.28)	2.0 (4.41)
3	237.5 (9.35)	248.0 (9.76)	281.9 (11.10)	141.6 (5.57)	184.0 (7.24)	3.3 (7.28)
4	265.0 (10.43)	283.0 (11.14)	321.4 (12.65)	161.0 (6.34)	196.0 (7.72)	4.4 (9.70)
5	340.0 (13.39)	358.0 (14.09)	401.4 (15.80)	210.0 (8.27)	220.2 (8.67)	8.0 (17.64)
6	435.0 (17.13)	465.0 (18.31)	n/a	262.0 (10.31)	240.5 (9.47)	13.0 (28.66)

All dimensions in millimeters (*inches*)

All weights in kilograms (*lbs*)

**Frames 7 – 10:**

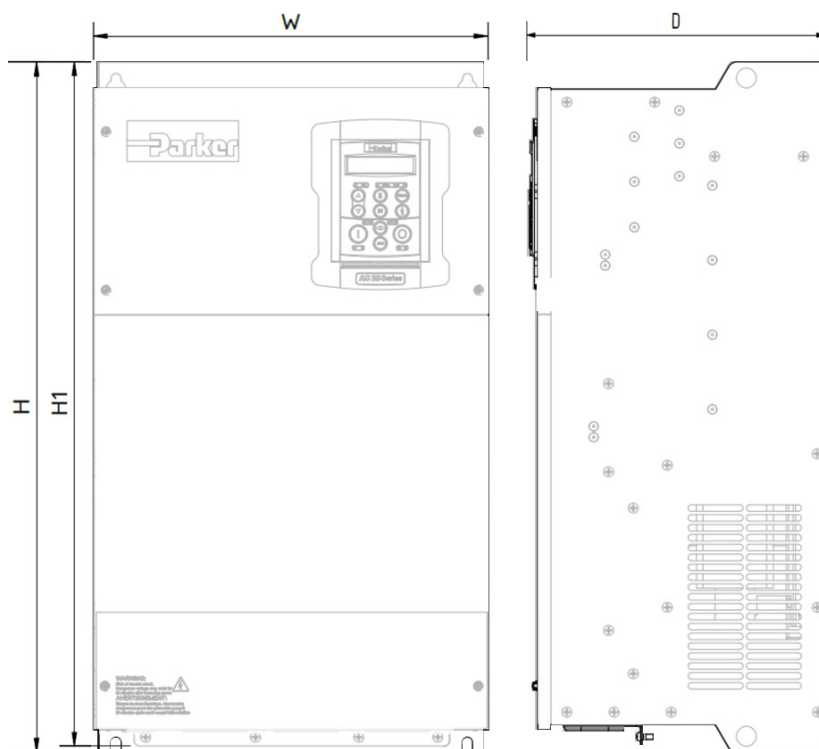

Frame Size	Product Dimensions					Weight
	H	H1	H2	W	D	
<b>7</b>	630.0 (24.80)	623.5 (24.55)	n/a	355.0 (13.98)	265.0 (10.43)	36.0 (79.37)
<b>8</b>	765.0 (30.12)	755.0 (29.72)	n/a	406.0 (15.98)	300.0 (11.81)	52.0 (114.64)
<b>9</b>	765.0 (30.12)	778.0 (30.63)	n/a	510.0 (20.08)	326.0 (12.83)	83.0 (182.98)
<b>10</b>	910.0 (35.83)	925.0 (36.42)	n/a	550.0 (21.65)	341.5 (13.44)	100.0 (220.46)

All dimensions in millimeters (*inches*)

All weights in kilograms (*lbs*)

### 6.1.2 Product Fixing Dimensions

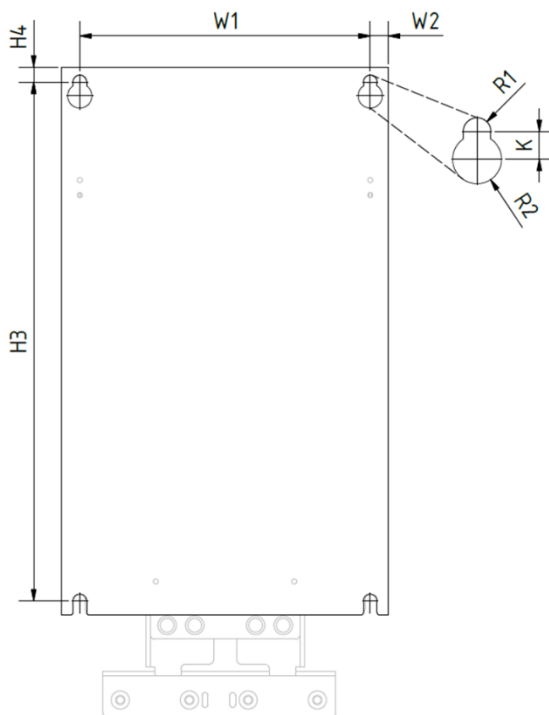

Frame Size	Fixing Dimensions				Slot Size			Fixings
	H3	H4	W1	W2	K	R1	R2	
2	170.0 (6.69)	5.0 (0.20)	94.0 (3.70)	7.2 (0.28)	5.0 (0.20)	2.3 (0.09)	4.7 (0.19)	M4
3	225.0 (8.86)	6.5 (0.26)	126.0 (4.96)	7.8 (0.31)	6.0 (0.24)	3.0 (0.12)	5.3 (0.21)	M5
4	255.0 (10.04)	5.0 (0.20)	146.0 (5.75)	7.5 (0.30)	5.0 (0.20)	2.5 (0.10)	4.6 (0.18)	M5
5	329.0 (12.95)	5.5 (0.22)	194.0 (7.64)	8.0 (0.31)	6.0 (0.24)	3.0 (0.12)	5.5 (0.22)	M5
6	412.0 (16.22)	11.5 (0.45)	235.0 (9.25)	13.5 (0.53)	8.0 (0.31)	3.3 (0.13)	6.0 (0.24)	M6
7	605.0 (23.82)	15.0 (0.59)	320.0 (12.60)	17.5 (0.69)	10.0 (0.39)	4.5 (0.18)	9.0 (0.35)	M8
8	740.0 (29.13)	15.0 (0.59)	370.0 (14.57)	18.0 (0.71)	13.0 (0.51)	5.5 (0.22)	11.0 (0.43)	M10
9	740.0 (29.13)	12.5 (0.49)	360.0 (14.17)	75.0 (2.95)	13.0 (0.51)	5.5 (0.22)	10.5 (0.41)	M10
10	882.0 (34.72)	13.0 (0.51)	390.0 (15.35)	80.0 (3.15)	17.0 (0.67)	5.5 (0.22)	11.0 (0.43)	M10

All dimensions in millimeters (inches)

### 6.1.3 Lifting the Inverter

**CAUTION!**  
**HEAVY OBJECT**



- Always ensure that all lifting equipment is suitably sized to support the weight of the product.
- These models are heavy and will require the use of a forklift or hoist to lift and install it into position.
- Pay attention to the centre of gravity of the product. This is marked on the product packaging.



#### Frames 2 – 6:

These products can be lifted by an individual. Care must be taken when handling the products to avoid injury.

#### Frame 7:

A forklift, or two people, are required when handling this frame size. Again, care must be taken to avoid injury.

This product will stand up vertically on a flat surface.

#### Frames 8 – 10:

A forklift is required for handling these frame sizes. Lifting eyes are available for use during this process. Hooks and lifting slings should be used to lift the inverter out of its packaging and to stand it up vertically on a flat surface, before moving it to a new location:

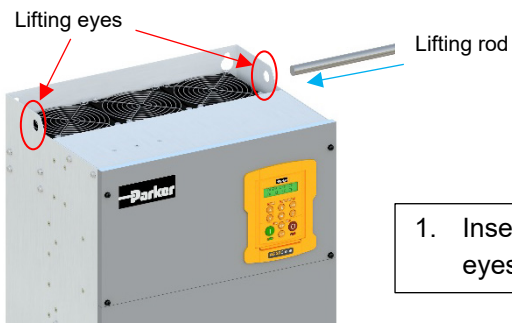

1. Insert a lifting rod through the lifting eyes at the top of the product.



2. Use a forklift to lift the inverter using the lifting rod.

With the inverter hanging vertically on the forklift with the lifting rod, it is now free to be maneuvered into its installation location.



## 6.1.4 Mounting the Inverter

These products are intended to be mounted vertically inside a suitable enclosure.



1. Mark out the fixing hole positions on the cubicle back panel as per the Fixing Dimensions listed in the table above.
2. Drill the fixing holes as per the Slot Size and required Fixing as listed in the table above.
3. Screw the fixings part way into the cubicle back panel.
4. Lift the inverter into position (via suitable means) and onto the fixings using the keystone slots at the top of the product to hang the inverter into position.
5. Secure the product by fully tightening the fixings.
6. The inverter is now ready for wiring.

### 6.1.5 Ventilation Clearance Requirements

The inverter gives off heat in normal operation and must therefore be mounted to allow the free flow of air through the ventilation slots and heatsink:

- Maintain minimum clearances for ventilation as given in the tables below to ensure adequate cooling of the inverter, and that heat generated by other adjacent equipment is not transmitted to the inverter.
- Be aware that other equipment may have its own clearance requirements.
- When mounting two or more inverters together, these clearances are additive.
- Ensure that the mounting surface is normally cool.
- The inverter must be mounted in a suitable cubicle.

**Frames 2 – 6:**

**Minimum Air Clearance for Product:**

Frame 3 is shown for illustration only.

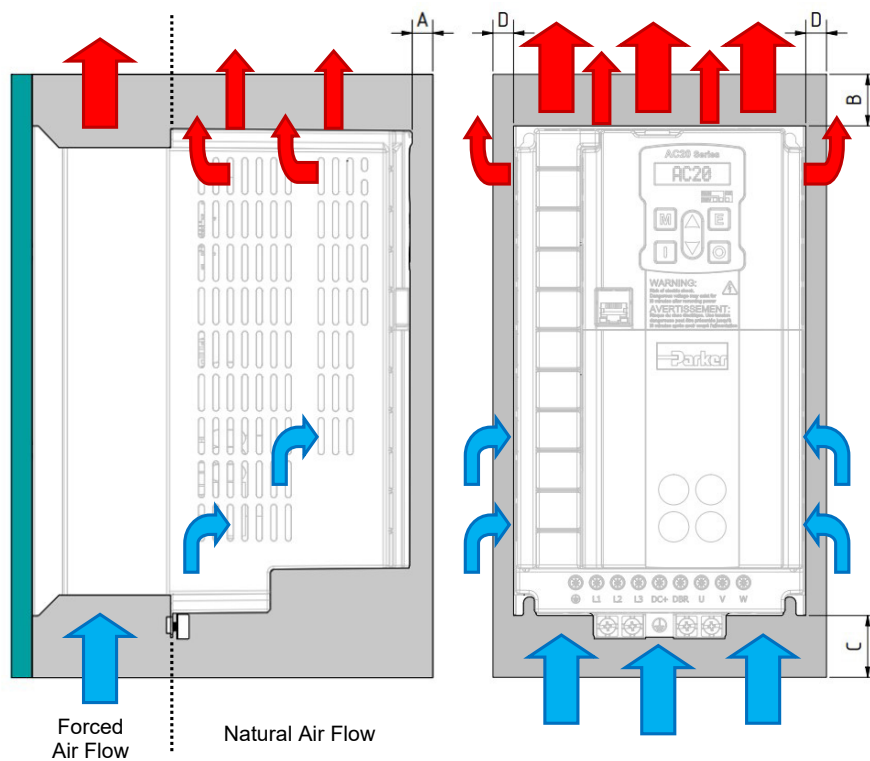

Frame Size	Product Clearances			
	A	B	C	D
2	10.0 (0.39)	150.0 (5.91)	150.0 (5.91)	50.0 (1.97)
3	10.0 (0.39)	150.0 (5.91)	150.0 (5.91)	50.0 (1.97)
4	10.0 (0.39)	150.0 (5.91)	150.0 (5.91)	50.0 (1.97)
5	10.0 (0.39)	150.0 (5.91)	150.0 (5.91)	50.0 (1.97)
6	10.0 (0.39)	200.0 (7.87)	150.0 (5.91)	50.0 (1.97)

All dimensions in millimeters (inches)

Note: The wiring bracket (Frames 2-5 only), does not affect the clearance dimension below the product (dimension C).



**Frames 7 – 10:**

**Minimum Air Clearance for Product:**

Frame 7 is shown for illustration only.

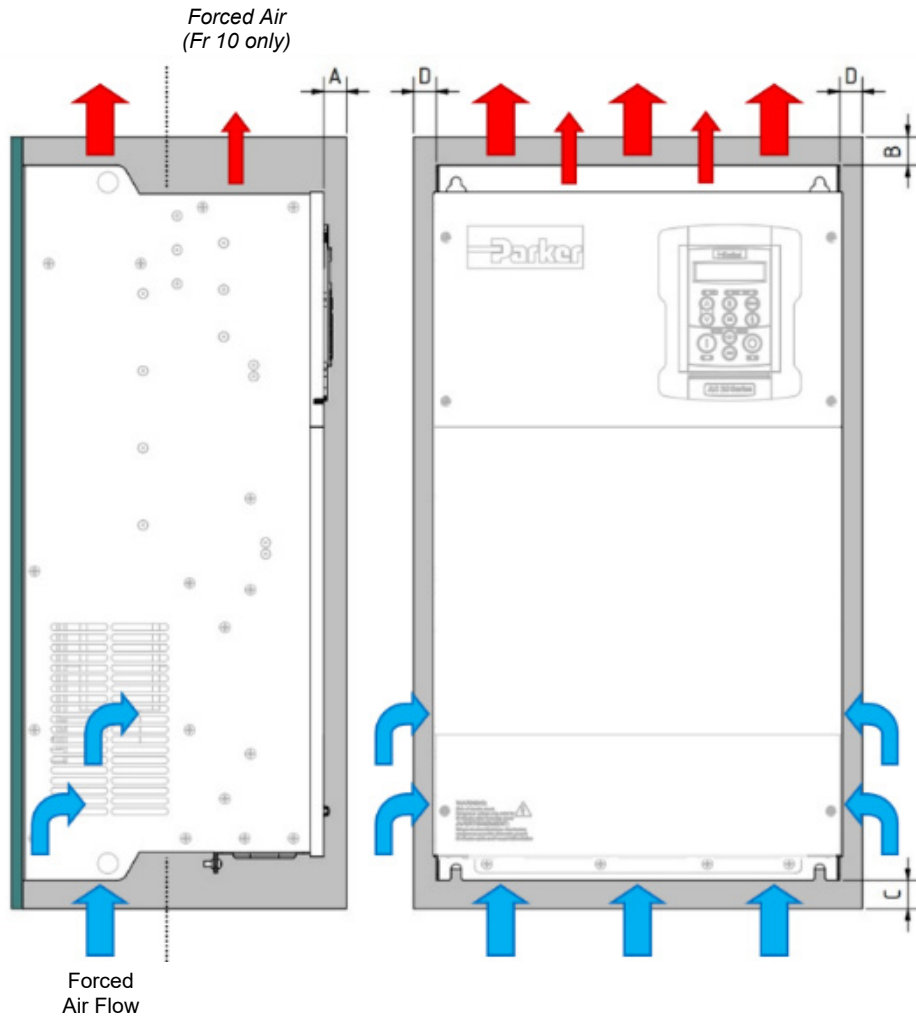

Frame Size	Product Clearances			
	A	B	C	D
7	10.0 (0.39)	200.0 (7.87)	200.0 (7.87)	50.0 (1.97)
8	10.0 (0.39)	200.0 (7.87)	200.0 (7.87)	50.0 (1.97)
9	10.0 (0.39)	200.0 (7.87)	200.0 (7.87)	50.0 (1.97)
10	10.0 (0.39)	200.0 (7.87)	200.0 (7.87)	50.0 (1.97)

All dimensions in millimeters (inches)

### 6.1.6 Wiring Bracket (Frames 2 – 5)

Wiring brackets are supplied with the AC20 product range (Frames 2-5 only). These brackets support the cabling to and from the drive, as well as providing a convenient means to achieve a 360° connection to the cable screen.

#### Replacement Order Codes

Order Code	Description
ASP-0039-02	AC20 Wiring Bracket Kit - Frame 2
ASP-0039-03	AC20 Wiring Bracket Kit - Frame 3, 400V
ASP-0039-04	AC20 Wiring Bracket Kit - Frame 4, 400V
ASP-0039-05	AC20 Wiring Bracket Kit - Frame 5, 400V
ASP-0039-06	AC20 Wiring Bracket Kit - Frame 3, 230V
ASP-0039-07	AC20 Wiring Bracket Kit - Frame 4, 230V
ASP-0039-08	AC20 Wiring Bracket Kit - Frame 5, 230V

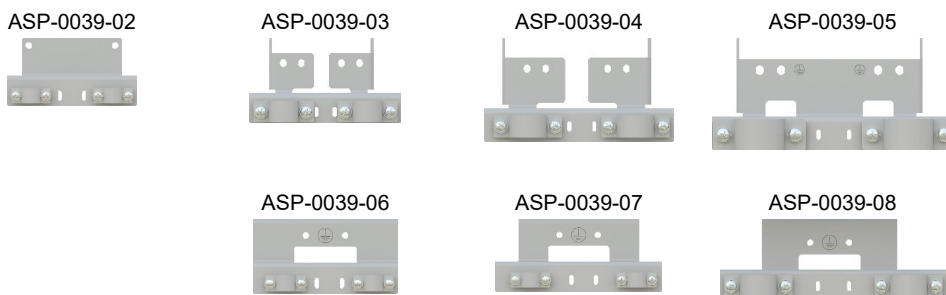

#### Installation

The Wiring Brackets mount to the chassis earthing points using the clamps and fixings pre-installed to the drive. Frame 2 is shown for illustration only:

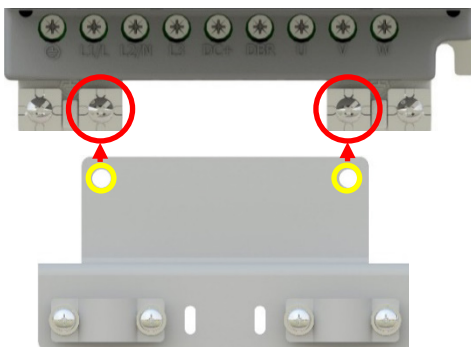

1. Unscrew and remove the necessary chassis PE clamps.
2. Align and place the wiring bracket onto the bare chassis PE tabs.

3. Secure the wiring bracket to the chassis with the previously removed clamps and screws (from step 1).

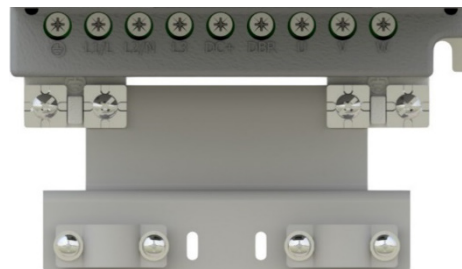

For the Frame 3, 4 & 5 230V products:

1. Remove the fixings of the 'L' brackets (with the earth clamps attached), from the heatsink.
2. Replace the 'L' brackets with the wiring bracket, reusing the heatsink fixings.
3. Move the earth clamps across from the 'L' brackets and fit onto the wiring bracket.

## 6.2 Electrical



### IMPORTANT

Please ensure that you have read and are familiar with the 'Safety' chapter before proceeding with the electrical installation.



### DANGER!

#### RISK OF ELECTRIC SHOCK



Terminal covers, main covers, and cover fixings must remain in place while the drive is energised.

These should only ever be removed once the supply to the unit and/or system has been disconnected, and the residual energy in the DC link capacitors has been discharged.



- All activities covered in this chapter should be carried out when there is no power to the inverter.
- If the drive has been powered up, ensure enough time has elapsed that the inverter has discharged its residual energy.
- Always check that the voltages on the user terminals are at a safe level (<50V) before carrying out any of these activities.
- STO always overrides any attempt to start the inverter. If one or both STO control inputs is requesting the STO function, the inverter will not start.
- Refer to 'Chapter 8: Safe Torque Off (STO): SIL2, PLd' for further information.

### 6.2.1 Power Stack Wiring

#### Terminal Identification

Frame 2:



Label	Description
PE	Protective Earth
L1 / L	Supply Input Phase L1 / Live
L2 / N	Supply Input Phase L2 / Neutral
L3	Supply Input Phase L3
DC+	DC+ / Dynamic Brake Resistor Connection (+)
DBR	Dynamic Brake Resistor Connection (-)
U	Motor Output Phase U
V	Motor Output Phase V
W	Motor Output Phase W

**Frames 3 & 4:**



Label	Description
PE	Protective Earth
L1	Supply Input Phase L1
L2	Supply Input Phase L2
L3	Supply Input Phase L3
DC+	DC+ / Dynamic Brake Resistor Connection (+)
DBR	Dynamic Brake Resistor Connection (-)
U	Motor Output Phase U
V	Motor Output Phase V
W	Motor Output Phase W

**Frame 5:**



Label	Description
PE	Protective Earth
L1	Supply Input Phase L1
L2	Supply Input Phase L2
L3	Supply Input Phase L3
DC+	DC+ / Dynamic Brake Resistor Connection (+)
DC-	DC-
DBR	Dynamic Brake Resistor Connection (-)
U	Motor Output Phase U
V	Motor Output Phase V
W	Motor Output Phase W

**Frame 6:**

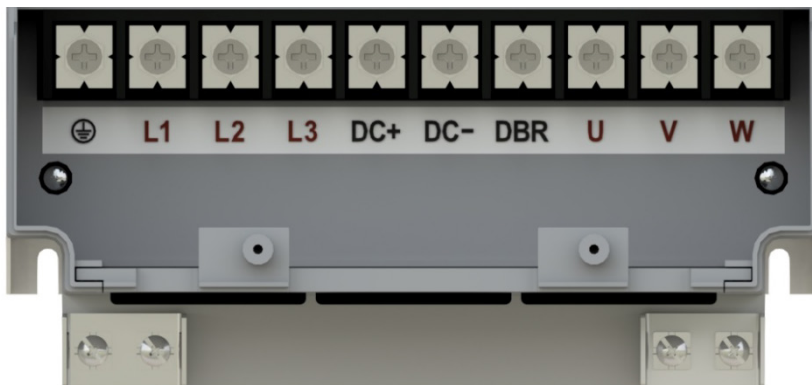

Label	Description
PE	Protective Earth
L1	Supply Input Phase L1
L2	Supply Input Phase L2
L3	Supply Input Phase L3
DC+	DC+ / Dynamic Brake Resistor Connection (+)
DC-	DC-
DBR	Dynamic Brake Resistor Connection (-)
U	Motor Output Phase U
V	Motor Output Phase V
W	Motor Output Phase W

**Frames 7 & 8:**

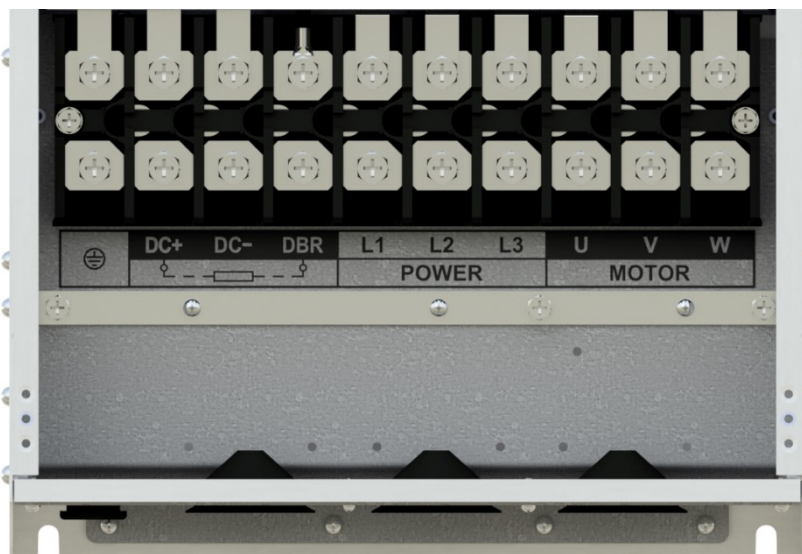

Label	Description
PE	Protective Earth
DC+	DC+ / Dynamic Brake Resistor Connection (+)
DC-	DC-
DBR	Dynamic Brake Resistor Connection (-)
L1	Supply Input Phase L1
L2	Supply Input Phase L2
L3	Supply Input Phase L3
U	Motor Output Phase U
V	Motor Output Phase V
W	Motor Output Phase W

**Frames 9 & 10:**

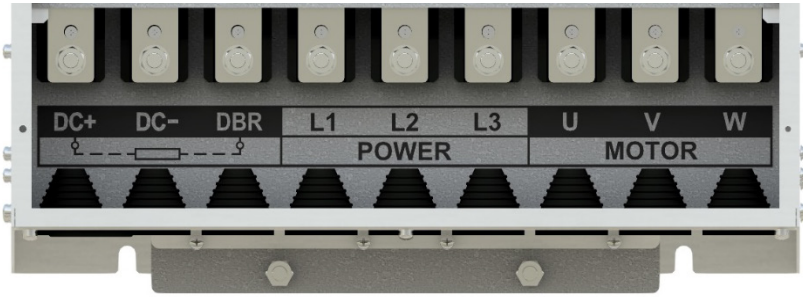

Label	Description
DC+	DC+ / Dynamic Brake Resistor Connection (+)
DC-	DC-
DBR	Dynamic Brake Resistor Connection (-)
L1	Supply Input Phase L1
L2	Supply Input Phase L2
L3	Supply Input Phase L3
U	Motor Output Phase U
V	Motor Output Phase V
W	Motor Output Phase W

**Inverter Connections**

**AC Line Input Connections:**

Incoming AC line supply connections should be wired into terminals:

- L 'Live' & N 'Neutral' on single phase products (20G-12-...)
- L1, L2 & L3 on three phase products (20G-3x-... & 20G-4x-...)

On three phase products, phase rotation is not critical.

**AC Motor Output Connections:**

Output motor supply connections should be wired into terminals U, V & W.

Phase rotation is critical to ensure consistency between the inverter motor control direction and motor shaft rotation.

The motor direction can be inverted electronically by setting the 'IM Wiring' parameter (0182) to 'TRUE'.

This swaps output phases V & W in the drive firmware. Refer to 'Chapter 9: Basic Drive Operation'.

**Potential Earth (PE) Connections:**

Connect both the inverter incoming supply earth cable and motor earth cable to the inverter PE terminals.

**DC Dynamic Brake Output Connections:**

Where a Dynamic Brake Resistor (DBR) is required for an inverter application, connect the resistor across terminals DC+ & DBR.

**Wiring Example**

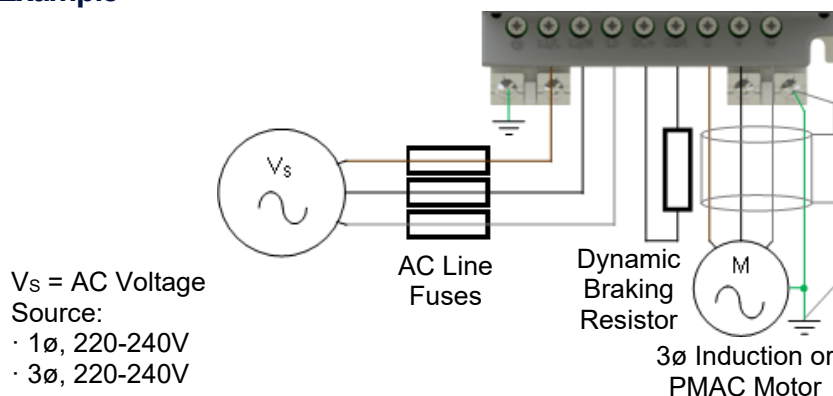

## Lower Terminal Cover Removal (Frames 6 – 10)

On the Frames 6 – 10, the lower terminal cover must be removed to gain access to the power terminals for wiring.

### Frame 6:



1. Remove the two fixing screws from the bottom edge of the lower terminal cover.

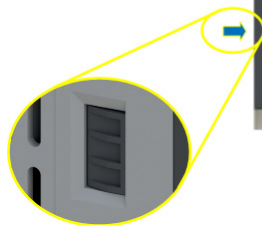

2. Push the two clips in at the sides of the lower cover.
3. With the clips pushed in, push them up towards you to remove the lower panel and access the power terminals.





**Frames 7 – 10:**



1. Unscrew the 2x (Fr 7-9) / 4x (Fr 10) lower panel fixings.



2. Lift the panel away from the product to access the power terminals.





### Terminal Block Guards (Frames 6 – 10)

The Frame 6 – 10 products have an additional protective guard on the power terminal blocks that must be temporarily removed out of the way when wiring the drive.

These guards must be refitted once the power wiring is installed.

#### Frames 6 & 7:

The clear terminal covers unclip and pull away from the terminal block to expose the power terminal connections:



#### Frames 8 – 10:

The clear terminal covers slide upwards from the terminal block to expose the power terminal connections:

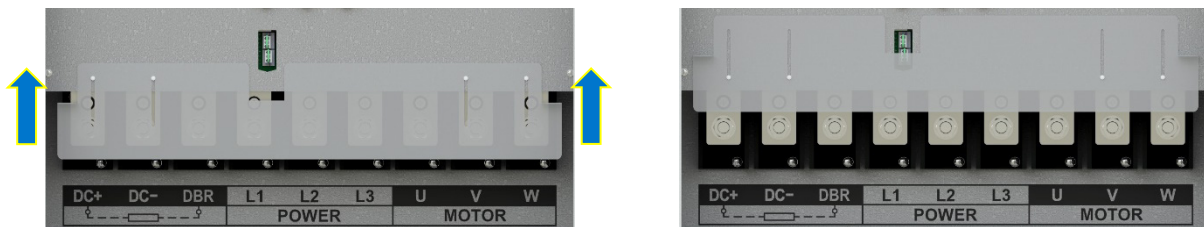

### Terminal Block Wire Range (Europe)

Wire sizes for Europe should be chosen with respect to the inverter operating conditions, in addition to local National Electrical Safety Installation Requirements. Local wiring regulations always take precedence.

#### 230V Products:

Frame Size	AC Line Input Terminals (L1/L, L2/N, L3)	DC Link / Brake Output Terminals (DC+, DC-, DBR)	Motor Output Terminals (U, V, W)	Earth Terminal (PE)	Chassis Earth Clamp (PE)
2	1.5 – 4.0				M4 Fork Crimp
3	4.0 – 10.0				M4 Fork Crimp
4	0.5 – 10.0				M4 Fork Crimp
5	0.5 – 35.0				M4 Fork Crimp

All cable size ranges specified in mm<sup>2</sup>

#### 400V Products:

Frame Size	AC Line Input Terminals (L1/L, L2/N, L3)	DC Link / Brake Output Terminals (DC+, DC-, DBR)	Motor Output Terminals (U, V, W)	Earth Terminal (PE)	Chassis Earth Clamp (PE)
2	1.5 – 4.0				M4 Fork Crimp
3	4.0 – 10.0				M4 Fork Crimp
4	0.5 – 10.0				M4 Fork Crimp
5	0.5 – 35.0				M5 Fork Crimp

All cable size ranges specified in mm<sup>2</sup>

Frame Size	AC Line Input Terminals (L1/L, L2/N, L3)	DC Link / Brake Output Terminals (DC+, DC-, DBR)	Motor Output Terminals (U, V, W)	Earth Terminal (PE)	Chassis Earth Clamp (PE)
6	M8 screw, accepting crimps or lugs up to 20mm wide (Maximum conductor size 25.0mm <sup>2</sup> )				M6 Fork Crimp
7	M8 screw, accepting crimps or lugs up to 25mm wide (Maximum conductor size 95.0mm <sup>2</sup> )				M6 Ring Crimp
8	M10 post, accepting crimps or lugs up to 25mm wide (Maximum conductor size 120.0mm <sup>2</sup> )				M8 Ring Crimp
9	M10 post, accepting crimps or lugs up to 32mm wide (Maximum conductor size 185.0mm <sup>2</sup> )				M10 Ring Crimp
10	M12 post, accepting crimps or lugs up to 41mm wide (Maximum conductor size 240.0mm <sup>2</sup> )				M10 Ring Crimp

### Terminal Block Wire Range (North America)

North American wire sizes (AWG) are based on NEC/NFPA-70 for ampacities of thermoplastic-insulated (75°C) copper conductors.

The wire sizes allow for an ampacity of 125% of the rated input and output amperes for motor branch-circuit conductors as specified in NEC/NFPA-70.

#### 1ø, 230V Products:

Frame Size	Product Code	Motor Power (kW)	AC Line Input Terminals (L1/L, L2/N, L3)	Brake Output Terminals (DC+, DBR)	Motor Output Terminals (U, V, W)
2	Terminal Block Wire Range: 10 – 26 AWG				
	20G-12-0070...	1.5	12	14	14
	20G-12-0100...	2.2	10	14	14

All cable sizes specified in AWG

#### 3ø, 230V Products:

Frame Size	Product Code	Motor Power (kW)	AC Line Input Terminals (L1/L, L2/N, L3)	DC Link / Brake Output Terminals (DC+, DC-, DBR)	Motor Output Terminals (U, V, W)
2	Terminal Block Wire Range: 10 – 26 AWG				
	20G-32-0070...	1.5	14	14	14
	20G-32-0100...	2.2	14	14	14
3	Terminal Block Wire Range: 10 – 20 AWG				
	20G-33-0170...	4.0	10	14	10
4	Terminal Block Wire Range: 6 – 20 AWG				
	20G-34-0210...	5.5	10	14	10
5	Terminal Block Wire Range: 2 – 20 AWG				
	20G-35-0300...	7.5	8	12	8
	20G-35-0400...	11	6	10	8

All cable sizes specified in AWG

**3ø, 400V Products:**

Frame Size	Product Code	Motor Power (kW)	AC Line Input Terminals (L1/L, L2/N, L3)	DC Link / Brake Output Terminals (DC+, DC-, DBR)	Motor Output Terminals (U, V, W)
2	Terminal Block Wire Range: 10 – 30 AWG				
	20G-42-0040...	1.5	14	14	14
	20G-42-0065...	2.2	14	14	14
	20G-42-0090...	4.0	14	14	14
3	Terminal Block Wire Range: 10 – 20 AWG				
	20G-43-0120...	5.5	12	14	14
	20G-43-0170...	7.5	10	14	10
4	Terminal Block Wire Range: 6 – 20 AWG				
	20G-44-0230...	11	10	14	10
	20G-44-0320...	15	8	14	8
5	Terminal Block Wire Range: 2 – 20 AWG				
	20G-45-0380...	18.5	6	10	8
	20G-45-0440...	22	6	10	6
	20G-45-0600...	30	3	10	4
6	Terminal Block Wire Range: 1 – 26 AWG				
	20G-46-0750...	37	3	8	3
	20G-46-0900...	45	1	6	2
7	Terminal Block Wire Range: 4/0 – 20 AWG				
	20G-47-1100...	55	1/0	6	1/0
	20G-47-1500...	75	3/0	4	3/0
8	Busbar:				
	20G-48-1800...	90	250 kcmil	2	4/0
	20G-48-2200...	110	300 kcmil	2	300 kcmil
	20G-48-2650...	132	500 kcmil	2/0	400 kcmil
9	Busbar:				
	20G-49-3200...	160	600 kcmil	4/0	600 kcmil
10	Busbar:				
	20G-410-3600...	180	750 kcmil	250 kcmil	700 kcmil

All cable sizes specified in AWG

**Terminal Block Tightening Torques****230V Products:**

Frame Size	AC Line Input Terminals (L1/L, L2/N, L3)	DC Link / Brake Output Terminals (DC+, DC-, DBR)	Motor Output Terminals (U, V, W)	Earth Terminal (PE)	Chassis Earth Clamp (PE)
2	1.10 (9.0)				1.8 (16.0)
3	1.26 (11.2)				1.8 (16.0)
4	2.15 (19.0)				1.8 (16.0)
5	4.1 (36.5)				1.8 (16.0)

All torques are maximum values specified in Nm (lb-in)

**400V Products:**

Frame Size	AC Line Input Terminals (L1/L, L2/N, L3)	DC Link / Brake Output Terminals (DC+, DC-, DBR)	Motor Output Terminals (U, V, W)	Earth Terminal (PE)	Chassis Earth Clamp (PE)
2		1.13 (10.0)		1.13 (10.0)	1.8 (16.0)
3		1.26 (11.2)		1.26 (11.2)	1.8 (16.0)
4		2.15 (19.0)		2.15 (19.0)	1.8 (16.0)
5		4.10 (36.5)		4.10 (36.5)	3.6 (32.0)
6		2.82 (25.0)		2.82 (25.0)	6.0 (53.0)
7		4.52 (40.0)		4.52 (40.0)	6.0 (53.0)
8		19.5 (173.0)		19.5 (173.0)	11.0 (97.0)
9		19.5 (173.0)		n/a	19.5 (173.0)
10		33.3 (295.0)		n/a	19.5 (173.0)

All torques are maximum values specified in Nm (*lb-in*)

### Cable Connections With Wiring Bracket Fitted (Frames 2 – 5)

Below is an example of how to correctly terminate the motor screen onto the wiring bracket:

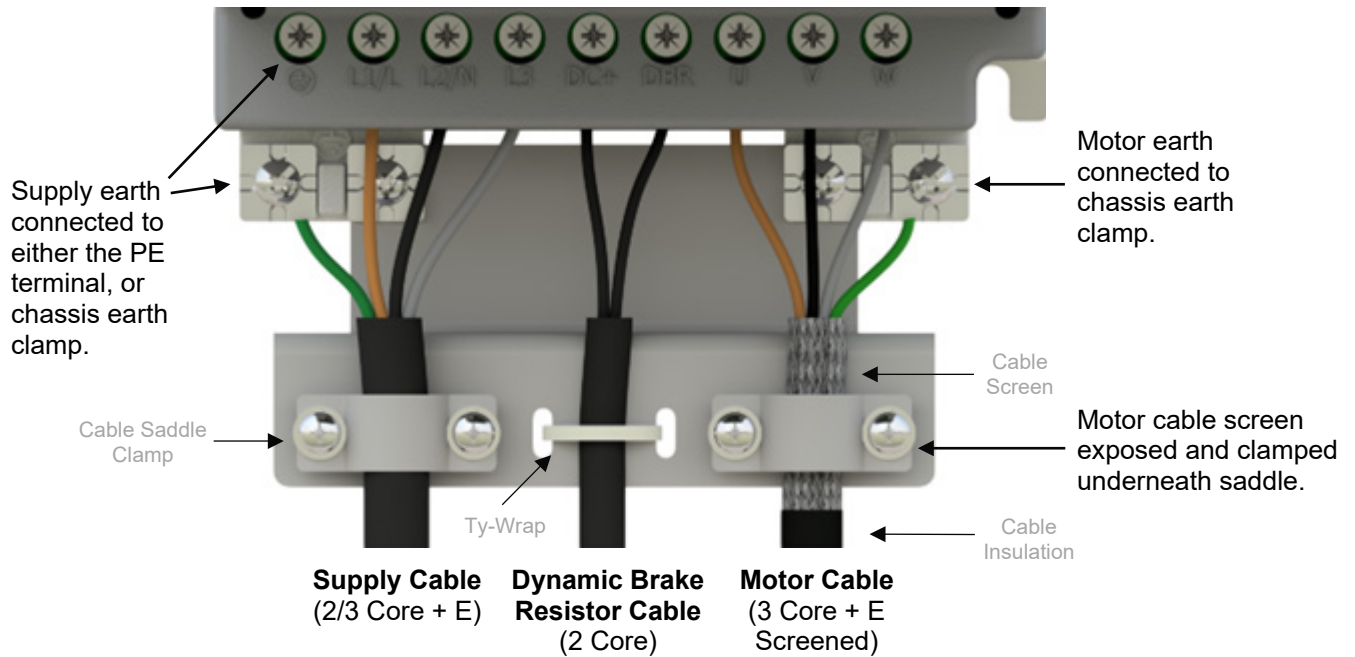

### Cable Glands (Frames 6 – 10)

Rubber / plastic grommets are provided in the gland plates for the AC20 Frames 6 – 10. These should be slit or cut when installing the power cables to the product, so that the cables can be passed through them:

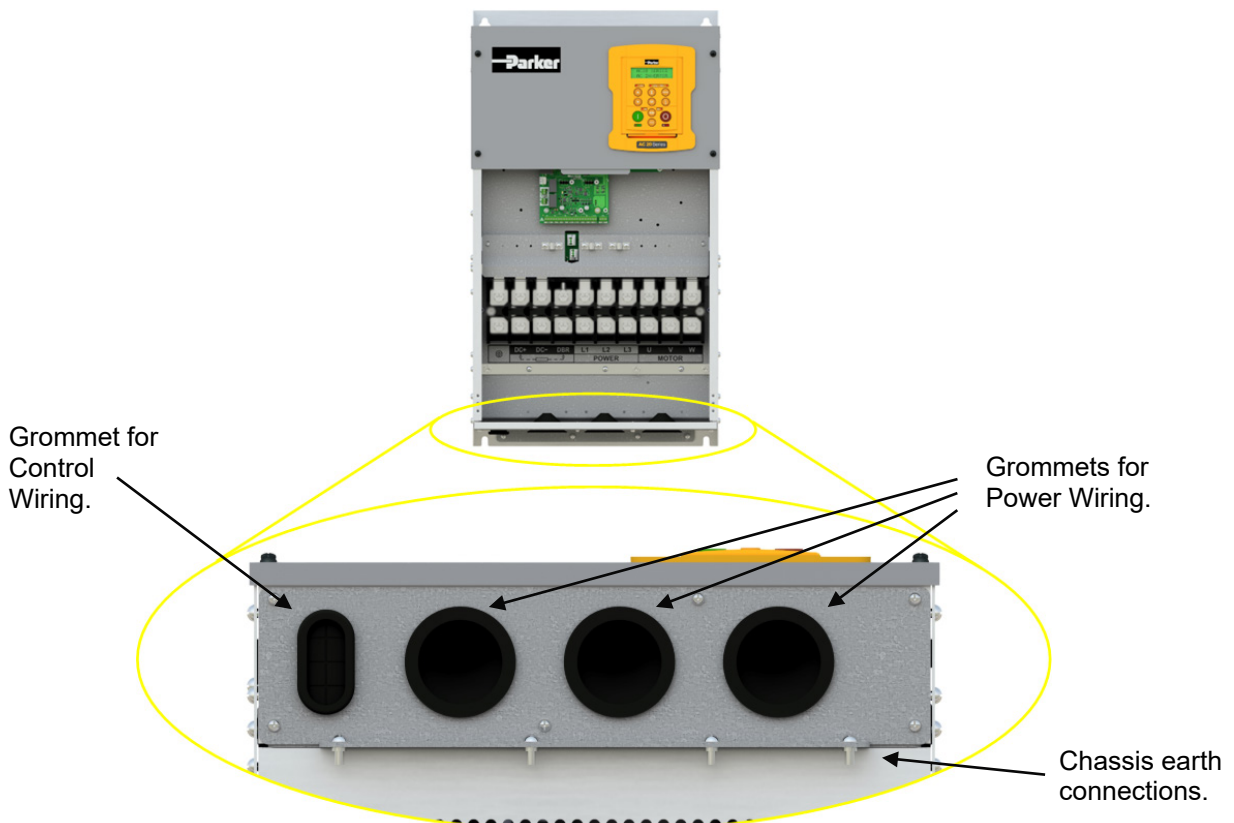

On Frames 7 – 10 where screened cable is used (for example, as recommended for the motor connections), it is recommended that the rubber / plastic grommet is replaced with a metal gland to achieve a full 360° cable screen connection to the chassis.

### Main Duct Fan Supply Voltage Selection (Frames 9 & 10)

When wiring up the drive, the customer must check that the Main Duct Fan supply voltage has been setup for the correct AC Line voltage. This is done by checking the ‘Jumper’ link positions on the Fan Voltage Selection PCB:



1. Unscrew the 4x upper panel fixings.

2. Slide the upper panel up to expose and access the Fan Supply Voltage Selection PCB ‘Jumper’ links.  
**Note: The MMI mounted on the upper panel is plugged into the control board, so be careful when handling the upper panel.**

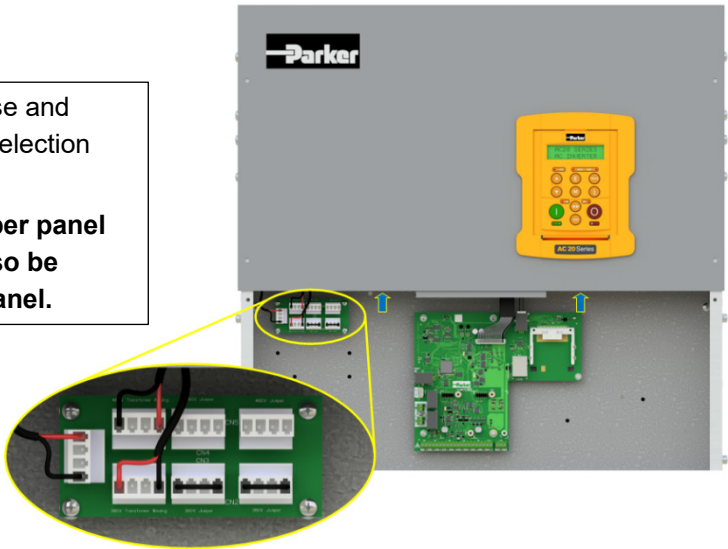

By default, the fan supply jumper links are fitted in the “380V Jumper” positions as shown in the image above.

For 480V line supplies, the links should be moved from CN2 & CN3, to the “480V Jumper” positions CN4 & CN5 as shown below:

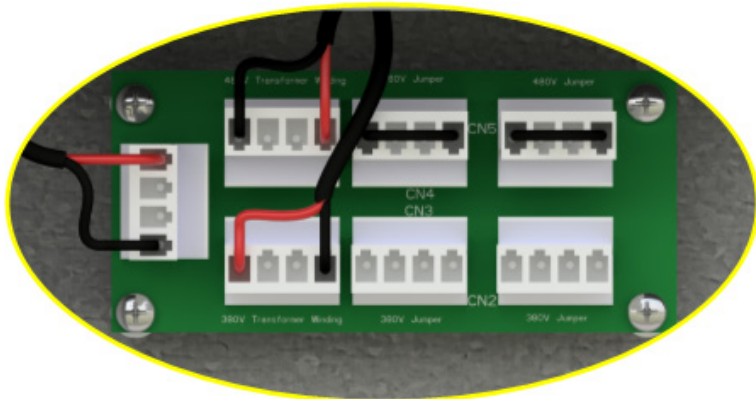

## Y-Capacitors & VDR Earth Disconnects

The AC20 products are fitted with EMC filter capacitors connected between 'live' AC Line (and in some instances DC Link) circuits to earth. These capacitors are referred to as Y-Capacitors.

In some system applications where RCD's are in circuit, or where the drive is connected on an IT or open delta supply, these Y-Capacitors may need to be disconnected from earth. Removable links are provided to enable users to perform this task.

By default:

- AC Line Y-Caps are connected to earth ('EMC' connector 'J1', is fitted in position 1 - 3).
- DC Link Y-Caps are connected to earth ('P -> PE' connector 'J2' is fitted in position 1 - 3).

Most products are also fitted with input line voltage suppression devices connected between 'live' AC Line circuits to earth. These suppression devices are referred to as VDRs.

In some system applications where the product is exposed to large, transient voltage events on the power supply that it is connected to, it is recommended that the VDRs are connected to earth as a means of protecting the drives input rectification stage. Removable links are provided to enable users to perform this task.

By default:

- VDRs are **NOT** connected to earth ('VAR' connector 'Y1', is fitted in position 2 - 4).

A summary of links fitted to each product is shown below:

### 1 $\phi$ , 230V Products:

Frame Size	Product Code	Motor Power (kW)	J1 'EMC' (AC Line Y-Cap) Link:	Y1 'VAR' (VDR) Link:	J2 'P -> PE' (DC Link Y-Cap) Link:
2	20G-12-0070...	1.5	✓	✗	✗
	20G-12-0100...	2.2	✓	✗	✗

### 3 $\phi$ , 230V Products:

Frame Size	Product Code	Motor Power (kW)	J1 'EMC' (AC Line Y-Cap) Link:	Y1 'VAR' (VDR) Link:	J2 'P -> PE' (DC Link Y-Cap) Link:
2	20G-32-0070...	1.5	✓	✓	✗
	20G-32-0100...	2.2	✓	✓	✗
3	20G-33-0170...	4.0	✓	✗	✓
4	20G-34-0210...	5.5	✓	✗	✗
5	20G-35-0300...	7.5	✓	✗	✗
	20G-35-0400...	11	✓	✗	✗



**3ø, 400V Products:**

Frame Size	Product Code	Motor Power (kW)	J1 'EMC' (AC Line Y-Cap) Link:	Y1 'VAR' (VDR) Link:	CN5 'P -> PE' (DC Link Y-Cap) Link:
2	20G-42-0040...	1.5	✓	✓	✗
	20G-42-0065...	2.2	✓	✓	✗
	20G-42-0090...	4.0	✓	✓	✗
3	20G-43-0120...	5.5	✓	✓	✗
	20G-43-0170...	7.5	✓	✓	✗
4	20G-44-0230...	11	✓	✓	✗
	20G-44-0320...	15	✓	✓	✗
5	20G-45-0380...	18.5	✓	✓	✗
	20G-45-0440...	22	✓	✓	✗
	20G-45-0600...	30	✓	✓	✗
6	20G-46-0750...	37	✓	✓	✗
	20G-46-0900...	45	✓	✓	✗
7	20G-47-1100...	55	✓	✓	✓
	20G-47-1500...	75	✓	✓	✓
8	20G-48-1800...	90	✓	✓	✓
	20G-48-2200...	110	✓	✓	✓
	20G-48-2650...	132	✓	✓	✓
9	20G-49-3200...	160	✓	✓	✗
10	20G-410-3600...	180	✓	✓	✗

**Approximate Link Locations:**

Note: Link positions vary slightly between products. Images show approximate link locations:

Frames 2 - 5:

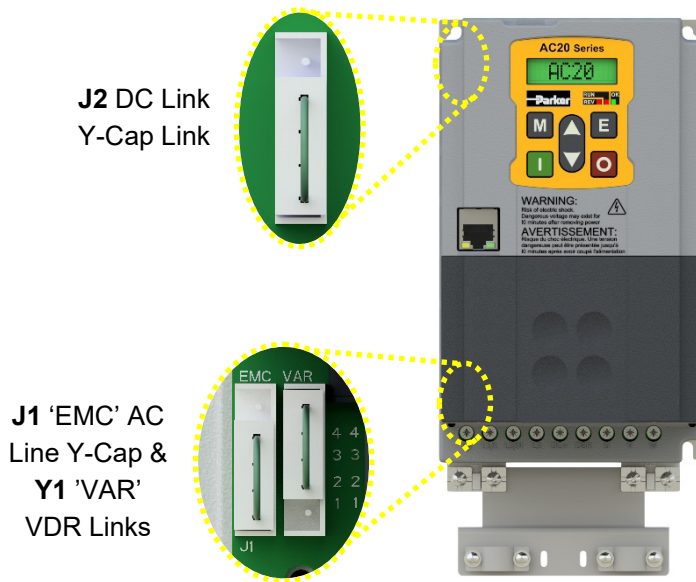

To access the links, it is necessary to open the product:

1. Remove the 4x Power Stack cover fixings (2x top, 2x bottom of product).
2. Carefully lift the power stack cover with the control module attached - just enough to adjust the link positions. Removing the link completely is the same as placing the links in the 'disconnected' (pin 2 – 4) position.

**Note: All power cables must be removed from the product to access the links.**

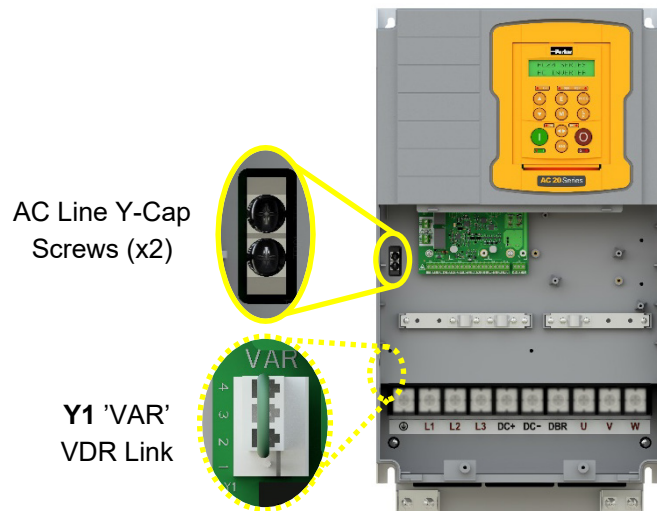

Frame 6:

To access the **Y-Cap** links:

1. Remove the Lower Terminal cover.
2. Remove the 2x screws from the product.

To access the **VDR** link, it is necessary to open the product:

1. Remove the Lower Terminal cover.
2. Carefully remove the Upper Terminal cover, disconnecting the onboard keypad cable from the top of the control board.
3. Remove the 4x plastic moulding fixings screws from the four corners of the product.
4. Carefully lift the power stack cover with the control board attached - just enough to adjust the link position.

**Note: All power cables must be removed from the product to access this link.**

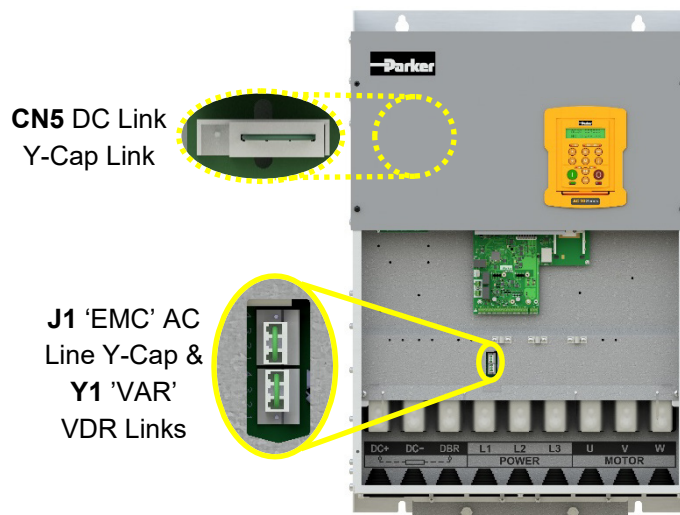
Frames 7 – 10:

To access the **AC Line Y-Cap & VDR** links:

1. Remove the Lower Terminal cover.
2. Adjust the link positions. Removing the link completely is the same as placing the links in the 'disconnected' (pin 2 – 4) position.

To access the **DC Link Y-Cap** link:

1. Remove the Lower Terminal cover.
2. Carefully remove the Upper Terminal cover, disconnecting the onboard keypad cable from the top of the control board.
3. Adjust the link position of CN5. Removing the link completely is the same as placing the link in the 'disconnected' (pin 2 – 4) position.

## 6.2.2 Control Board Wiring

**DANGER!**  
**RISK OF ELECTRIC SHOCK**



Terminal covers, main covers, and cover fixings must remain in place while the drive is energised.

These should only ever be removed once the supply to the unit and/or system has been disconnected, and the residual energy in the DC link capacitors has been discharged.



### Terminal Cover Removal (Frames 2 – 5 only)

On the Frames 2 – 5, the control module terminal cover must be removed to gain access to the control terminals for wiring.



1. Apply pressure to the center of the top edge of the terminal cover to disengage the retention clip.



2. Now slide the cover down and pull away from the control module.



To refit the terminal cover, perform the steps in reverse.

On the Frames 6 – 10, the removal of the lower terminal cover, required to access the power terminals, allows access to the control terminals for wiring.

## Terminal Identifications

Frames 2 – 5:

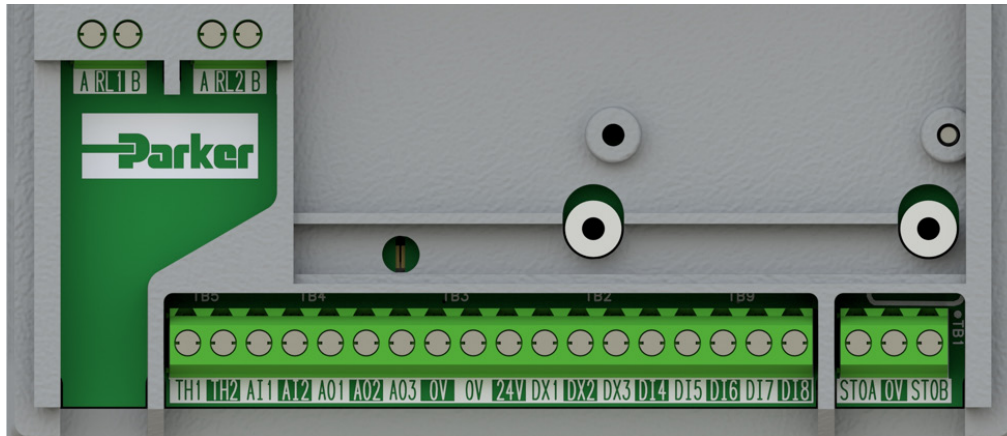

Terminal Ident	Description
RL1A	Relay Output 1 (Contact A)
RL1B	Relay Output 1 (Contact B)
RL2A	Relay Output 2 (Contact A)
RL2B	Relay Output 2 (Contact B)
TH1	Motor Thermistor Input
TH2	Motor Thermistor Input
AI1	Analogue Input 1 ( $\pm 10V$ , 0-10V, 0-20mA, 4-20mA)
AI2	Analogue Input 2 ( $\pm 10V$ , 0-10V, 0-20mA, 4-20mA)
AO1	Analogue Output 1 (0-10V, 0-20mA, 4-20mA)
AO2	Analogue Output 2 (0-10V, 0-20mA, 4-20mA)
AO3	Analogue Output 3 ( $\pm 10V$ , 0-10V)
0V	0V Reference For Analogue & Digital I/O
0V	0V Reference For Analogue & Digital I/O / External 0V Auxiliary Input
24V	User +24V Output / External +24V Auxiliary Input
DX1	Digital Input / Output 1 (24V Configurable)
DX2	Digital Input / Output 2 (24V Configurable)
DX3	Digital Input / Output 3 (24V Configurable)
DI4	Digital Input 4
DI5	Digital Input 5
DI6	Digital Input 6
DI7	Digital Input 7
DI8	Digital Input 8
STOA	STO Input Channel A
0V	STO 0V Reference
STOB	STO Input Channel B

Frames 6 – 10:

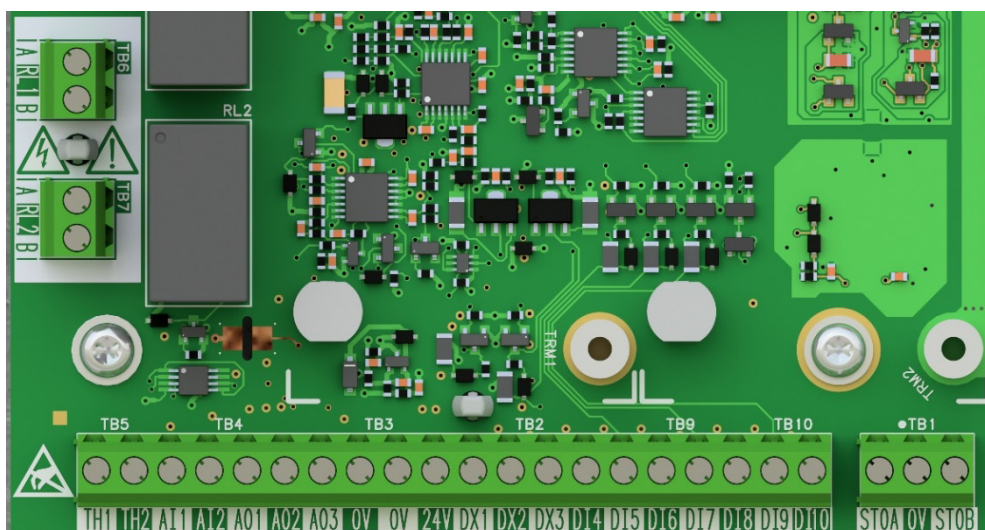

Terminal Ident	Description
RL1A	Relay Output 1 (Contact A)
RL1B	Relay Output 1 (Contact B)
RL2A	Relay Output 2 (Contact A)
RL2B	Relay Output 2 (Contact B)
TH1	Motor Thermistor Input
TH2	Motor Thermistor Input
AI1	Analogue Input 1 ( $\pm 10V$ , 0-10V, 0-20mA, 4-20mA)
AI2	Analogue Input 2 ( $\pm 10V$ , 0-10V, 0-20mA, 4-20mA)
AO1	Analogue Output 1 (0-10V, 0-20mA, 4-20mA)
AO2	Analogue Output 2 (0-10V, 0-20mA, 4-20mA)
AO3	Analogue Output 3 ( $\pm 10V$ , 0-10V)
0V	0V Reference For Analogue & Digital I/O
0V	0V Reference For Analogue & Digital I/O / External 0V Auxiliary Input
24V	User +24V Output / External +24V Auxiliary Input
DX1	Digital Input / Output 1 (24V Configurable)
DX2	Digital Input / Output 2 (24V Configurable)
DX3	Digital Input / Output 3 (24V Configurable)
DI4	Digital Input 4
DI5	Digital Input 5
DI6	Digital Input 6
DI7	Digital Input 7
DI8	Digital Input 8
DI9	Digital Input 9
DI10	Digital Input 10
STOA	STO Input Channel A
0V	STO 0V Reference
STOB	STO Input Channel B

## Wiring Example

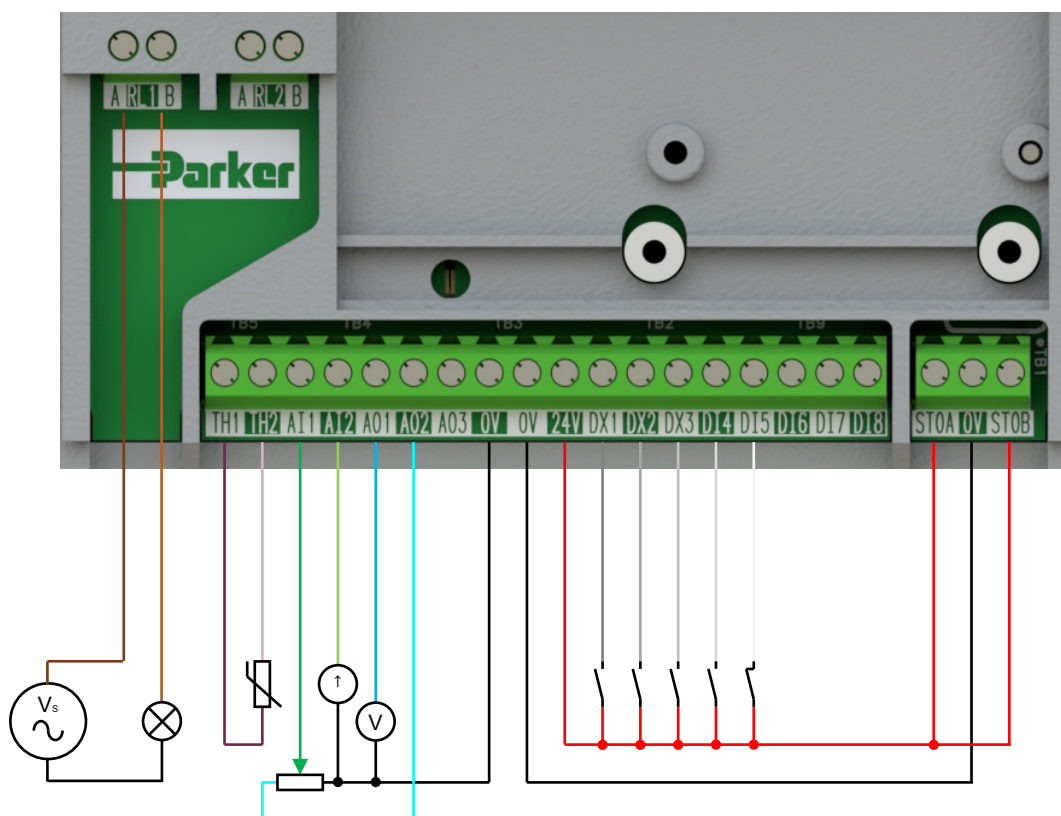

### Configuration Setup:

RL1A	110-230Vac (or 24Vdc) voltage supply.
RL1B	Relay output (to lamp).
TH1	Motor Thermistor '+' connection.
TH2	Motor Thermistor '-' connection.
AI1	0-10V variable input (from potentiometer)
AI2	4-20mA variable input (from current source)
AO1	0-10V variable output (to voltmeter)
AO2	0-10V variable output (+10V fixed reference voltage)
DX1	24V digital input
DX2	24V digital input
DX3	24V digital input
DI4	24V digital input
DI5	24V digital input
STO	STO <b>DISABLED</b> (drive operational)

### Terminal Block Wire Range

The control board terminal wire range is as follows:

Terminal Wire Range	
Min	Max
0.2mm <sup>2</sup> (24 AWG)	1.0mm <sup>2</sup> (18 AWG)

Wire sizes for Europe should be chosen with respect to the operating conditions and your local National Electrical Safety Installation Requirements. Local wiring regulations always take precedence.





## 6.2.3 Control Board Communications Wiring

The Ethernet communications socket allows users to:

- Communicate over Ethernet IP, Modbus TCP/IP, or ProfinetIO.
- Access the drive's Web Server.
- Connect to the Drive System Explorer (DSE Lite) software for function block programming of custom applications and firmware updates, etc.

### Recommended Ethernet Cables

The following Ethernet cables are recommended for connecting to the control board RJ45 socket:

Ethernet Cable Category	Screened / Unscreened
CAT5e	Screened
CAT6	Screened

### Cable Connection

#### Frames 2 – 5:

On Frames 2 – 5, the Ethernet cable plugs into the RJ45 socket on the front of the product:



To remove the cable, push the connector clip up towards the cable and pull away from the product.

#### Frames 6 – 10:

On Frames 6 – 10, the lower terminal cover will need to be removed prior to connecting the Ethernet cable into the RJ45 socket on the control PCB.

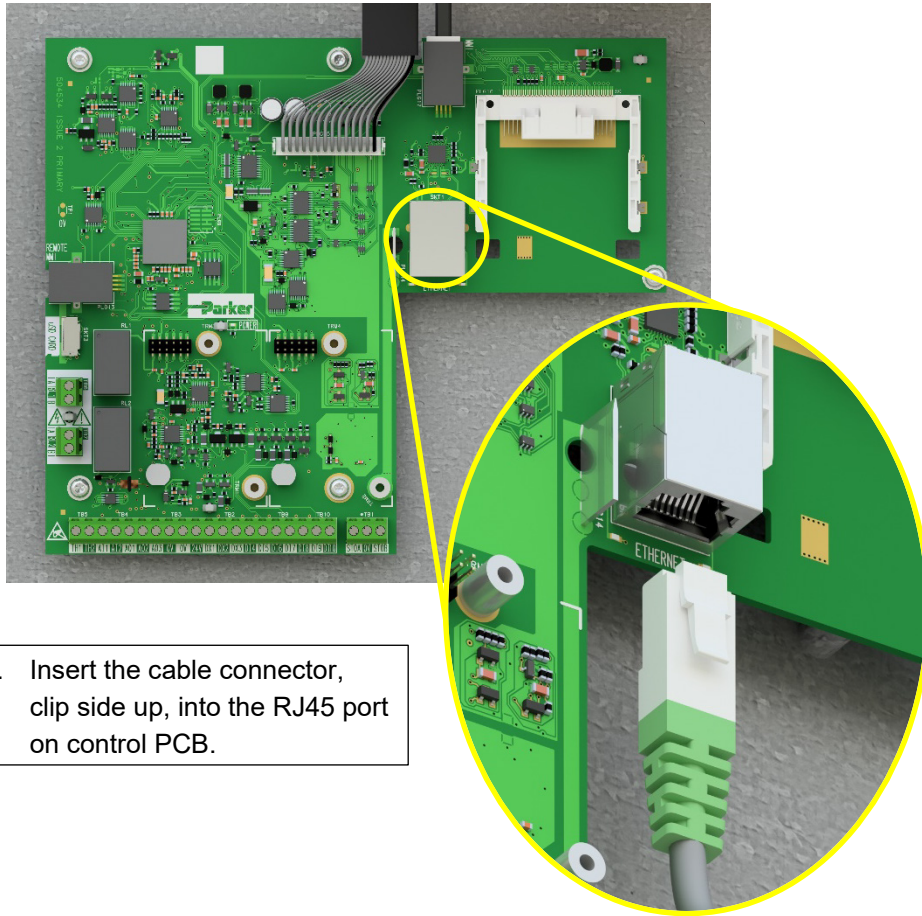

1. Insert the cable connector, clip side up, into the RJ45 port on control PCB.

To remove the cable, push the connector clip down towards the cable and pull.



## 6.3 Option Cards

Two types of Option Card are available, providing additional product functionality.

### 6.3.1 Order Codes

Order Code	Description
2004-IO-00	General Purpose Input/Output (GPIO) option card
2004-EN-00	Encoder Feedback option card

### 6.3.2 Installation

**DANGER!**  
**RISK OF ELECTRIC SHOCK**



Terminal covers, main covers, and cover fixings must remain in place while the drive is energised.

These should only ever be removed once the supply to the unit and/or system has been disconnected, and the residual energy in the DC link capacitors has been discharged.



**CAUTION!**  
**ESD SENSITIVE EQUIPMENT**



Take ESD precautions when handling the Option Cards to avoid any risk of damaging the equipment.



The Option Cards are intended to be customer installed.

The Option Cards can be fitted to either Slot 1 or 2, and either two different or two identical Option Cards can be fitted simultaneously if required.

**Note:** Do **NOT** install the Option Card with power applied to the product, as damage may occur.

#### Frames 2 – 5:

On the Frames 2 – 5, the control module terminal cover will need to be removed prior to option card installation.

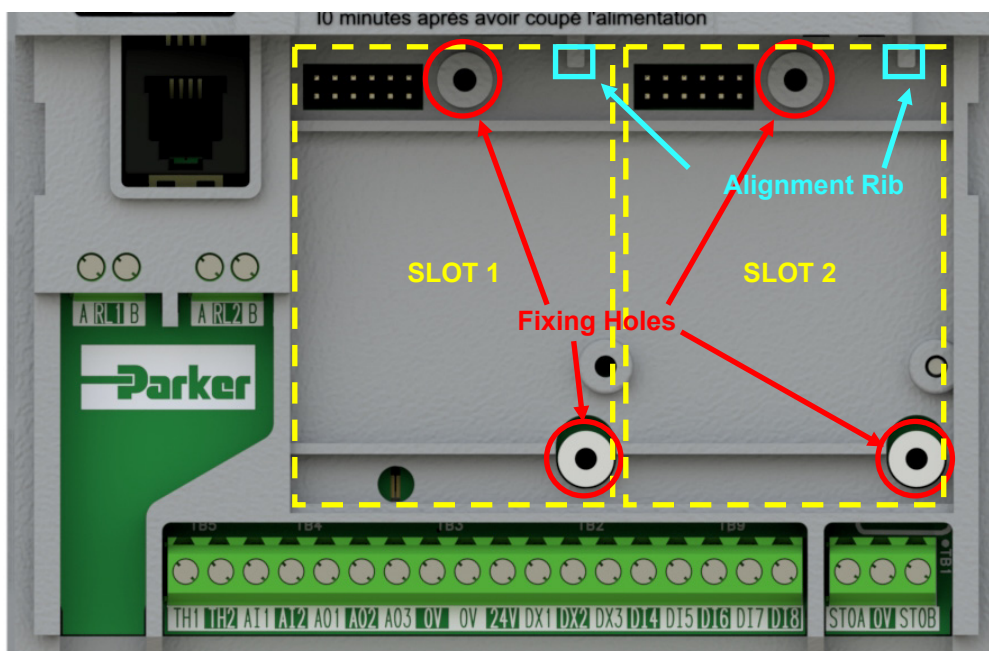

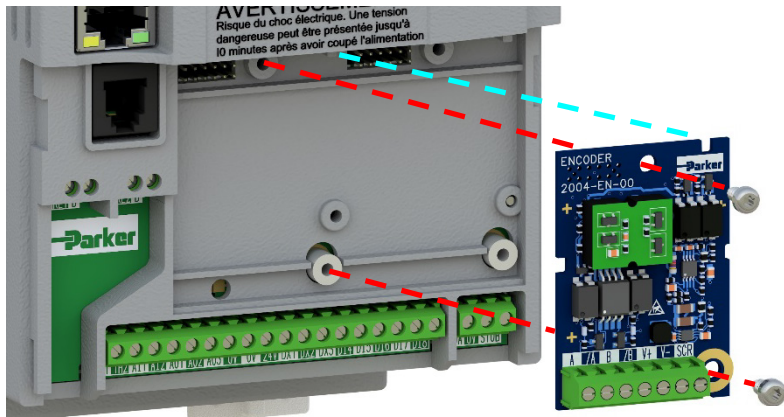

1. Remove the option card from its packaging.
  2. Use the alignment rib in the control module housing and the option card fixing positions to correctly align the option card connector onto the control board header.
- When aligned, push the Option Card down.

3. Screw 1x 130-502020 (M3x8 fixing) into the bottom mounting pillar.
4. Screw 1x 130-502040 (3x7 self-tap fixing) into the top moulding pillar.

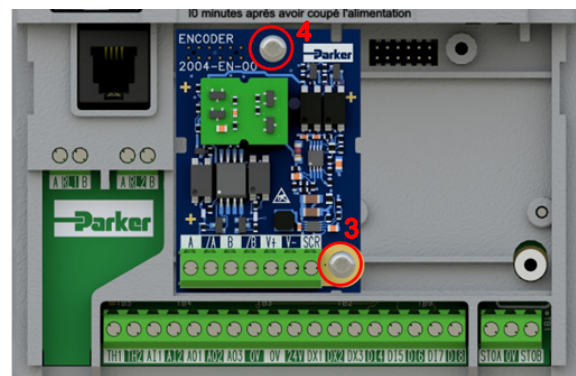

If an Option Card needs to be removed, unscrew the two fixings and insert a screwdriver into the notches on the sides of the PCB to carefully lever the PCB out of the control module housing.

**Frames 6 – 10:**

On Frames 6 – 10, the lower terminal cover will need to be removed prior to option card installation.

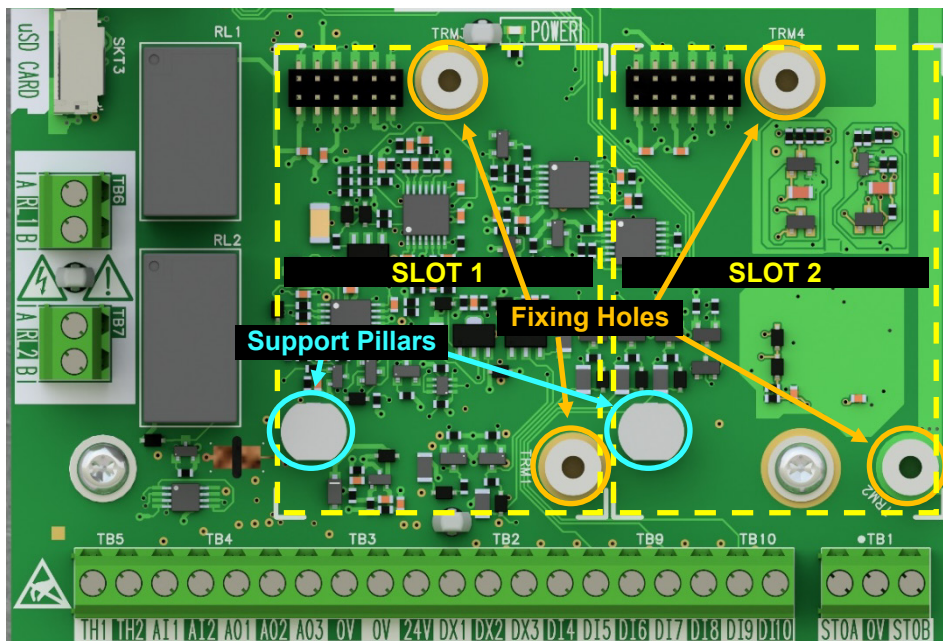

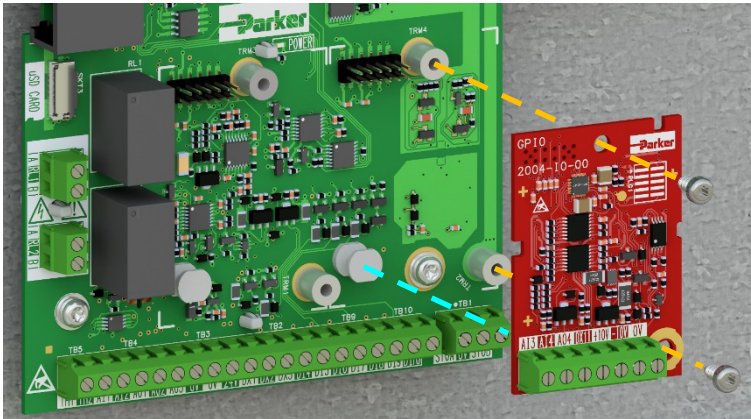

1. Remove the option card from its packaging.
  2. Use the option card fixing positions to correctly align the option card connector onto the control board header.
- When aligned, push the Option Card down until it rests on the fixing and support pillars.

3. Screw 2x 130-502020 (M3x8 fixings) into the top and bottom mounting pillars.

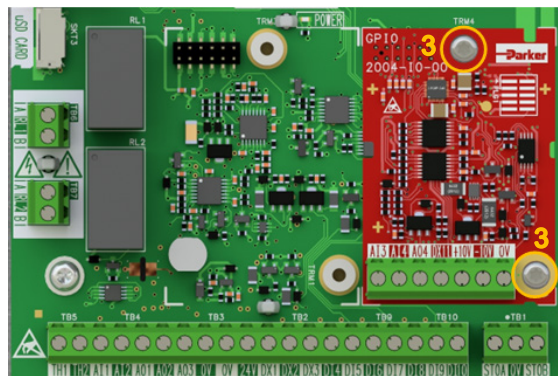

If an Option Card needs to be removed, unscrew the two fixings and carefully pull on the top and bottom edges of the PCB away from the control PCB.

### 6.3.3 Wiring

#### Terminal Identification

#### Encoder Feedback:

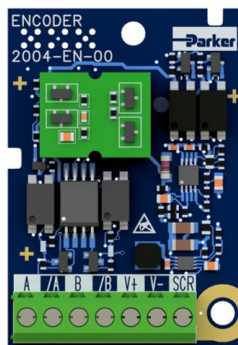

Terminal Ident	Firmware Identification		Description
	Slot 1	Slot 2	
A	Encoder A	Encoder 2 A	Encoder 1 / 2: Channel A Input
/A	Encoder /A	Encoder 2 /A	Encoder 1 / 2: Channel /A Input
B	Encoder B	Encoder 2 B	Encoder 1 / 2: Channel B Input
/B	Encoder /B	Encoder 2 /B	Encoder 1 / 2: Channel /B Input
V+	Encoder V+	Encoder 2 V+	Encoder 1 / 2: Encoder Supply + (5V, 12V, 15V or 20V)
V-	Encoder V-	Encoder 2 V-	Encoder 1 / 2: Encoder Supply – (0V)
SCR	Encoder SCR	Encoder 2 SCR	Encoder 1 / 2: Cable Screen

**General Purpose Input / Output (GPIO):**



Terminal Ident	Firmware Identification		Description
	Slot 1	Slot 2	
AI3	Anin 3	Anin 5	Analogue Input 3 / 5 ( $\pm 10V$ , 0-10V)
AI4	Anin 4	Anin 6	Analogue Input 4 / 6 ( $\pm 10V$ , 0-10V)
AO4	Anout 4	Anout 5	Analogue Output 4 / 5 ( $\pm 10V$ , 0-10V)
DX11	Digin / Digout 11	Digin / Digout 12	Digital Input / Output 11 / 12 (24V Configurable)
+10V	+10V	+10V	+10V Reference Voltage
-10V	-10V	-10V	-10V Reference Voltage
0V	0V	0V	0V Reference For Analogue & Digital I/O

**Wiring Example**

**Encoder Feedback:**

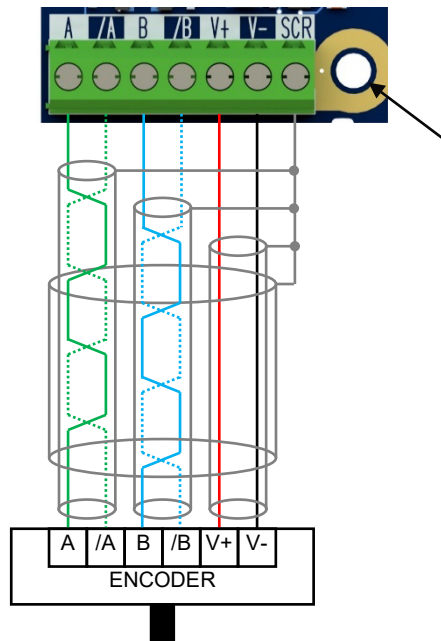

Cable screens may also be terminated at the option card lower fixing point, using either an M3 fork or ring crimp.

**Note:** The 'SCR' screen terminal is internally connected to the drive chassis (PE).



**GPIO:**

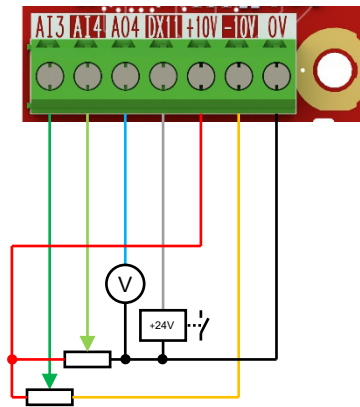

Configuration Example:	
AI3	±10V Variable Input (from potentiometer)
AI4	0-10V Variable Input (from potentiometer)
AO4	0-10V Variable Output (to voltmeter)
DX11	+24V Output (to relay coil)

**Terminal Block Wire Range**

The control board terminal wire range is as follows:

Terminal Wire Range	
Min	Max
0.2mm <sup>2</sup> (24 AWG)	1.0mm <sup>2</sup> (18 AWG)

Wire sizes for Europe should be chosen with respect to the operating conditions and your local National Electrical Safety Installation Requirements. Local wiring regulations always take precedence.

**Recommended Wire & Ferrule Sizes**

The following wire sizes and ferrules are recommended for use with the control board terminal blocks:

Wire Type	Maximum Wire Size	Ferrule Details	Bare Wire / Ferrule Length
Stranded	1x 1.0mm <sup>2</sup> (1x 18 AWG)	None Fitted	5mm (0.20")
	2x 0.5mm <sup>2</sup> (2x 21 AWG)	None Fitted	
Stranded	1x 0.75mm <sup>2</sup> (1x 19 AWG)	White Collar, 1.5mm OD	6mm (0.24")
	1x 0.5mm <sup>2</sup> (1x 21AWG)	Orange Collar, 1.3mm OD	

**Terminal Block Tightening Torque**

The control board terminals should be screwed to a maximum torque as specified below:

Screw Head	Terminal Tightening Torque
M2, Flat	0.19 Nm (1.7 Lb-in)

## 6.4 Communication Interface Option Cards

Communication Interface Option Cards are available to customers, providing a wider range of product compatible communication interfaces to end applications.

### 6.4.1 Order Codes

Order Code	Description
2003-CB-00	CANopen communication interface option card
2003-EC-00	EtherCAT communication interface option card
2003-IP-00	Ethernet IP communication interface option card
2003-PB-00	Profibus DP-V1 communication interface option card
2003-PN-00	Profinet IO communication interface option card
2003-RS-00	RS485 Modbus RTU communication interface option card

### 6.4.2 Installation

**DANGER!**  
**RISK OF ELECTRIC SHOCK**



Terminal covers, main covers, and cover fixings must remain in place while the drive is energised.

These should only ever be removed once the supply to the unit and/or system has been disconnected, and the residual energy in the DC link capacitors has been discharged.



**CAUTION!**  
**ESD SENSITIVE EQUIPMENT**



Take ESD precautions when handling the Communication Interface Option Cards to avoid any risk of damaging the equipment.



The Communication Interface Option Cards are intended to be customer installed.

**Note: Do NOT install the Comms Option with power applied to the product, as damage may occur.**

#### Frames 2 – 5:

On the Frames 2 – 5, the control module housing will need to be removed prior to option card installation.

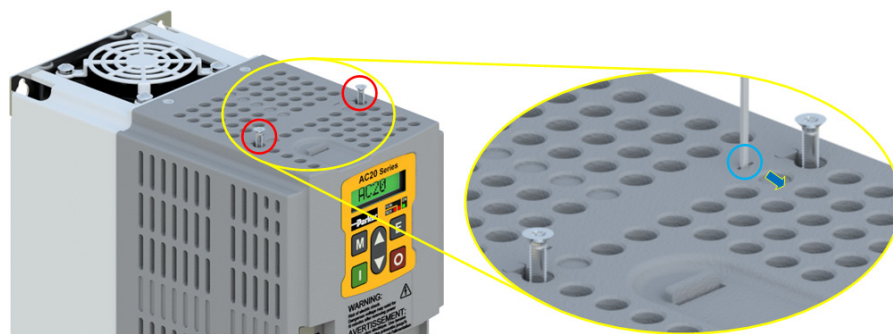

1. Use a T9 TORX driver to partially unscrew the two 3x12 countersunk fixings along the top of the product.
2. Insert a flat head screwdriver into the moulding features and lever the control module housing away from the power stack.

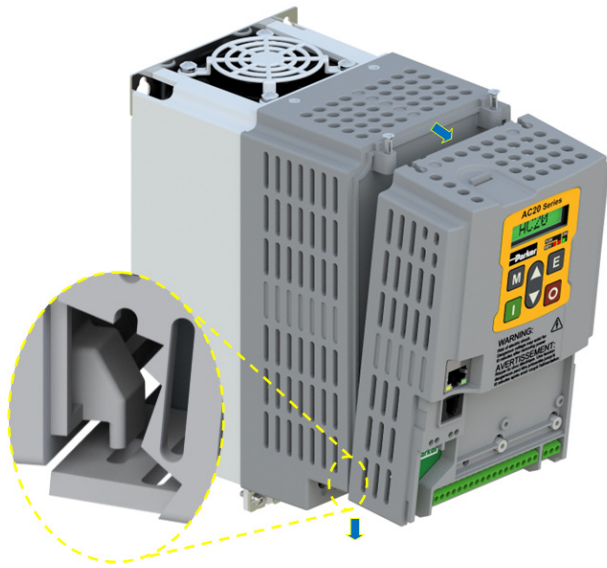

3. Unhook the bottom of the control module housing from the power stack.
4. Gently turn the control module upside down so it rests to the right of the power stack, with the interface cables still connected.

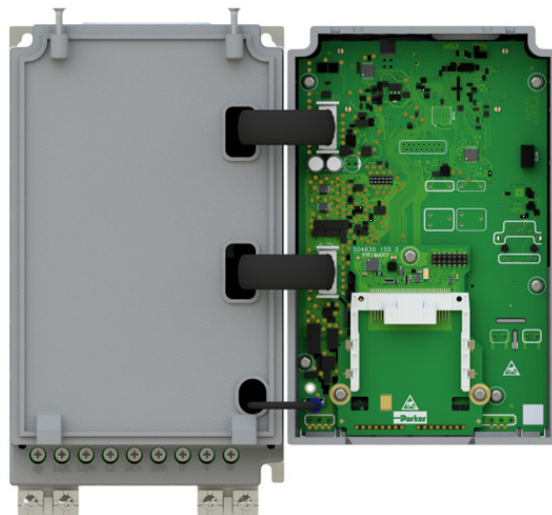

5. Remove and discard the Comms Option break-out feature in the control module housing by cutting the 7x bridges using suitable small side cutters.

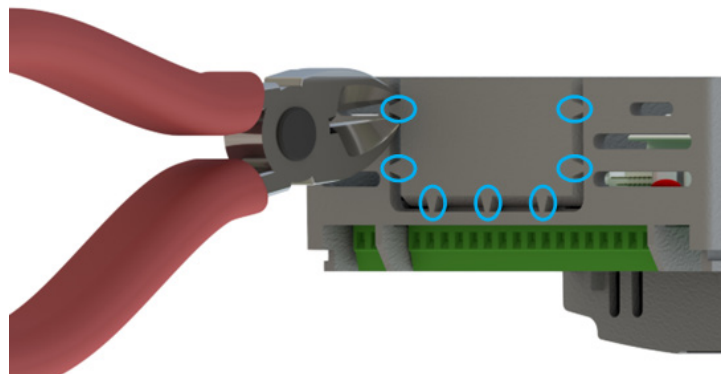

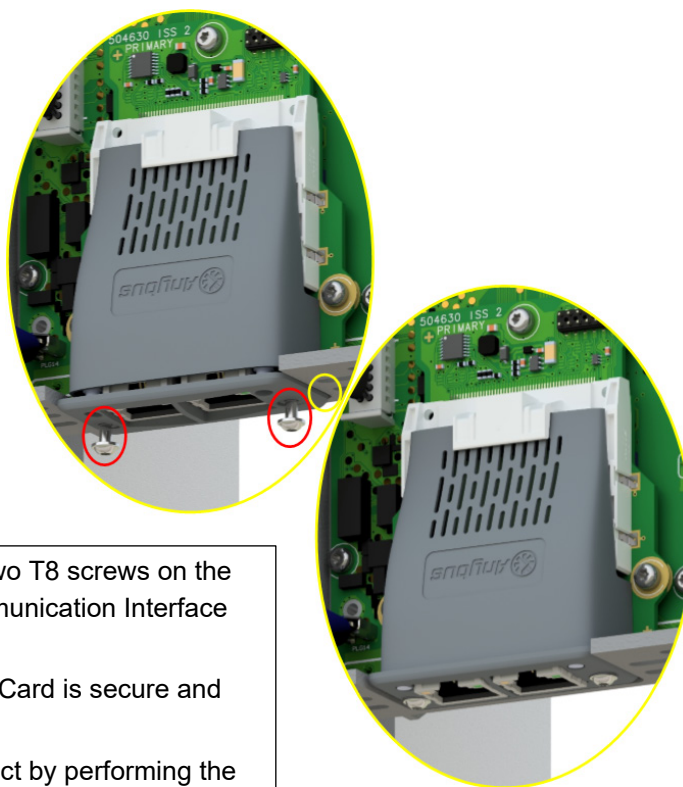
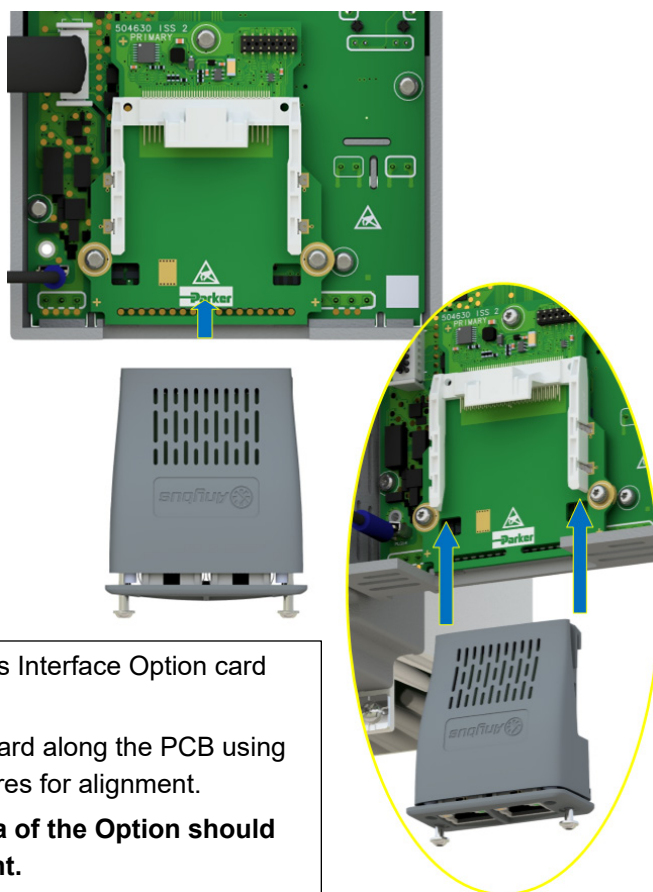

If the Communication Interface Option Card needs to be removed, perform steps 7 & 8 in reverse.



**Frames 6 – 10:**

On Frames 6 – 10, the lower terminal cover will need to be removed prior to option card installation.

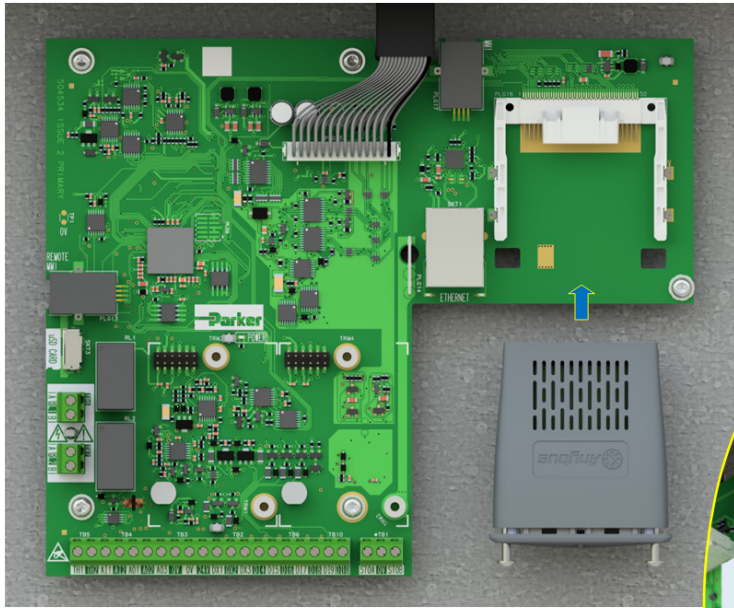

1. Remove the Comms Interface Option card from its packaging.
2. Slide the Comms Card along the PCB using the connector features for alignment.

**Note: The front facia of the Option should be loose at this point.**

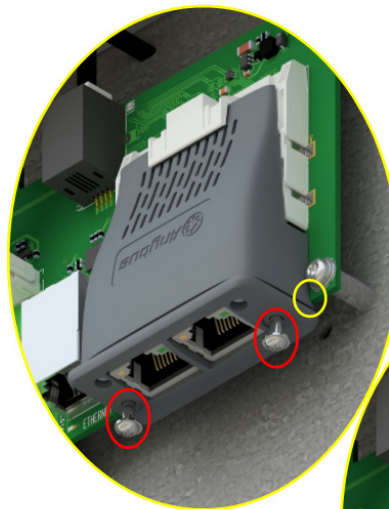
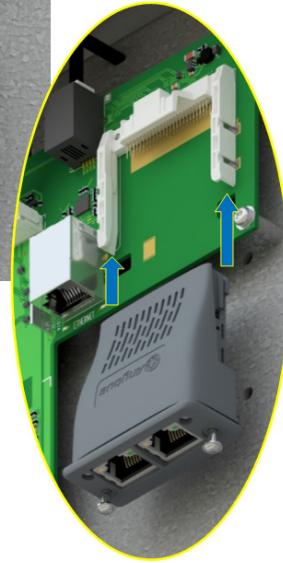

3. When the Comms Interface Option Card is fully engaged in the connector and its housing has hocked onto the edge of the PCB, fully tighten the two T8 screws on the front facia.
4. Check that the Option Card is secure and that it cannot slide out.

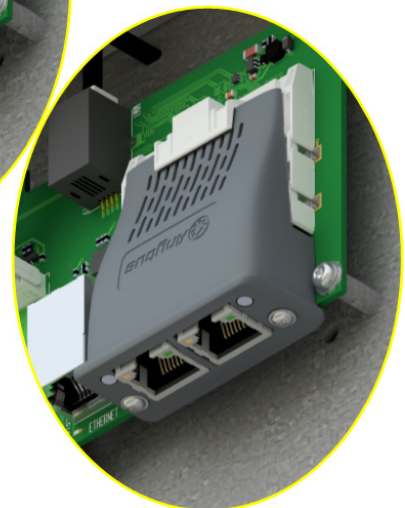

If the Communication Interface Option Card needs to be removed, perform steps 2 & 3 in reverse.

## 6.5 µSD Memory Card

Commercially available µSD Memory Cards may be fitted to allow users to:

- Clone drive applications and archive files for duplication or copying to a replacement unit.
- Provide a quick and easy means of updating the drive firmware in the field.

**Note: The µSD card must be FAT32 formatted. This implies a 32GB limitation of MS Windows OS. If a different type of µSD card is used, then a partition tool may be required.**

### 6.5.1 Installation



**WARNING!**  
**RISK OF DATA CORRUPTION**

Do not remove the µSD card when reading or writing to the memory storage device. This could cause irreversible data corruption.



The µSD Memory Card is intended to be customer installed.

#### Frames 2 – 5:

On Frames 2 – 5, it is inserted in a slot on the top of the product:

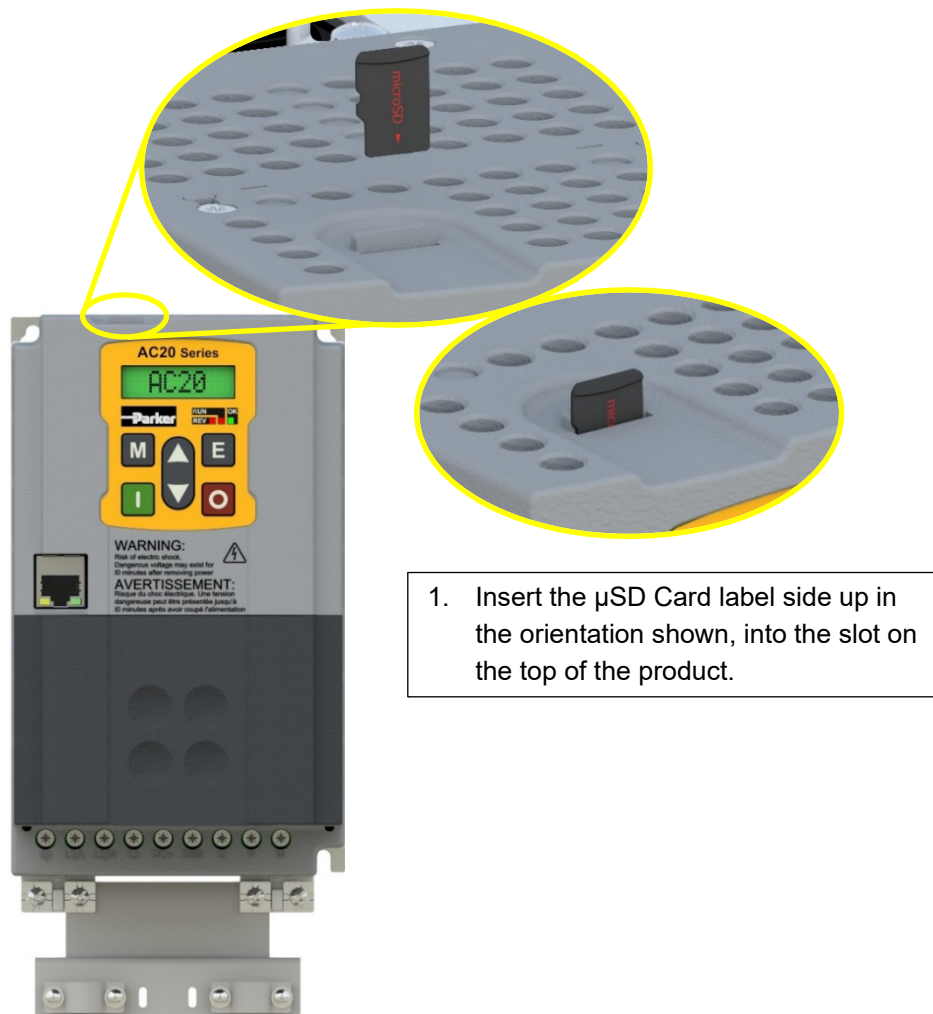

To remove the card, pull it up out of the slot.

**Frames 6 – 10:**

On Frames 6 – 10, the lower terminal cover will need to be removed prior to  $\mu$ SD card installation in the control PCB.

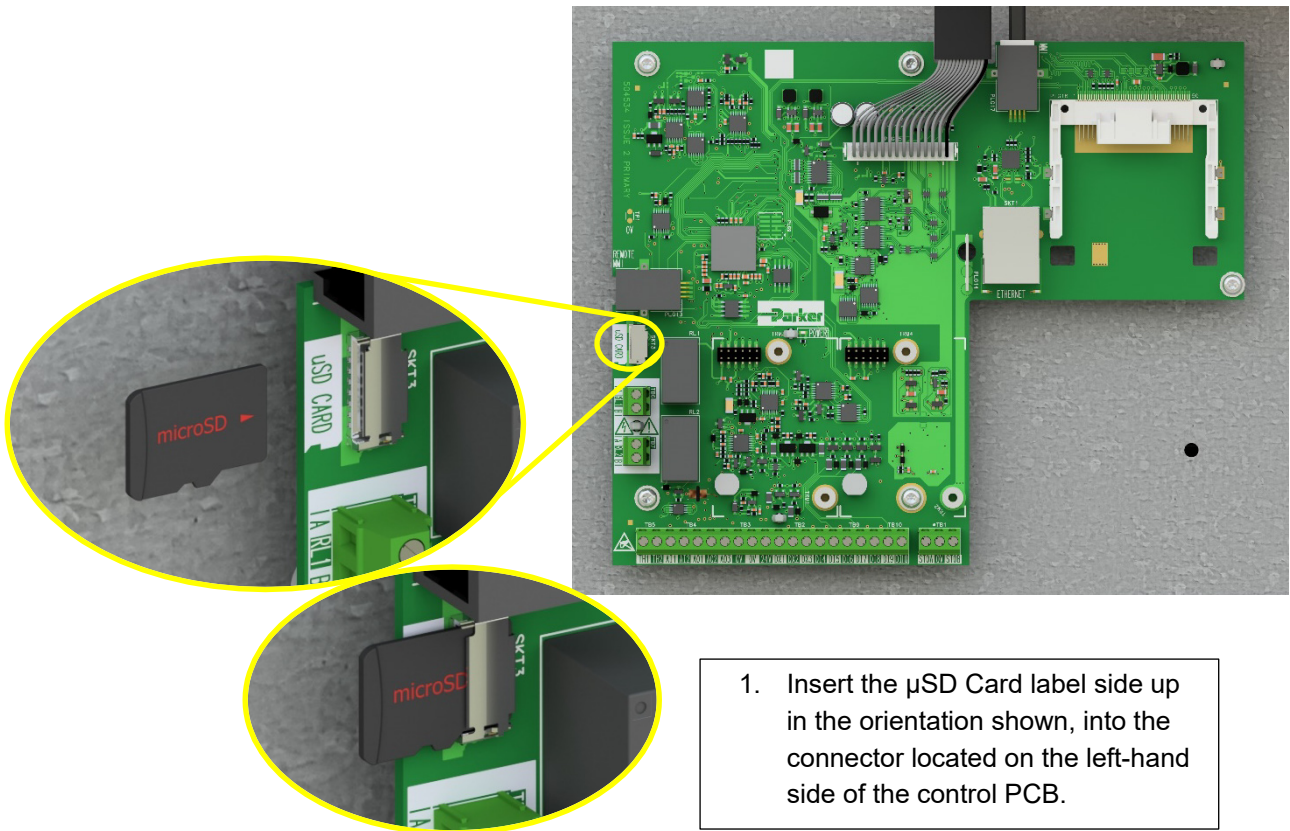

To remove the card, pull it out the slot.

## 6.6 Remote Mounted 6901 MMI

In addition to the Drive mounted keypad, there is a RJ11 port available to the user for connecting a remote mounted 6901 MMI.

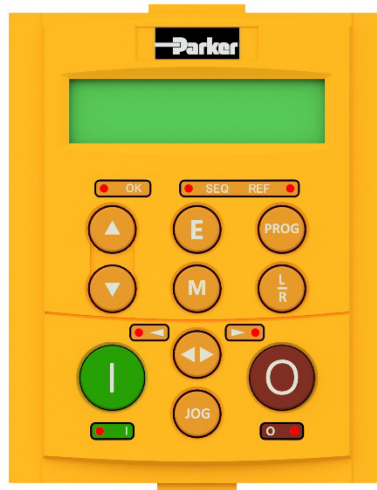

This 6901 can be useful when performing commissioning functions, or when a 6901 MMI is to be mounted remotely, i.e., on the door of a control cubicle.

### 6.6.1 Order Codes

Order Code	Description
6901-00-G	6901 Display Keypad
6052-00-G	6901 Remote Mounting Kit

### 6.6.2 Installation

The remote mounting kit (6052-00-G) is supplied with instructions and a 1-to-1 fixing template to be used during installation:

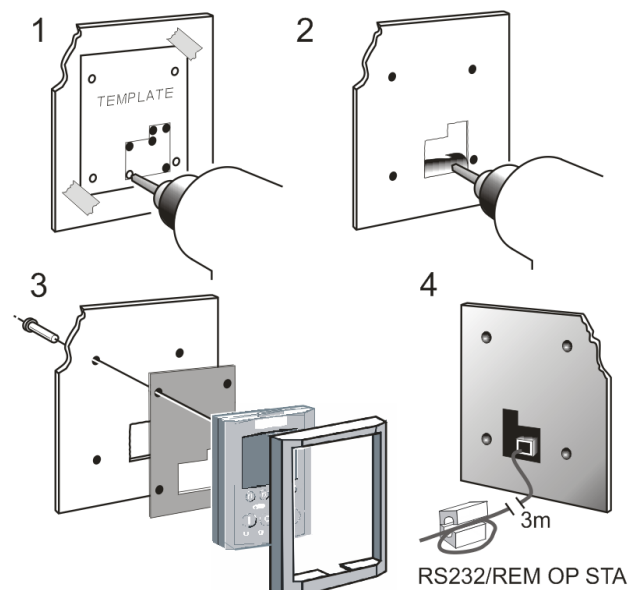
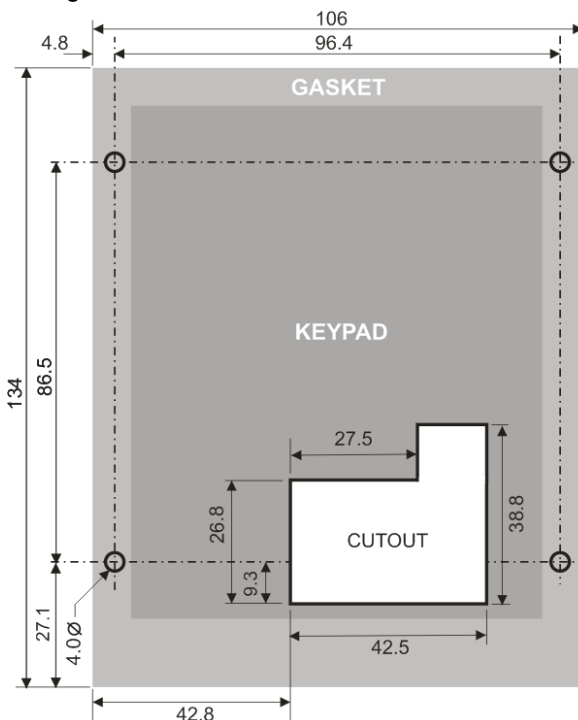



### 6.6.3 Cable Connection

#### Frames 2 – 5:

On Frames 2 – 5, the control module terminal cover will need to be removed prior to connecting the remote 6901 MMI cable.



To remove the cable, push the connector clip up towards the cable and pull away from the product.

**Frames 6 – 10:**

On Frames 6 – 10, the lower terminal cover will need to be removed prior to connecting the remote 6901 MMI cable into the control PCB.

1. Insert the cable connector clip side down into the RJ11 port on the left-hand side of the control PCB.

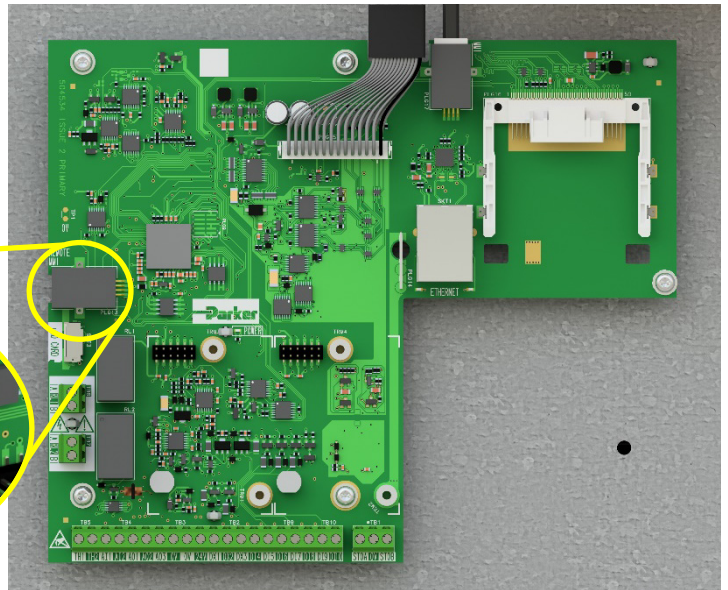
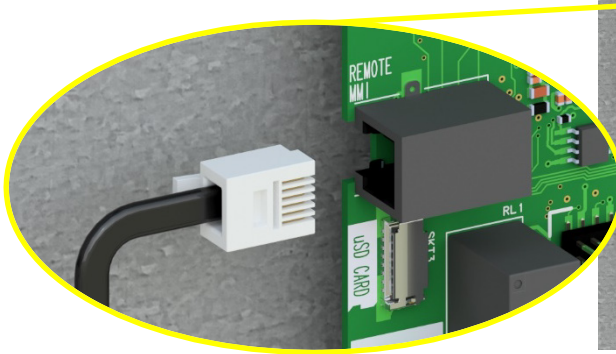

To remove the cable, push the connector clip up towards the cable and pull.

## 7 Associated Equipment

Additional mandatory equipment is required when installing an inverter (i.e., AC Line Input Fuses), as well as optional components that may be specific to the installation (i.e., Input Chokes, EMC Filters, Output Chokes) as shown in the diagram below:

- A** AC Line Fuses
- B** EMC Filter (optional)
- C** AC Line Choke (optional)
- D** Dynamic Braking Resistor (optional)
- E** AC Motor Choke (optional)
- F** Three Phase AC Induction or PMAC Motor

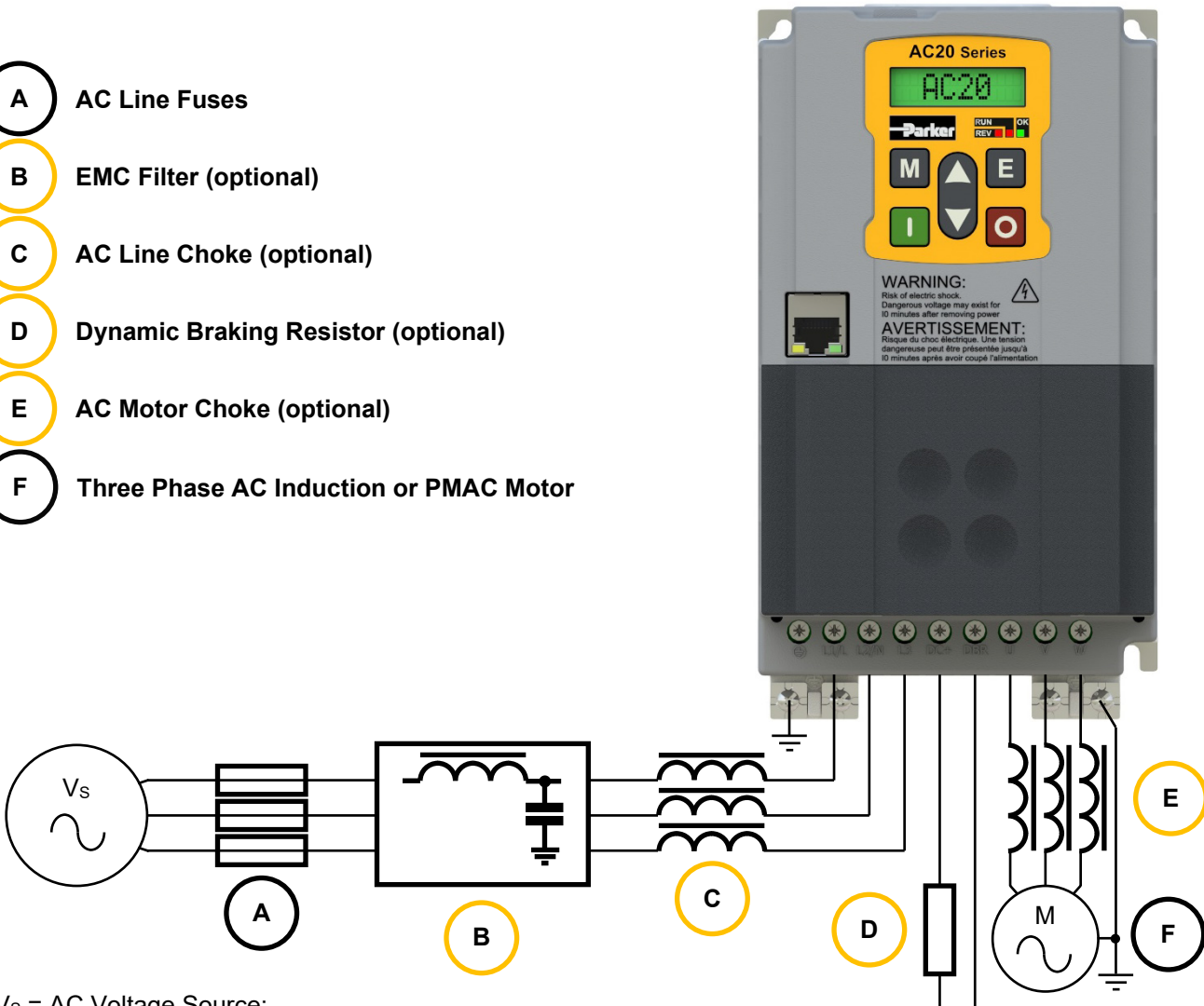

$V_s$  = AC Voltage Source:

- 1 $\phi$ , 220-240V
- 3 $\phi$ , 220-240V
- 3 $\phi$ , 380-480V

**Key:**

- Mandatory Component
- Optional Component

## 7.1 AC Line Fuses

Line input fuse ratings are given in the tables below for both European and North American & Canada territories.

For North America, the recommended fuses are either Mersen A60Q series, 600Vac/dc semiconductor protection fuses or Mersen A50QS series, 500Vac/dc semiconductor protection fuses.

These fuse series are:

1. UL recognised components.
2. Suitable for use on supplies delivering up to 50kA RMS symmetrical Amperes, 480V maximum.

Input bridge I<sup>2</sup>T values have also been provided in the table to allow customers to source suitable fuses for use in their installations.

### 7.1.1 1 $\phi$ , 230V Products

Frame Size	Product Code	Motor Power (kW)	Input Bridge I <sup>2</sup> T (A <sup>2</sup> s)	Europe	North America & Canada	
				Input Fuse Rating (A)	Input Fuse Rating (A)	Input Fuse Type
2	20G-12-0070...	1.5	508	20	25	A60Q Series
	20G-12-0100...	2.2	508	25	25	A60Q Series

### 7.1.2 3 $\phi$ , 230V Products

Frame Size	Product Code	Motor Power (kW)	Input Bridge I <sup>2</sup> T (A <sup>2</sup> s)	Europe	North America & Canada	
				Input Fuse Rating (A)	Input Fuse Rating (A)	Input Fuse Type
2	20G-32-0070...	1.5	800	10	10	A60Q Series
	20G-32-0100...	2.2	800	16	25	A60Q Series
3	20G-33-0170...	4.0	390	25	25	A60Q Series
4	20G-34-0210...	5.5	1800	32	50	A50QS Series
5	20G-35-0300...	7.5	6050	40	50	A50QS Series
	20G-35-0400...	11	6050	50	50	A50QS Series

### 7.1.3 3 $\phi$ , 400V Products

Frame Size	Product Code	Motor Power (kW)	Input Bridge I <sup>2</sup> T (A <sup>2</sup> s)	Europe	North America & Canada	
				Input Fuse Rating (A)	Input Fuse Rating (A)	Input Fuse Type
2	20G-42-0040...	1.5	360	10	10	A60Q Series
	20G-42-0065...	2.2	360	16	10	A60Q Series
	20G-42-0090...	4.0	510	20	25	A60Q Series
3	20G-43-0120...	5.5	510	20	25	A60Q Series
	20G-43-0170...	7.5	510	30	25	A60Q Series
4	20G-44-0230...	11	648	30	50	A50QS Series
	20G-44-0320...	15	1352	50	50	A50QS Series
5	20G-45-0380...	18.5	1352	50	70	A50QS Series
	20G-45-0440...	22	4485	63	100	A50QS Series
	20G-45-0600...	30	3050	100	100	A50QS Series
6	20G-46-0750...	37	16200	100	150	A50QS Series
	20G-46-0900...	45	25000	125	150	A50QS Series
7	20G-47-1100...	55	180000	160	200	A50QS Series
	20G-47-1500...	75	231200	200	300	A50QS Series
8	20G-48-1800...	90	285000	250	300	A50QS Series
	20G-48-2200...	110	285000	315	400	A50QS Series
	20G-48-2650...	132	307000	315	400	A50QS Series
9	20G-49-3200...	160	845000	400	500	A50QS Series
10	20G-410-3600...	180	845000	500	600	A50QS Series



## 7.2 External EMC Filter

Additional external EMC filters are sometimes required to meet specific conducted emissions standards and environments.

All products have internal filters that meet the Category C3 limits defined in EN61800-3. Where this performance is not adequate for a customer's application, the Conducted Emissions plots provided in 'Chapter 11: Compliance' allow for the selection or design of an additional external EMC filter to meet customer's needs.

EMC advice to consider during the product installation can also be found in this section.

## 7.3 AC Line Choke

An External AC Line Choke may be required on the line supply to the drive:

1. On supplies delivering >12kA but <50kA RMS symmetrical Amperes, 480V maximum.
2. To mitigate supply quality issues.

Where required, Parker suggest the following AC Line Choke ratings:

### 7.3.1 1 $\phi$ , 230V Products

Frame Size	Product Code	Motor Power (kW)	Inductance (mH/phase)	Rated Current (A)	Peak Current @150% HD Rating (A)
2	20G-12-0070...	1.5	1.569	14	30
	20G-12-0100...	2.2	1.098	20	42

#### Notes:

- AC Line Choke inductance values calculated @230V, 50Hz
- AC Line Choke impedance is nominally 3% of drive rating
- AC Line Choke maximum voltage rating should be 240V +10%, TN/IT
- AC Line Choke frequency of operation is 50 – 60Hz
- AC Line Choke inductance during 150% overload operation should be >90% of its nominal value

### 7.3.2 3 $\phi$ , 230V Products

Frame Size	Product Code	Motor Power (kW)	Inductance (mH/phase)	Rated Current (A)	Peak Current @150% HD Rating (A)
2	20G-32-0070...	1.5	1.355	7.8	17
	20G-32-0100...	2.2	0.961	11	23
3	20G-33-0170...	4.0	0.571	19	39
4	20G-34-0210...	5.5	0.480	22	47
5	20G-35-0300...	7.5	0.341	31	66
	20G-35-0400...	11	0.258	41	87

#### Notes:

- AC Line Choke inductance values calculated @230V, 60Hz
- AC Line Choke impedance is nominally 3% of drive rating
- AC Line Choke maximum voltage rating should be 240V +10%, TN/IT
- AC Line Choke frequency of operation is 50 – 60Hz
- AC Line Choke inductance during 150% overload operation should be >90% of its nominal value

### 7.3.3 3 $\phi$ , 400V Products

Frame Size	Product Code	Motor Power (kW)	Inductance (mH/phase)	Rated Current (A)	Peak Current @150% HD Rating (A)
2	20G-42-0040...	1.5	4.411	5	11
	20G-42-0065...	2.2	2.940	7.5	16
	20G-42-0090...	4.0	2.005	11	23
3	20G-43-0120...	5.5	1.575	14	30
	20G-43-0170...	7.5	1.192	19	39
4	20G-44-0230...	11	0.919	24	51
	20G-44-0320...	15	0.604	37	77
5	20G-45-0380...	18.5	0.501	44	93
	20G-45-0440...	22	0.432	51	108
	20G-45-0600...	30	0.315	70	148
6	20G-46-0750...	37	0.276	80	170
	20G-46-0900...	45	0.235	94	199
7	20G-47-1100...	55	0.184	120	255
	20G-47-1500...	75	0.138	160	339
8	20G-48-1800...	90	0.116	190	403
	20G-48-2200...	110	0.098	225	477
	20G-48-2650...	132	0.080	275	583
9	20G-49-3200...	160	0.067	330	700
10	20G-410-3600...	180	0.060	370	785

#### Notes:

- AC Line Choke inductance values calculated @400V, 50Hz / 480V, 60Hz
- AC Line Choke impedance is nominally 3% of drive rating
- AC Line Choke maximum voltage rating should be 480V +10%, TN/IT
- AC Line Choke frequency of operation is 50 – 60Hz
- AC Line Choke inductance during 150% overload operation should be >90% of its nominal value

### 7.3.4 Calculation

The choke ratings listed above are for guidance only. Customers may want to calculate their own ratings using the formulas below:

#### 1 $\phi$ Products:

$$L = \frac{\left( V_{in} \times \frac{Z}{100} \right)}{I_{in}} \div (2\pi \times f_{in})$$

#### Where:

- $L$  = Inductance/phase (H)
- $V_{in}$  = Line-to-Neutral Input Voltage (V)
- $Z$  = AC Line Choke Impedance (%)
- $I_{in}$  = Rated Input Current (A)
- $f_{in}$  = Mains supply frequency (Hz)

**3Ø Products:**

$$L = \frac{\left(\frac{V_{in}}{\sqrt{3}} \times \frac{Z}{100}\right)}{I_{in}} \div (2\pi \times f_{in})$$

**Where:**

- $L$  = Inductance/phase (H)
- $V_{in}$  = Line-to-Line Input Voltage (V)
- $Z$  = AC Line Choke Impedance (%)
- $I_{in}$  = Rated Input Current (A)
- $f_{in}$  = Mains supply frequency (Hz)

**7.4 Dynamic Braking Resistor**

Dynamic Brake Resistors should be used when an application requires regenerated power from the motor to be dissipated, usually during motor deceleration.

The AC20 Series products are all fitted with an internal brake switch as standard, ready for connection to an external Dynamic Brake Resistor.

**7.4.1 Resistor Power Requirement Calculation**

The Dynamic Brake Resistor must be rated to absorb peak braking power during deceleration, as well as the average power over the complete cycle. These values can be calculated using the formulas below:

**Peak Braking Power:**

$$P_{pk} = \frac{0.0055 \times J \times (n1^2 - n2^2)}{tb}$$

**Where:**

- $P_{pk}$  = Peak Braking Power (W)
- $J$  = Total Inertia (kgm<sup>2</sup>)
- $n1$  = Initial Speed (rpm)
- $n2$  = Final Speed (rpm)
- $tb$  = Braking Time (s)

**Average Braking Power:**

$$P_{av} = \frac{P_{pk}}{tc}$$

**Where:**

- $P_{av}$  = Average Braking Power (W)
- $P_{pk}$  = Peak Braking Power (W)
- $tc$  = Cycle Time (s)
- $tb$  = Braking Time (s)

**7.4.2 Resistor Selection**

Once the peak and average braking power of the application is calculated, an appropriately rated resistor will need to be selected. The resistor value will need to be higher than the minimum resistor value specified for that power stack.

Refer to 'Chapter 13: Technical Information' for minimum resistor values that can be used with each power stack.

Parker recommends the use of cubicle mount metal clad resistors and offer an optimised range, specified below:

Order Code	Power Rating (W)	Resistance ( $\Omega$ )	Continuous Current Rating (A)
CZ467715	60	500	0.3
CZ467714	100	200	0.7
CZ389853	100	100	1.0
CZ467717	200	100	1.4
CZ388397	200	56	1.9
CZ463068	200	56	1.9
CZ467716	500	56	3.0
CZ388396	500	36	3.7

It is recommended that a large safety margin be incorporated to ensure that the resistors are not overloaded.

### 7.4.3 Resistor Protection Devices

Where a Dynamic Brake Resistor is used, Parker recommends the addition of a thermal overload switch (motor starter) or fuse (of aM type or equivalent), to be fitted in series with the resistor. This is to provide protection to the component:

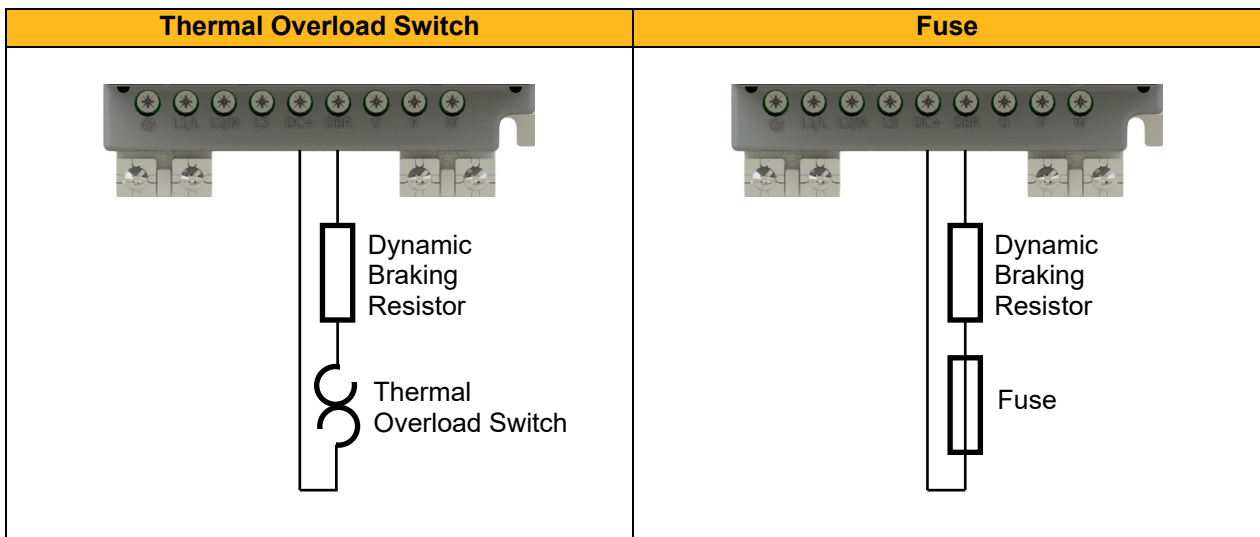

It is recommended the thermal overload switch / fuse is sized with a 10% margin greater than the theoretical continuous current.

Where a fuse is used, consideration must also be taken to ensure that the peak current in the resistor is less than 6.3x the nominal fuse rating.

Users should also be aware of the instantaneous power in the resistor.

**Note: The values mentioned above are general guidelines. The user should check the I\*t curves in the component datasheet when sizing the correct protection device for the application.**

**Dynamic Brake Resistor Protection Current Calculation:**

$$I_{prot} = \frac{\sqrt{P_{cont}}}{R_{db}} \times 1.1$$

**Where:**

$I_{prot}$  = Resistor Protective Current (A)

$P_{cont}$  = Continuous Braking Power (W)

$R_{db}$  = Dynamic Braking Resistor ( $\Omega$ )

**Dynamic Brake Resistor Peak Current Calculation:**

$$I_{pk} = \frac{V_{db}}{R_{db}}$$

**Where:**

$I_{pk}$  = Dynamic Brake Resistor Peak Current (A)

$V_{db}$  = Dynamic Brake Resistor Threshold Voltage (V): **382V** (230V products) / **764V** (400V products)

$R_{db}$  = Dynamic Braking Resistor ( $\Omega$ )

**Dynamic Brake Resistor Peak Instantaneous Power Calculation:**

$$P_{pkinst} = \frac{V_{db}^2}{R_{db}}$$

**Where:**

$P_{pkinst}$  = Dynamic Brake Resistor Peak Instantaneous Power (kW)

$V_{db}$  = Dynamic Brake Resistor Threshold Voltage (V): **382V** (230V products) / **764V** (400V products)

$R_{db}$  = Dynamic Braking Resistor ( $\Omega$ )

## 7.5 AC Motor Choke

The maximum rate of Voltage rise (dv/dt) present at the inverter output can be as high as 10,000V/ $\mu$ s.

Adding an AC Motor Choke between the inverter output and motor:

1. Reduces the dv/dt and peak voltages present at the motor, which in turn reduces the stress applied to the motor insulation.
2. Eliminates potential nuisance overcurrent trips in installations with long motor cable runs.
3. Limits parasitic capacitance flowing to earth.

Refer to 'Chapter 11: Compliance' for maximum motor cable lengths.

Where a choke is deemed necessary, Parker suggest the following AC Motor Choke ratings:

### 7.5.1 1 $\phi$ , 230V Products

Frame Size	Product Code	Motor Power (kW)	Inductance (mH/phase)	Rated Current (A)	Peak Output Current (A)
2	20G-12-0070...	1.5	1.208	7.0	13
	20G-12-0100...	2.2	0.845	10	19

**Notes:**

- AC Motor Choke inductance values calculated @230V, 50Hz
- AC Motor Choke impedance is nominally 2% of drive rating
- AC Motor Choke maximum voltage rating should be 240V +10%, TN/IT
- AC Motor Choke frequency of operation is 0 – 120Hz
- AC Motor Choke inductance at peak current should be >85% of its nominal value

### 7.5.2 3 $\phi$ , 230V Products

Frame Size	Product Code	Motor Power (kW)	Inductance (mH/phase)	Rated Current (A)	Peak Output Current (A)
2	20G-32-0070...	1.5	1.006	7.0	13
	20G-32-0100...	2.2	0.704	10	19
3	20G-33-0170...	4.0	0.414	17	32
4	20G-34-0210...	5.5	0.335	21	40
5	20G-35-0300...	7.5	0.235	30	57
	20G-35-0400...	11	0.176	40	76

#### Notes:

- AC Motor Choke inductance values calculated @230V, 60Hz
- AC Motor Choke impedance is nominally 2% of drive rating
- AC Motor Choke maximum voltage rating should be 240V +10%, TN/IT
- AC Motor Choke frequency of operation is 0 – 120Hz
- AC Motor Choke inductance at peak current should be >85% of its nominal value

### 7.5.3 3 $\phi$ , 400V Products

Frame Size	Product Code	Motor Power (kW)	Inductance (mH/phase)	Rated Current (A)	Peak Output Current (A)
2	20G-42-0040...	1.5	3.676	4.0	7.6
	20G-42-0065...	2.2	2.262	6.5	12
	20G-42-0090...	4.0	1.634	9.0	17
3	20G-43-0120...	5.5	1.225	12	23
	20G-43-0170...	7.5	0.865	17	32
4	20G-44-0230...	11	0.639	23	44
	20G-44-0320...	15	0.459	32	61
5	20G-45-0380...	18.5	0.387	38	72
	20G-45-0440...	22	0.334	44	84
	20G-45-0600...	30	0.245	60	114
6	20G-46-0750...	37	0.196	75	143
	20G-46-0900...	45	0.163	90	171
7	20G-47-1100...	55	0.134	110	209
	20G-47-1500...	75	0.098	150	285
8	20G-48-1800...	90	0.082	180	342
	20G-48-2200...	110	0.067	220	418
	20G-48-2650...	132	0.055	265	504
9	20G-49-3200...	160	0.046	320	608
10	20G-410-3600...	180	0.041	360	684

#### Notes:

- AC Motor Choke inductance values calculated @400V, 50Hz / 480V, 60Hz
- AC Motor Choke impedance is nominally 2% of drive rating
- AC Motor Choke maximum voltage rating should be 480V +10%, TN/IT
- AC Motor Choke frequency of operation is 0 – 120Hz
- AC Motor Choke inductance at peak current should be >85% of its nominal value

## 7.5.4 Calculation

The choke ratings listed above are for guidance only. Customers may want to calculate their own ratings using the formula below:

$$L = \frac{\left(\frac{V_{out}}{\sqrt{3}} \times \frac{Z}{100}\right)}{I_{out}} \div (2\pi \times f_{out})$$

**Where:**

- $L$  = Inductance/phase (H)
- $V_{out}$  = Line-to-Line Output Voltage (V)
- $Z$  = AC Motor Choke Impedance (%)
- $I_{out}$  = Rated Output Current (A)
- $f_{out}$  = Output frequency (Hz)

## 8 Safe Torque Off (STO): SIL2, PLd

### 8.1 Overview

#### 8.1.1 Introduction

The AC20 is an adjustable speed electrical power drive system that is suitable for safety related applications (PDS(SR)).

The drive is used in typical applications such as pump controls, packaging machines, textile machines, printing machines, or material forming machines.

Safe Torque Off (STO) is an important and widely used safety function, deployed to prevent the unexpected start-up of motors.

STO functionality enables an operator to disable the torque at motor shafts or deactivate forces at linear motors and actuators via digital inputs, before commencing work in a potentially hazardous area.

#### Application block diagram

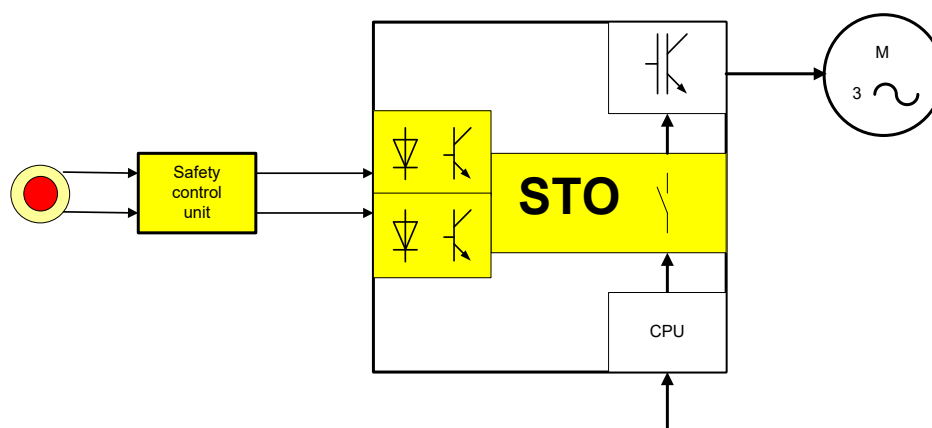

This section provides general information about Safe Torque Off (STO).

Two safety functions can be implemented with the inverter:

1. Safe Torque Off (STO)
2. Safe Stop 1 (SS1).

In order to meet all aspects of STO and SS1, an external safety control unit should be used.

To implement Safe Stop 1 (SS1), the external safety control unit causes the drive to decelerate to rest.

Once at rest, it invokes STO in the inverter. Please refer to EN61800-5-2:2017 para 4.2.3.3 for the formal definitions.

It is the user's responsibility to:

1. Risk assess the machine.
2. Design, implement and assess an appropriate solution for each application to meet all relevant safety requirements.

In accordance with the machine standards 2006/42/EG, EN ISO 12100, EN ISO 13849-1 and EN ISO 14121-1, it is the machine manufacturer who must project the safety system for the entire machine, including all integrated components. This includes the electrical drives.

Note: STO is an electronic inhibit intended for use during normal operation of the machine, but It can also be used in automatic, set-up and cleaning operation modes. However, it is not intended for use during machine maintenance, repair, replacement or other similar activities. For these activities, recognised electrical power isolation devices and lock-off procedures should be used.

The inverter STO function is a factory-fitted and factory-tested feature. See 'Section 8.5: STO Safety Warnings and Limitations'.



## 8.1.2 STO Functional Description

STO is a means of preventing an inverter from delivering rotational force to its connected electric motor. Please refer to EN61800-5-2:2017 para 4.2.3.2 for the formal definition.

To ensure a high degree of safety, two independent STO control channels are implemented in hardware, providing the safety sub function STO. The STO circuits in the inverter are designed such that a fault in one control channel will not affect the other channel's ability to prevent the drive from starting, i.e., the STO function of the inverter is tolerant to any single fault. It may not be tolerant to an accumulation of faults. This is in keeping with its declared safety ratings. For complete STO functionality, it is necessary to use the motor with the correct motor cable and correct STO input wiring.

STO always overrides any attempt to start the drive. If one or both STO control inputs is requesting the STO function, the drive will not start, even if for example, the drive's software malfunctions and tries to cause the motor to turn.

The STO function is implemented in hardware; it overrides all software activities. The only software involvement is to report the STO status to the user via the onboard inverter display or remote keypad (MMI), serial communications link, or user terminal as defined by the drive configuration.

## 8.2 Alignment to European Standards

### 8.2.1 EN ISO13849-1:2015 (Safety of machinery – Safety-related parts of control systems)

STO aligns internally to the following aspects of this standard:

#### 1. Architecture According to Category 3:

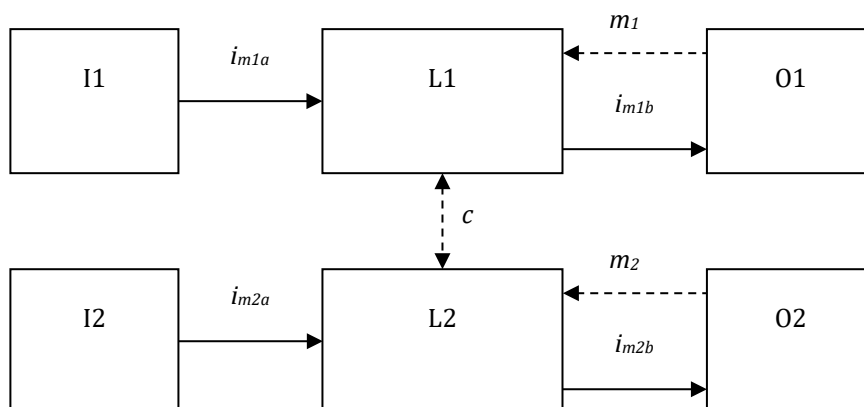

Where:

$I1, I2$  = User Terminal

$L1, L2$  = Logic

$O1, O2$  = Methods of Enabling/Disabling Output Power

$O1, O2$  = Devices

$i_{mxy}$  = Interconnecting Means

$m_x$  = Monitoring

$c$  = Cross Monitoring

—▶ = STO Control Paths

- - - -▶ = Reasonably Practicable Fault Detection

**2. General Requirements of Category 3:**

- A single failure will not lead to loss of the STO safety function.
- Failure of more than one component can lead to the loss of the STO safety function.
- Most but not all single component failures will be detected. Diagnostic Coverage (DC) is required to be at least 60% (i.e., the minimum required for 'low' diagnostic coverage).
- Detected component failures will result in the STO function being applied without intervention from the user.
- The risk associated with the loss of STO safety function caused by multiple failures must be understood and accepted by the user.
- The user must undertake a risk analysis and specify suitable components that, when connected together, meet the risk assessment requirements.
- Mean Time To Failure (dangerous) (MTTFd) of each STO channel must be  $\geq 30$  years.
- Common Cause Failure (CCF) score must be  $\geq 65$  according to Annex F of the standard.

**3. Performance Level (PL) d:**

- Average probability of dangerous failure per hour (PFH) must be  $\leq 10^{-6}$

**8.2.2 EN61800-5-2:2017 (Adjustable speed electrical power drive systems) & EN61508:2010 (Functional safety of electrical/electronic/programmable electronic safety-related systems)**

STO aligns to the following aspects of this standard:

**Safety Integrity Level (SIL) 2:**

- Probability of dangerous random hardware failures per hour (PFH) must be  $\leq 10^{-6}$
- Subsystems type A according to EN61508-2:2010 para 7.4.4.1.2.

**8.3 Specification**

**8.3.1 Safety**

As assessed to EN ISO13849-1:2015 and EN61800-5-2:2017, the inverter has the following related safety values:

<b>PL (STO):</b>	d
<b>SIL (STO):</b>	2
<b>PFH (STO):</b>	$4.6 \times 10^{-10}$ 1/h †
<b>Mission Time:</b>	Maximum 20 years
<b>Fault Detection Time:</b> (Time delay from unequal input logic levels to activation of STO)	Maximum 5sec During input inequality, the motor torque is disabled by the single channel within 15 msec.
<b>STO Response Time:</b> (Time from STO user input initiating removal of energy to the motor)	Maximum 15msec
<b>STO Input Pulse Time:</b> (Active low OSSD from external safety control unit)	Maximum 1.5msec
<b>STO Failure:</b>	If an STO 'Trip 31' code cannot be acknowledged, then defects could be present in the product or in the external STO wiring. Any reported STO fault will require system analysis to establish the cause. Damaged units will need to be exchanged.



† = Note that in assessment of the danger point, the total failure rate is determined by the sum of the failure of all parts

### 8.3.2 EMC

In addition to the mandatory requirements of EN61800-3, the STO functionality has been subjected to testing for immunity at higher levels. In particular, the STO function (only) has been tested for radiated immunity according to EN61800-5-2:2017 Annex E up to 6GHz which includes frequencies used by mobile transmitters in general.

## 8.4 STO Operation

### 8.4.1 Terminal Identifications

Frames 2 - 5	Frames 6 - 10
	

Terminal Ident	Description
STOA	STO Input Channel A: <ul style="list-style-type: none"> <li>- 0V or not connected, STO is 'Active' on channel A. Drive will not run.</li> <li>- 24V, STO is 'Disabled' on channel A. Drive will run, providing 24V is present on STO input channel B too.</li> <li>- Input is optically isolated from all other inverter terminals except STOB.</li> </ul>
0V	STO 0V Reference: <ul style="list-style-type: none"> <li>- Signal return for STO input channel A and STO input channel B.</li> <li>- This terminal must be connected to earth at one common point in the drive system.</li> </ul>
STOB	STO Input Channel B: <ul style="list-style-type: none"> <li>- 0V or not connected, STO is 'Active' on channel B. Drive will not run.</li> <li>- 24V, STO is 'Disabled' on channel B. Drive will run, providing 24V is present on STO input channel A too.</li> <li>- Input is optically isolated from all other inverter terminals except STOA.</li> </ul>

### 8.4.2 Input State Truth Table

STO Input Channel A	STO Input Channel B	STO Status	Description
0V	0V	STO ACTIVE	Inverter cannot start or supply power to the connected motor. STO trip reported by the inverter.
24V	0V	STO ACTIVE (Abnormal one-channel operation detection)	Inverter cannot start or supply power to the connected motor. STO trip reported by the inverter. If either of these conditions persists for more than 1sec, the STO function <b>can</b> lock into a Fault state. If either of these conditions persists for more than 5sec, the STO function <b>will</b> lock into a Fault state. Once in the Fault state, the inverter cannot start until it has been power cycled (both mains power and any auxiliary 24V supply).
0V	24V		
24V	24V	STO INACTIVE	Inverter is enabled to run and supply power to the connected motor under software control.
X	X	INVERTER UNPOWERED	Inverter cannot start or supply power to the connected motor.

### 8.4.3 Example Applications

**WARNING!**

**Diagrams are for illustration only:**



The wiring examples shown in this section are for illustration only. They are not to be considered as 'final' designs, nor as an attempt to create a design for specific solutions. The user / installer is responsible for designing a suitable system to meet all requirements of the application including assessing and validating it. Parker will not accept any liability for failure to do this or any consequential loss or damage.



#### Applications NOT Requiring STO Functionality:

The example below shows the drives' 24V output voltage used to permanently wire the STO inputs in the 'High' state, i.e., STO **DISABLED** (drive operational):

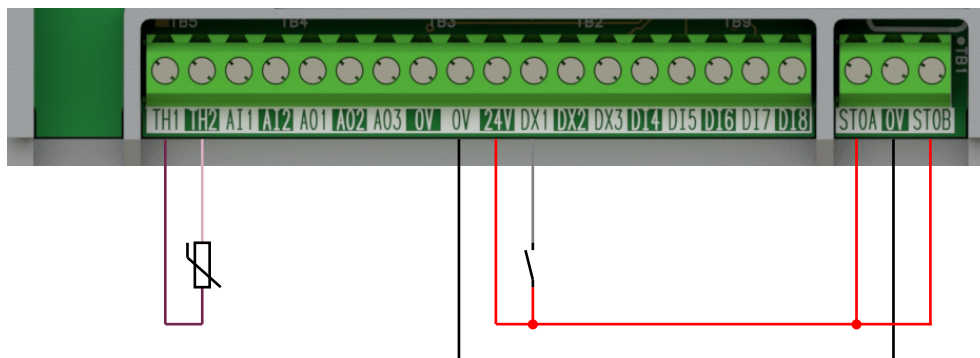

Configuration Setup:	
TH1	Motor Thermistor '+' connection
TH2	Motor Thermistor '-' connection
DX1	<b>Run Forward:</b> 24V digital input
STOA	24V input connected i.e., STO <b>DISABLED</b> (drive operational)
STOB	24V input connected i.e., STO <b>DISABLED</b> (drive operational)

### Minimum STO Implementation:

This example shows 'STO Request' contacts that are used to invoke STO on the drive. These contacts are required to close prior to running the drive:

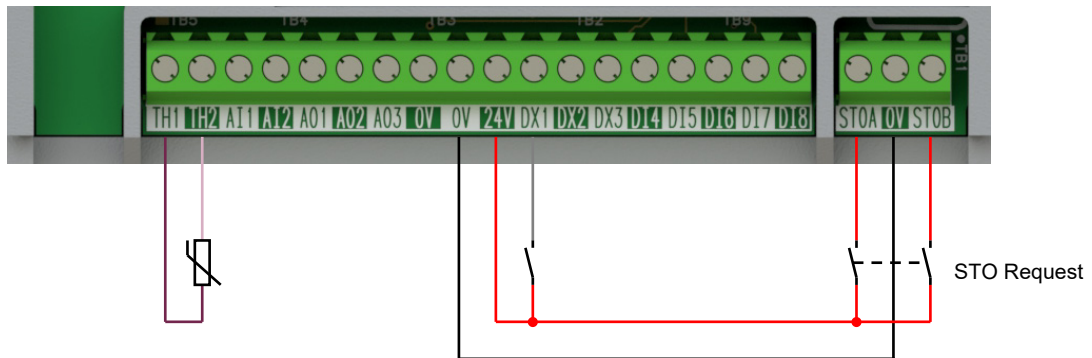

Configuration Setup:	
TH1	Motor Thermistor '+' connection
TH2	Motor Thermistor '-' connection
DX1	<b>Run Forward:</b> 24V digital input
STOA	24V input connected via ' <b>STO Request</b> ' contacts
STOB	24V input connected via ' <b>STO Request</b> ' contacts

To run the drive:

1. Close the 'STO Request' contacts.
2. Close the 'Run Forward' contact.

To stop the drive:

1. Open the 'Run Forward' contact and wait for the motor to come to a standstill.

To invoke STO:

1. When the motor is at standstill, open the 'STO Request' contacts.
2. STO will now be 'Active' on the drive, for as long as required.

**Note:** Opening the 'STO Request' contacts when the motor is running will result in the motor coasting to a stop.

### STO Implementation with a Door Switch (Stop Category 0):

This example shows a safety door switch that is used to invoke STO on the drive when the safety door is 'opened', allowing access into the 'Danger Zone'.

The safety door must return to the 'closed' position prior to running the drive:

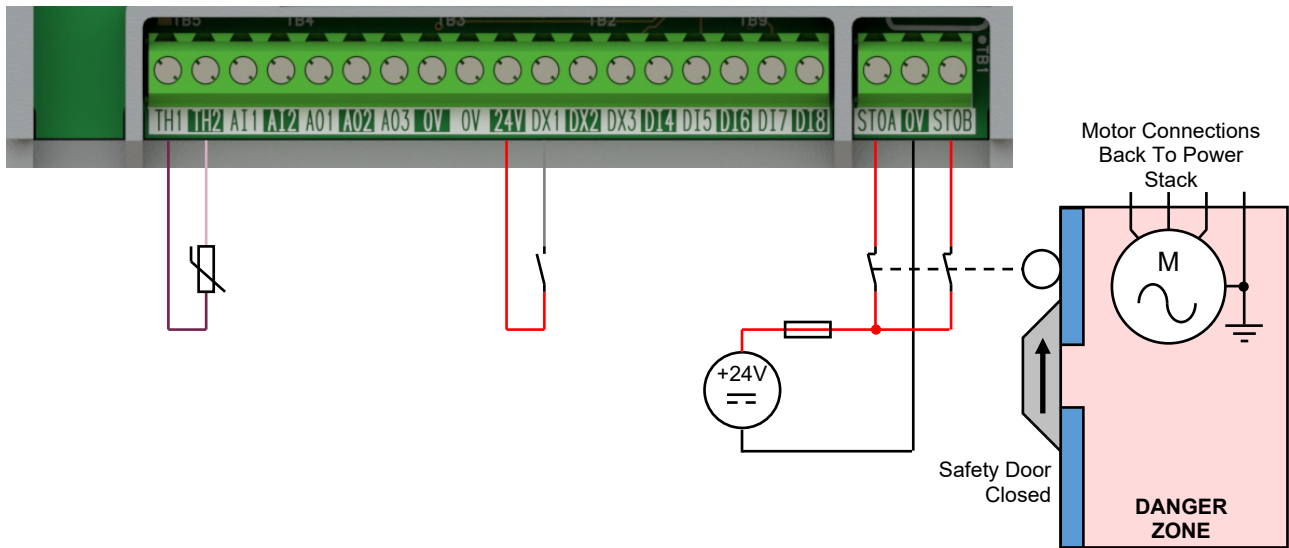

Configuration Setup:	
TH1	Motor Thermistor '+' connection
TH2	Motor Thermistor '-' connection
DX1	<b>Run Forward:</b> 24V digital input
STOA	Externally fused 24V input connected via ' <b>Safety Door Closed</b> ' contacts
STOB	Externally fused 24V input connected via ' <b>Safety Door Closed</b> ' contacts

To run the drive:

1. Close the 'Safety Door' so the contacts and closed circuit (STOA & STOB inputs are supplied with 24V).
2. Close the 'Run Forward' contact.

To stop the drive:

1. Open the 'Run Forward' contact and wait for the motor to come to a standstill.

To invoke STO:

1. When the motor is at standstill, open the 'Safety Door' so that the contacts are open circuit (no volts on STOA & STOB inputs).
2. STO will now be 'Active' on the drive, for as long as required.

**Note: Opening the 'Safety Door' so that the contacts open when the motor is running will result in the motor coasting to a stop.**

The line guiding to the external switches must be separated channel-wise or they must be specially protected i.e., using shielded cables. A relocation of this wiring is not permitted.

In the example illustrated above, the contacts of the 'Safety Door' need to be designed mechanically linked, in accordance with EN 60947-5-1, annex K.

## SS1 / STO Implementation using a Safety Control Unit (Stop Category 1):

The example below shows Safe Stop (SS1) implementation that brings a motor to rest in a controlled manner, before invoking STO on the drive after a time delay determined by an external Safety Control Unit.

The Safety Control Unit shown in this example is a Sick UE410-MU module. This configuration conforms to SS1 as defined in EN 61800-5-2:2017 para 4.2.3.3 c). Other products are available on the market that may better suit user's application, so the user must select and assess appropriate equipment:

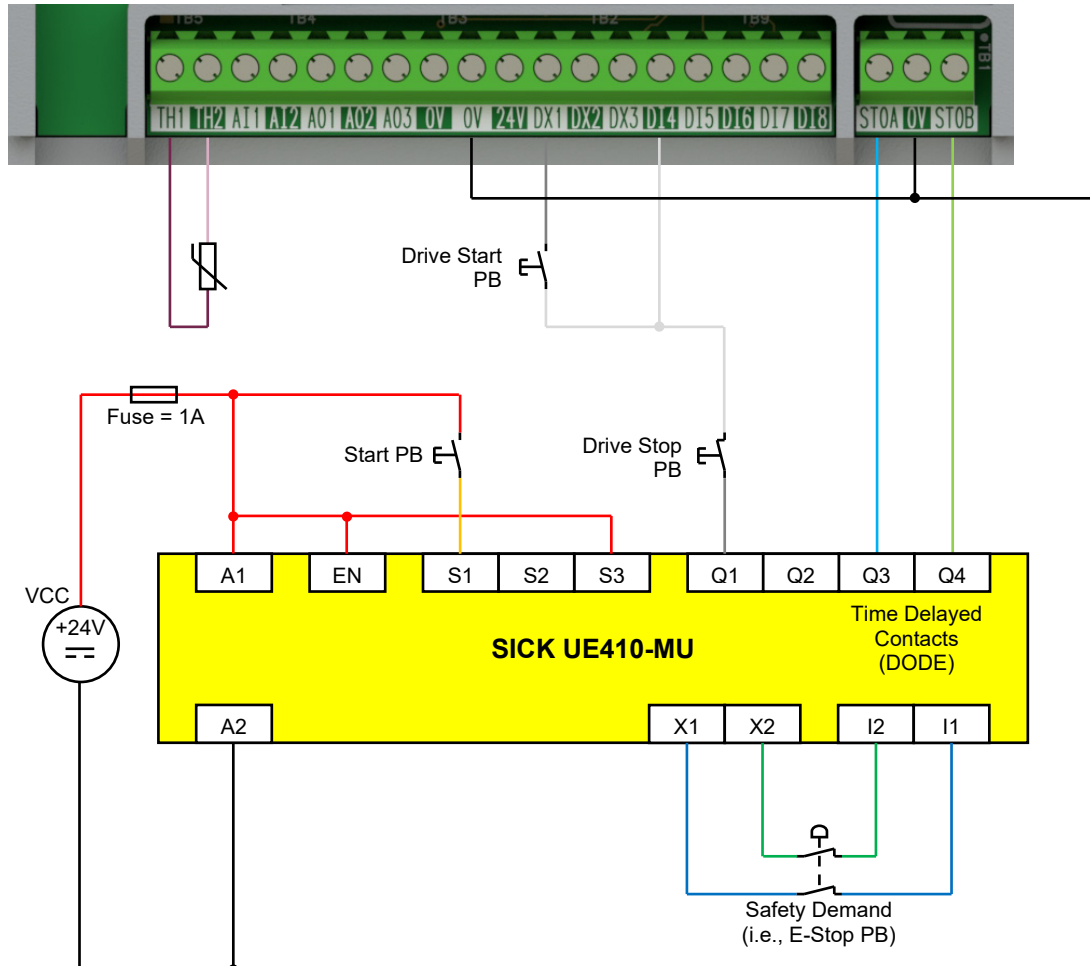

Configuration Setup:	
TH1	Motor Thermistor '+' connection
TH2	Motor Thermistor '-' connection
DX1	<b>Run Forward:</b> 24V digital input
DI4	<b>Stop:</b> 24V digital input
STOA	24V input connected via 'Safety Control Unit' DODE o/p signal
STOB	24V input connected via 'Safety Control Unit' DODE o/p signal

**Note:** The maximum input level of STOA & STOB inputs is 25.2V. This must be taken into consideration when selecting a 24V power supply to generate VCC, i.e.  $VCC(max) < 25.2V$ .

On system power-up:

1. The Safety Control Unit outputs are de-energised (open-circuit), so STO on the drive is invoked (active).

To run the drive:

1. Ensure that the 'Safety Demand' is reset, i.e., contacts are closed.
2. Close the 'Start PB' switch to ensure the Safety Control Unit is reset. This should enable outputs Q3 & Q4, applying 24V onto STOA & STOB inputs, and hence disabling the STO function.

3. Close the 'Drive Start PB' switch to run the drive.

To stop the drive:

1. Open the 'Drive Stop PB' switch and wait for the motor to come to a standstill.

To invoke STO:

1. Open the 'Safety Demand' contacts.
2. If the motor is running, the Safety Control Unit output Q1 will initiate a drive 'Stop' to decelerate the motor to a standstill.
3. Safety Control Unit outputs Q3 & Q4 are configurable DODE (Delay on de-energise) signals that will de-energise on initiation, after a delay time.

The delay time must be setup on the Safety Control Unit device so that the maximum deceleration time of the drive has ensured the motor is at a standstill before the delay time has elapsed.

**Note: Opening the 'STO Demand' contacts when the motor is running with an insufficient delay time set, will result in the motor coasting to a stop.**

4. Once the time delay has elapsed on Safety Control Unit outputs Q3 & Q4, the outputs will de-energise, and hence STO will now be 'Active' on the drive for as long as required.

Timing diagram (Typical Operation):

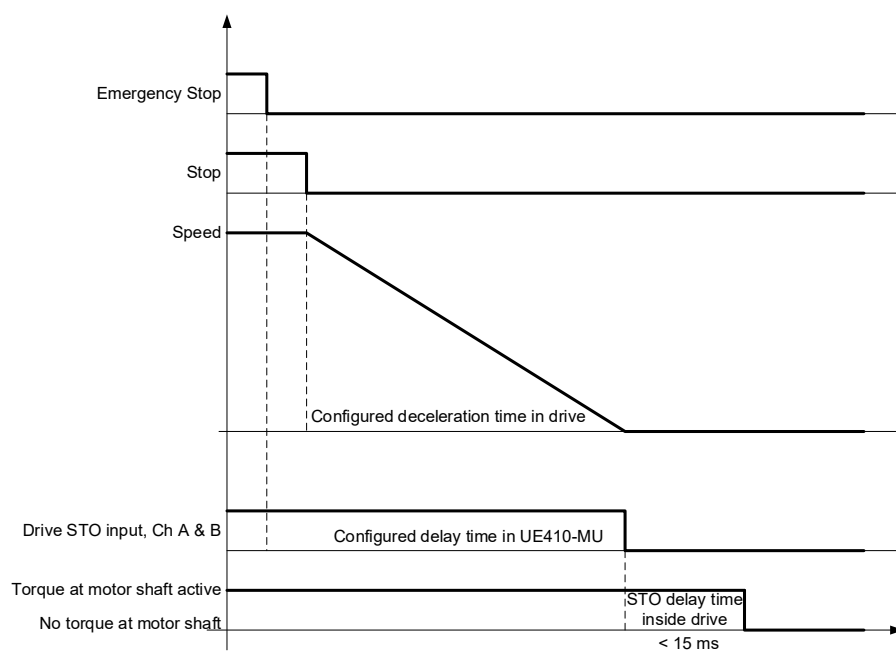

**Note: The Q1 output signal from the Safety Control Unit works using test pulses. Therefore, the digital input signal received by the drive must be filtered. This can be implemented by adding a 'Debouncing' Function block to the relevant input signal using the DSELite configuration tool.**

In the example illustrated, the contacts of the 'Safety Demand' (i.e., Emergency Stop button) need to be designed mechanically linked, in accordance with EN 60947-5-1, annex K.

Other Safety Control Units can be used if it meets all requirements for cat 3 and PLd that have a high-quality fault detection method with dynamic cross monitoring test pulses. The maximum test pulse time of these devices must be < 1.5msec (active low OSSD).

For the delayed initiation of STO, the machinery risks have to be considered from the machine designer.



## 8.4.4 Technical Specification

<b>Terminal Idents:</b>	STOA, STOB, referenced to 0V
<b>Nominal Input Voltage:</b>	24V PELV (with energy source class 3, according to IEC 62368-1)
<b>Maximum Input Voltage:</b>	25.2V (26.4V in a maximum operating ambient of 40°C)
<b>Recommended Input Voltage for Logic Low Level:</b>	0V – 5V (or open circuit)
<b>Recommended Input Voltage for Logic High Level:</b>	15V – 24V
<b>Indetermined Input Range:</b>	5V – 15V, function is undefined
<b>Typical Input Current:</b>	9mA @ 24V
<b>STO Input Operability:</b>	Always Active (i.e., STO cannot be disabled by the drive firmware)
<b>STO User Input A Logic Level:</b>	0V or open circuit = STO Activated 24V = STO Disabled
<b>STO User Input B Logic Level:</b>	0V or open circuit = STO Activated 24V = STO Disabled
<b>Isolation:</b>	Channel A & B to SELV: Galvanic Isolation. Channel A to Channel B: Non-isolated

## 8.5 STO Safety Warnings & Limitations



### WARNING!

**Ignoring the following may result in serious injury or death:**



- Only competent personnel are permitted to install the STO function and commission it. They must disseminate and make available all appropriate instructions and documentation to all personnel who may come into contact with or operate the STO and provide suitable training on the inverter to ensure it is operated in the correct manner and to avoid damage, injury or loss of life. Personnel with many years of experience in the field of machine safety with inverters is expected. Planning, installation and initial system commissioning requires a detailed understanding in this area.
- Standards and accident prevention regulation associated with the application must be known and respected as well as risks, protective and emergency measures.
- We assume that these specialists have a good knowledge of English. In the case of deviating regulations (in particular work by persons who do not speak English), the machine manufacturer must provide these persons with the necessary information in the national language.

- It is not permitted to open the inverter for repair or modification. The inverter STO function is a factory-fitted and factory-tested feature. Repairs to the inverter STO featured-product are to be carried out only by Parker authorised repair centres. Any unauthorised attempt to repair or disassemble the product will render any warranty null and void, and STO integrity could be impaired.

PARKER WILL NOT ACCEPT ANY LIABILITY FOR FAILURE TO OBEY THESE INSTRUCTIONS OR FOR ANY CONSEQUENTIAL INJURY, DEATH, LOSS OR DAMAGE.

Only competent personal with relevant experience are allowed to open the inverter for making changes to the power filters (i.e. removal of Y-Caps & VDR earth connections), or fitting optional communication cards.

If internal connections between the power stack and control card have been disconnected and reconnected, then the accurate connection must be checked by starting the motor (running the drive), and by performing a STO comprehensive check as specified in Section 8.6.1 below.

- It is important that the inverter product environment including all aspects of its CE conformance and IP etc., specified elsewhere in this manual, is maintained to ensure the safety integrity of the STO function.
- Should synchronous motors be operated in the field weakening range, operation of the STO function may lead to overspeed and destructive overvoltages as well as explosions in the drive. Therefore, the STO function must NEVER be used with synchronous drives in the field-weakening range. The user must ensure this condition is prevented.
- When using synchronous permanent magnet motors, shaft movement over a small angle is possible if two faults occur simultaneously in the power section of the drive. This depends on the number of motor poles. The maximum angle is:
  - Rotary motors:  $360^\circ / \text{number of poles}$ .
  - Linear motors:  $180^\circ$  electrically

It is the user's responsibility to assess, validate and safeguard as necessary against this potential hazard.

- If external forces can act on the motor and/or load to cause it to move, additional measures must be taken by the user to restrain it, for example a mechanical brake. Examples of external forces are suspended loads (effect of gravity), and other web-tensioning devices. This must be respected above all for vertical axes without self-locking mechanical devices or weight balance.
- The inverter STO feature does not provide or guarantee any galvanic isolation in accordance with EN 60204-1 Section 5.5. This means that the entire system must be isolated from the mains power supply with a suitable electrical isolation device before any drive or motor maintenance or replacement procedures are attempted. Note that even after the power has been isolated, dangerous electrical voltages may still be present in the inverter. Safe discharge times and details are specified in 'Chapter 1: Safety' section of this manual.

- The STO function must not be used for electrical isolation of the inverter and power. Whenever any personnel require to work on the drive, associated motor or other power items, they must always use recognised and suitable electrical isolation devices.
- The STO0V terminal must be connected to earth at one common point in the drive system. For multi-drive systems this can be a shared earth point.
- The STO serial communications or display messages relating to accessing or viewing any safety monitoring statuses are for information only and should not be relied on. They are not part of the drive module safety system and its associated PL/SIL declared ratings. Any customer use of these must be appropriately risk assessed in accordance with the relevant standards or regulations.
- The STO safety function must be tested regularly - at least once a week (see Section 8.6.3 below). The comprehensive test must be completed once a year (see section 8.6.1 below).
- When using an external safety control unit with adjustable time delay, for example when implementing an SS1 function, the time delay must be protected to prevent unauthorised adjustment. The adjustable time delay on the safety control unit must be set to a value greater than the duration of the braking ramp controlled by the inverter with maximum load inertia and from maximum speed. Any external forces must also be considered, e.g. effects due to gravity.
- During the active braking phase of SS1 or Stop category 1 (controlled stop with safely monitored time delay according to EN60204-1), faulty operation of the drive must be allowed for. If a fault in the drive system occurs during the active braking phase, the load may coast to an unguided stop or might even actively accelerate until expiration of the defined time delay. It is not the remit of this document to specify these measures. This is for the user to assess.
- It is the user's responsibility to ensure that their overall control implementation recovers safely from supply loss or dips.
- In all instances it is the user's responsibility to formally perform suitable risk assessments and invoke and fully validate the necessary risk reduction measures after having thoroughly understood the application, the drive product, and its features. Of special relevance is to assess the risk of the two STO user inputs shorting together.
- There is maximum cable length of 25m for the STO inputs allowed.

## 8.6 STO Functional Checks

Two levels of STO functional checks are required periodically:

- Comprehensive check
- Regular check

The user / machine builder must determine the frequency of these checks based on their knowledge, use of the machine, appropriate standards and any legal requirements.

When STO becomes active during any test, power to the motor must be seen by the user to be quenched instantaneously (the inverter should respond in less than 15 milliseconds).

All STO checks should be performed after the inverter has been commissioned for speed control.

## 8.6.1 Comprehensive Checks

A comprehensive check of the STO function ensures the overall integrity of the STO functionality. It proves the independent operation of each channel individually (including during the normal dual channel operation), and the essential single fault detection.



It must always be performed:

- During factory test.
- During commissioning activities.
- After repair or replacement of the inverter.
- After any hardware or software design changes which may affect the inverter concerned.
- After each intervention into the system and control wiring.
- A minimum of once per year.
- If the machine has been idle for more than a period of time determined by the machinery builder and user risk assessments.

The check must be made by suitably qualified professional personnel following all necessary safety precautions. They must be fully conversant with all equipment concerned.

**Note:** In the following text where it is required that “all power” is removed, remove power and wait 10 minutes.

The performance of the individual test steps of the STO function should be logged.

<b>WARNING!</b>		
<b>Potential loss of Safety Function:</b>		
	<p>During this test, the safety function must not be relied on because at times only one channel will be activated and therefore the intended safety function may not be available.</p> <p>STO will be activated while the motor is rotating, which is not the normal operation. Therefore, the user must ensure it is safe to do this test using an appropriate risk assessment and taking any additional risk reduction measures.</p>	

The following steps must be performed and recorded during a comprehensive check:

STO Test Step	Test Check or Activity	Expected Reaction & Effect
Initial Check (Basic Inverter Functionality)		
1	Firstly, ensure that no harm can come to personnel or equipment if the motor turns.	None.
2	Apply +24Vdc to the inverter control board terminals STOA and STOB, and 0V to the STO 0V terminal.	None.
3	Switch on power to the inverter.	No error must be present in the drive system.
4	Configure the inverter and associated equipment if necessary, so that it can be started and stopped, and responds to a speed setpoint provided.	No error must be present in the drive system.
5	Try to start the inverter with a non-zero setpoint. This setpoint value will be referred to as SPT1 for brevity in these tests. Leave this set throughout all tests.	Inverter must start and the motor must turn at SPT1.

STO Test Step	Test Check or Activity	Expected Reaction & Effect
<b>STO Channel A Check</b>		
6	With the inverter running and the motor turning at SPT1, momentarily disconnect terminal STOA (maximum duration of disconnect = 1 second), while retaining +24V at terminal STOB.	Motor must immediately coast to a rest. Inverter must report a STO trip immediately.
7	Ensure terminals STOA and STOB are both 24V. Try to restart the drive.	STO trip must clear. Inverter must restart at SPT1.
<b>STO Channel B Check</b>		
8	With the inverter running and the motor turning at SPT1, momentarily disconnect terminal STOB (maximum duration of disconnect = 1 second), while retaining +24V at terminal STOA.	Motor must immediately coast to a rest. Inverter must report a STO trip immediately.
9	Ensure terminals STOA and STOB are both 24V. Try to restart the drive.	STO trip must clear. Inverter must restart at SPT1.
<b>STO Channel A Fault Check</b>		
10	Ensure the inverter is running and that the motor is turning at SPT1. Disconnect terminal STOA for approximately 5 seconds (must exceed 3 seconds).	Motor must immediately coast to a rest. Inverter must report a STO trip immediately.
11	The STO function has latched in hardware to disable the drive. Re-apply 24V to terminal STOA, and then try to restart inverter.	STO trip must not clear. Inverter must not start.
12	Remove and re-apply all power to the drive	None.
13	Try to restart inverter at SPT1.	Inverter must start at SPT1.
<b>STO Channel B Fault Check</b>		
14	Ensure the inverter is running and that the motor is turning at SPT1. Disconnect terminal STOB for approximately 5 seconds (must exceed 3 seconds).	Motor must immediately coast to a rest. Inverter must report a STO trip immediately.
15	The STO function has latched in hardware to disable the drive. Re-apply 24V to terminal STOB, and then try to restart inverter.	STO trip must not clear. Inverter must not start.
16	Remove and re-apply all power to the drive	None.
17	Try to restart inverter at SPT1.	Inverter must start at SPT1.
18	Stop the inverter.	Inverter must decelerate to rest.

Once the relevant safety test steps have been successfully completed, action must be taken to document the result. An example protocol specimen is provided below.

Please note that additional or alternative tests may be required depending on the Machine design.

## 8.6.2 Test Protocol Specimen

Project /  
Machine: \_\_\_\_\_

Name of Tester: \_\_\_\_\_

Reference of  
Inverter: \_\_\_\_\_

STO  
Functionality:  Successfully tested (Test steps 1 – 18)

Safe Stop 1:  Successfully tested  
 Is not used

Date of Initial  
Test: \_\_\_\_\_

Date of  
Repeated Test: \_\_\_\_\_

Signature of  
Tester: \_\_\_\_\_

Signature of  
Tester: \_\_\_\_\_

## 8.6.3 Regular Checks

A regular check is intended only to demonstrate that the STO is functional. It will not always detect the loss of a single channel, so it is therefore important for the user and/or machinery builder to determine the frequency of the comprehensive checks based on their knowledge and application of the machine.

A regular check is recommended once per week.

Where a regular check coincides with the timing of a comprehensive check, the comprehensive check must take precedence.

The following steps must be performed and recorded during a regular check:

STO Test Step	Test Check or Activity	Expected Reaction & Effect
1	Firstly, ensure that no harm can come to personnel or equipment if the motor turns.	None.
2	Apply +24Vdc to the inverter control board terminals STOA and STOB, and 0V to the STO 0V terminal.	None.
3	Switch on power to the inverter.	No error must be present in the drive system.
4	Try to start the inverter with a non-zero setpoint. This setpoint value will be referred to as SPT1 for brevity in these tests. Leave this set throughout all tests.	Inverter must start and the motor must turn at SPT1.
5	With the inverter running and the motor turning at SPT1, disconnect terminal STOA and STOB within 1 second of one another. Leave both disconnected for approximately 5 seconds.	Motor must immediately coast to a rest. Inverter must report a STO trip immediately.

STO Test Step	Test Check or Activity	Expected Reaction & Effect
6	Reapply +24V to terminals STOA and STOB and acknowledge the STO trip.	STO trip must clear.
7	Try to restart the inverter at SPT1.	Inverter must restart at SPT1.
8	Stop the inverter.	Inverter must decelerate to rest.

This test can also be automated - where the STO channels can be triggered via contacts of an external relay.

## 8.7 STO Troubleshooting

The table below is for guidance only and may not be a comprehensive list of all possible symptoms relating to STO.

Parker will not accept responsibility for any consequences arising from its incompleteness or inaccuracy.







Problem	AC20 Display	STO Input Channel A wrt 0V	STO Input Channel B wrt 0V	Possible Cause	Description
Inverter will not run when given a start command	Tripped: 31 Safe Torque Off	< 15.0V	< 15.0V	STO is invoked.	When safe to do so, connect STOA and STOB to a 24Vdc supply.
	Tripped: 31 Safe Torque Off	>15.0V & < 25.2V*	>15.0V & < 25.2V*	STO Fault Latch may have tripped.	Remove all power from the inverter before re-applying. If symptom persists, immediately return the inverter for repair.
	Tripped: (Any other trip 1-30 or 32-37)	>15.0V & < 25.2V*	>15.0V & < 25.2V*	Inverter has tripped, but not due to STO.	Reset the trip and remove its cause. If symptom persists, return the inverter for repair.
	Any other message	>15.0V & < 25.2V*	>15.0V & < 25.2V*	Faulty Hardware.	Return the inverter for repair.
Inverter starts unexpectedly	X	< 5.0V	< 5.0V	Faulty Hardware.	Immediately return the inverter for repair.
	X	> 5.0V	> 5.0V	STO not invoked by the user.	Use STO in accordance with the instructions documented in this chapter.
Inverter fails Comprehensive or Regular STO test	X	X	X	Faulty Hardware.	Immediately return the inverter for repair.















\*26.4V in a maximum operating ambient of 40°C





















## 9.1.2 Onboard Drive Keypad & Display Overview

Keypad Overview	
 <p>The image shows a yellow AC20 Series keypad with a green LCD display. The display shows 'VER 1.1.1' and '10A 230V PH1 F2'. Below the display is a 'Parker' logo and two status LEDs labeled 'RUN' (red) and 'REV' (green). The keypad features several buttons: a grey 'M' button, a green 'I' button, a red 'O' button, and a central grey directional pad with up and down arrows. The 'M' button is for navigation, 'I' is for run, 'O' is for stop/reset, and the directional pad is for parameter editing.</p>	
Navigation / Parameter Edit Keys	
	<p><b>MENU Key</b>            Navigation - Displays the next Menu level, or the first parameter of the current Menu.            Parameter - Allows a writable parameter to be modified (this is indicated by → appearing on the left of the bottom line).</p>
	<p><b>UP Key</b>            Navigation - Moves upwards through the list of parameters.            Parameter - Increments the value of the displayed parameter.            Press at the same time as the '<b>STOP</b>' key to select forward direction when in '<b>Local</b>' mode.</p>
	<p><b>DOWN Key</b>            Navigation - Moves downwards through the list of parameters.            Parameter - Decrements the value of the displayed parameter.            Press at the same time as the '<b>STOP</b>' key to select reverse direction when in '<b>Local</b>' mode.</p>
	<p><b>ESCAPE Key</b>            Navigation - Displays the previous level's Menu.            Parameter - Returns to the parameter list.            Trip Acknowledge - Acknowledges displayed Trip or Error message.</p>
Local Mode Operating Keys	
	<p><b>RUN Key</b>            Control - Runs the motor at a speed determined by the LOCAL SETPOINT.            Trip Reset - Resets any trips and then runs the motor as above. Only operates when the Inverter is in '<b>Local</b>' Start/Stop (Seq) mode.</p>
	<p><b>STOP / RESET Key</b>            Control - Stops the motor. Only operates when the Inverter is in '<b>Local</b>' Sequence mode.            Trip Reset - Resets any trips and clears displayed message if trip is no longer active.            Press and hold for approx. 3 seconds to toggle between '<b>Local</b>' &amp; '<b>Remote</b>' modes of operation.            Press simultaneously with '<b>UP</b>' or '<b>DOWN</b>' key to change direction when in '<b>Local</b>' mode.</p>

Status Indicator LEDs			
	<b>'REV' LED</b>	<b>'RUN' LED</b>	<b>Inverter Status</b>
			Inverter RUNNING in FORWARDS direction.
			Inverter STOPPING from FORWARDS direction.
			Inverter RUNNING in REVERSE direction.
			Inverter STOPPING from REVERSE direction.
			Inverter STOPPED.
	<b>'OK' LED</b>	<b>Inverter Status</b>	
		Inverter is HEALTHY.	
		Inverter has TRIPPED.	

### 9.1.3 6901 Remote Keypad & Display Overview

6901 Keypad Overview	
	
Navigation / Parameter Edit Keys	
	<p><b>UP Key</b>            Navigation - Moves upwards through the list of parameters.            Parameter - Increments the value of the displayed parameter.</p>
	<p><b>DOWN Key</b>            Navigation - Moves downwards through the list of parameters.            Parameter - Decrements the value of the displayed parameter.</p>
	<p><b>ESCAPE Key</b>            Navigation - Displays the previous level's Menu.            Parameter - Returns to the parameter list.            Trip Acknowledge - Acknowledges displayed Trip or Error message.</p>
	<p><b>MENU Key</b>            Navigation - Displays the next Menu level, or the first parameter of the current Menu.            Parameter - Allows a writable parameter to be modified (this is indicated by → appearing on the left of the bottom line).</p>
	<p><b>PROGRAM Key</b>            No Function.</p>
	<p><b>LOCAL / REMOTE Mode Select Key</b>            Control - Toggles between Remote and Local Control for both Start/Stop (Seq) and Speed Control (Ref).            When toggling, the display automatically goes to the relevant SETPOINT screen, and the SETPOINT (LOCAL) screen will have the ▲ and ▼ keys enabled to alter the setpoint.</p>
Local Mode Operating Keys	
	<p><b>RUN Key</b>            Control - Runs the motor at a speed determined by the LOCAL SETPOINT.            Trip Reset - Resets any trips and then runs the motor as above. Only operates when the Inverter is in Local Start/Stop (Seq) mode.</p>
	<p><b>DIRECTION Key</b>            Control - Changes the direction of motor rotation. Only operates when the Inverter is in Local Speed Control mode.</p>

	<p><b>JOG Key</b> Control - Runs the motor at a speed determined by the JOG SETPOINT parameter. When the key is released, the Inverter returns to the "STOPPED" state. Only operates when the inverter is "STOPPED", and in Local Start/Stop mode.</p>																																								
	<p><b>STOP / RESET Key</b> Control - Stops the motor. Only operates when the Inverter is in Local Sequence mode. Trip Reset - Resets any trips and clears displayed message if trip is no longer active.</p>																																								
<b>Status Indicator LEDs</b>																																									
	<table border="1"> <thead> <tr> <th>'SEQ' LED</th> <th>'REF' LED</th> <th>Inverter Status</th> </tr> </thead> <tbody> <tr> <td style="text-align: center;"></td> <td style="text-align: center;"></td> <td>Start/Stop (Seq) and Speed Control (Ref) are controlled from the inverter terminals.</td> </tr> <tr> <td style="text-align: center;"></td> <td style="text-align: center;"></td> <td>Start/Stop (Seq) is controlled using the RUN, STOP, JOG and FWD/REV keys. Speed Control (Ref) is controlled from the inverter terminals.</td> </tr> <tr> <td style="text-align: center;"></td> <td style="text-align: center;"></td> <td>Start/Stop (Seq) is controlled from the terminals</td> </tr> <tr> <td style="text-align: center;"></td> <td style="text-align: center;"></td> <td>Speed Control (Ref) is controlled using the up (▲) and down (▼) keys</td> </tr> </tbody> </table>	'SEQ' LED	'REF' LED	Inverter Status			Start/Stop (Seq) and Speed Control (Ref) are controlled from the inverter terminals.			Start/Stop (Seq) is controlled using the RUN, STOP, JOG and FWD/REV keys. Speed Control (Ref) is controlled from the inverter terminals.			Start/Stop (Seq) is controlled from the terminals			Speed Control (Ref) is controlled using the up (▲) and down (▼) keys																									
'SEQ' LED	'REF' LED	Inverter Status																																							
		Start/Stop (Seq) and Speed Control (Ref) are controlled from the inverter terminals.																																							
		Start/Stop (Seq) is controlled using the RUN, STOP, JOG and FWD/REV keys. Speed Control (Ref) is controlled from the inverter terminals.																																							
		Start/Stop (Seq) is controlled from the terminals																																							
		Speed Control (Ref) is controlled using the up (▲) and down (▼) keys																																							
  	<table border="1"> <thead> <tr> <th>'OK' LED (HEALTH)</th> <th>'I' LED (RUN)</th> <th>'O' LED (STOP)</th> <th>Inverter Status</th> </tr> </thead> <tbody> <tr> <td style="text-align: center;"></td> <td style="text-align: center;"></td> <td style="text-align: center;"></td> <td>Inverter in CONFIGURATION mode.</td> </tr> <tr> <td style="text-align: center;"></td> <td style="text-align: center;"></td> <td style="text-align: center;"></td> <td>Inverter TRIPPED.</td> </tr> <tr> <td style="text-align: center;"></td> <td style="text-align: center;"></td> <td style="text-align: center;"></td> <td>Inverter STOPPED.</td> </tr> <tr> <td style="text-align: center;"></td> <td style="text-align: center;"></td> <td style="text-align: center;"></td> <td>Inverter STOPPING.</td> </tr> <tr> <td style="text-align: center;"></td> <td style="text-align: center;"></td> <td style="text-align: center;"></td> <td>Inverter RUNNING with ZERO SPEED demand or enable false or contactor feedback false.</td> </tr> <tr> <td style="text-align: center;"></td> <td style="text-align: center;"></td> <td style="text-align: center;"></td> <td>Inverter RUNNING.</td> </tr> <tr> <td style="text-align: center;"></td> <td style="text-align: center;"></td> <td style="text-align: center;"></td> <td>Inverter performing an AUTOTUNE routine.</td> </tr> <tr> <td style="text-align: center;"></td> <td style="text-align: center;"></td> <td style="text-align: center;"></td> <td>Inverter awaiting AUTO RESTARTING, waiting for TRIP cause to clear.</td> </tr> <tr> <td style="text-align: center;"></td> <td style="text-align: center;"></td> <td style="text-align: center;"></td> <td>Inverter AUTO RESTARTING.</td> </tr> </tbody> </table>	'OK' LED (HEALTH)	'I' LED (RUN)	'O' LED (STOP)	Inverter Status				Inverter in CONFIGURATION mode.				Inverter TRIPPED.				Inverter STOPPED.				Inverter STOPPING.				Inverter RUNNING with ZERO SPEED demand or enable false or contactor feedback false.				Inverter RUNNING.				Inverter performing an AUTOTUNE routine.				Inverter awaiting AUTO RESTARTING, waiting for TRIP cause to clear.				Inverter AUTO RESTARTING.
'OK' LED (HEALTH)	'I' LED (RUN)	'O' LED (STOP)	Inverter Status																																						
			Inverter in CONFIGURATION mode.																																						
			Inverter TRIPPED.																																						
			Inverter STOPPED.																																						
			Inverter STOPPING.																																						
			Inverter RUNNING with ZERO SPEED demand or enable false or contactor feedback false.																																						
			Inverter RUNNING.																																						
			Inverter performing an AUTOTUNE routine.																																						
			Inverter awaiting AUTO RESTARTING, waiting for TRIP cause to clear.																																						
			Inverter AUTO RESTARTING.																																						
 	<table border="1"> <thead> <tr> <th>'◀' LED (REV)</th> <th>'▶' LED (FWD)</th> <th>Inverter Status</th> </tr> </thead> <tbody> <tr> <td style="text-align: center;"></td> <td style="text-align: center;"></td> <td>Inverter RUNNING. Requested direction and actual direction are forward.</td> </tr> <tr> <td style="text-align: center;"></td> <td style="text-align: center;"></td> <td>Inverter RUNNING. Requested direction and actual direction are reverse.</td> </tr> <tr> <td style="text-align: center;"></td> <td style="text-align: center;"></td> <td>Inverter RUNNING. Requested direction is forward but actual direction is reverse.</td> </tr> <tr> <td style="text-align: center;"></td> <td style="text-align: center;"></td> <td>Inverter RUNNING. Requested direction is reverse but actual direction is forward.</td> </tr> </tbody> </table>	'◀' LED (REV)	'▶' LED (FWD)	Inverter Status			Inverter RUNNING. Requested direction and actual direction are forward.			Inverter RUNNING. Requested direction and actual direction are reverse.			Inverter RUNNING. Requested direction is forward but actual direction is reverse.			Inverter RUNNING. Requested direction is reverse but actual direction is forward.																									
'◀' LED (REV)	'▶' LED (FWD)	Inverter Status																																							
		Inverter RUNNING. Requested direction and actual direction are forward.																																							
		Inverter RUNNING. Requested direction and actual direction are reverse.																																							
		Inverter RUNNING. Requested direction is forward but actual direction is reverse.																																							
		Inverter RUNNING. Requested direction is reverse but actual direction is forward.																																							

### 9.1.4 Keypad Menu Navigation Examples

Below are some examples of how the keypad keys are used to navigate through the sub-menu lists:

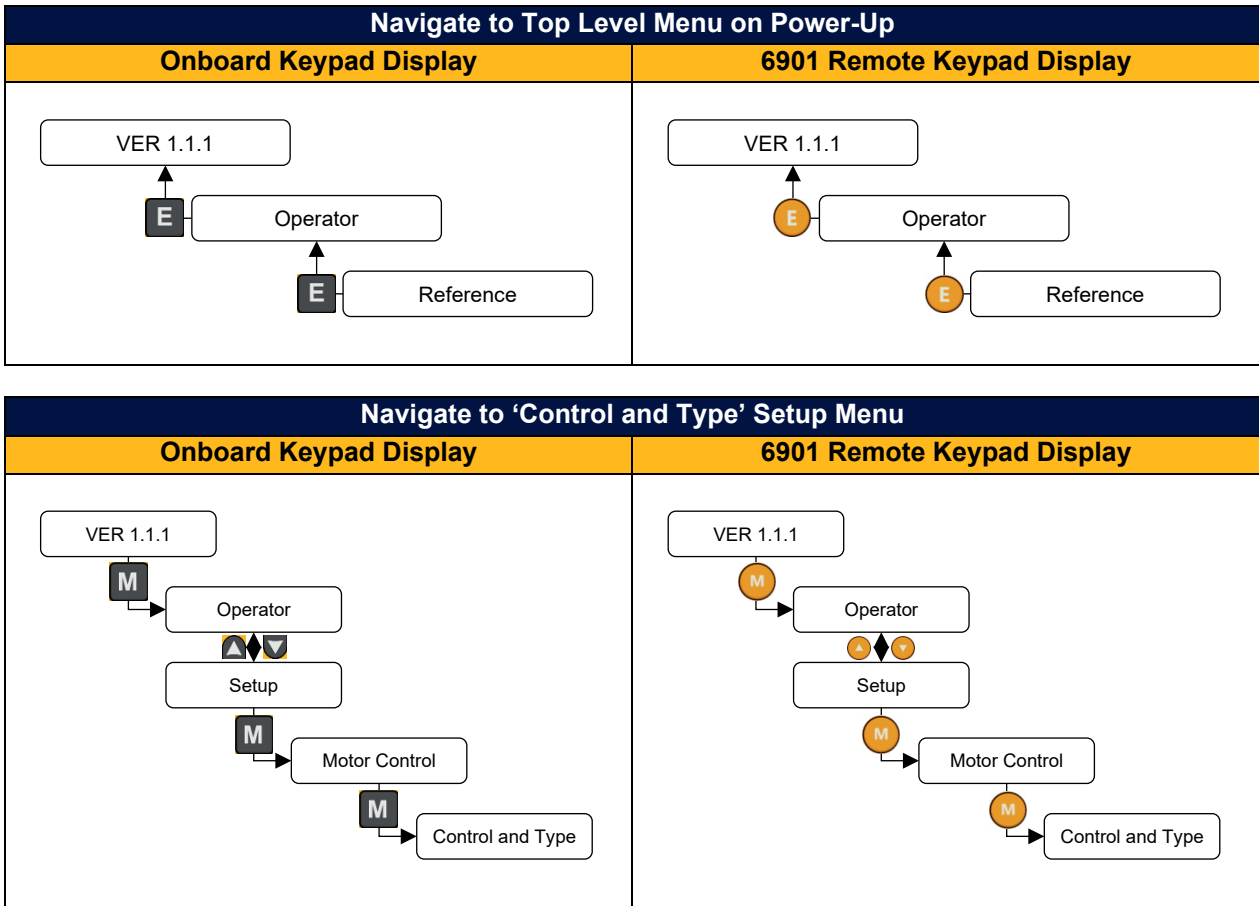



### 9.1.5 Basic Drive Setup

With the drive now wired, power can be applied.

Once powered up with the drive display illuminated, the following steps need to be completed by navigating through either the onboard or 6901 remote keypad, before running the drive:

1. Initial Drive Setup:
  - Control Strategy: set the motor type and control strategy.
  - Motor Nameplate: enter the motor nameplate information.
  - Encoder: enter the encoder information (Sensorless: Encoder Feedback control with an Induction Motor only).
2. Local Control:
  - Enable 'Local' Control Mode: to run the drive from either the onboard or remote keypad.
  - 'Autotune' routine: only required if 'Vector Control' Strategy is selected.
  - Run the drive: set a speed setpoint and issue a drive run command to rotate the motor.
  - Stop the drive: bring the motor back to a standstill.
  - Change the motor direction: to run the motor in reverse.

**Note: By default, parameter value changes are saved automatically. Refer to the 'AC20 Series Software Reference Manual' (DOC-0017-13) for details.**

#### Initial Drive Setup

On drive power-up:

- The displays (both Onboard and Remote), will revert to the 'Operator' menu. Press the 'E' key two times to exit to the top menu level, so "VER x.x.x" is shown on the display (where 'x.x.x' is firmware version).

#### 1. Control Strategy Settings:

To setup the drives 'Motor Type' and 'Control Strategy':

- Navigate to the 'Setup' menu:

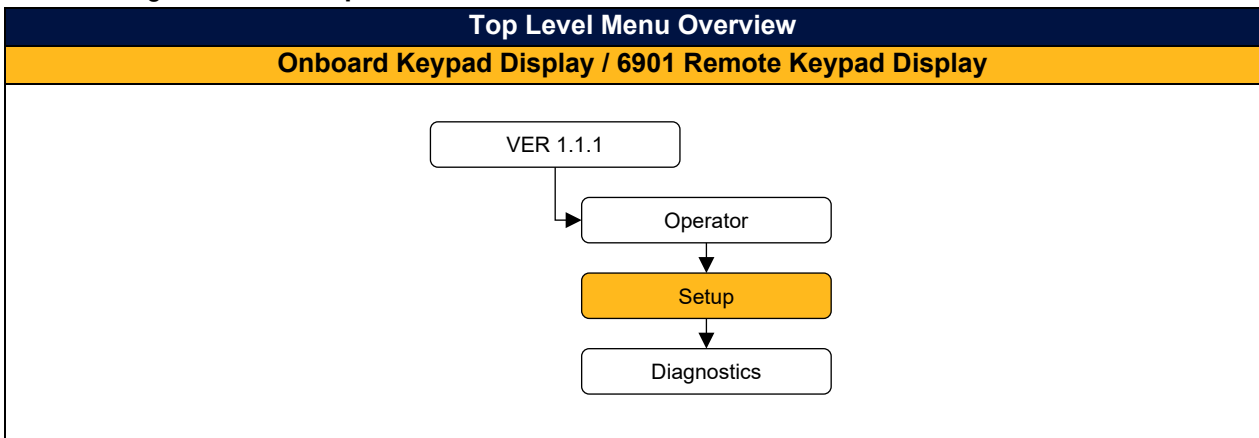

- Navigate to the 'Control and Type' sub-menu:

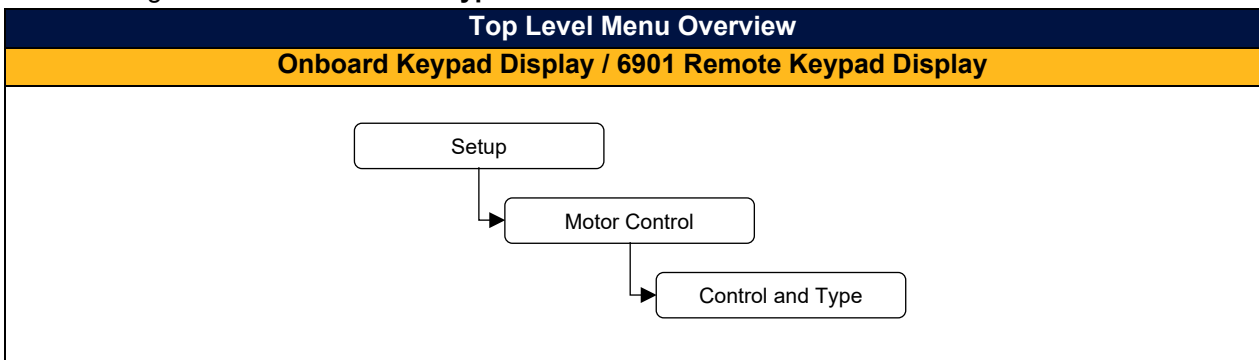

**Note:** The parameters displayed in this list will vary depending on what settings have been selected i.e., 'Motor Type' & 'Control Strategy' parameters.

- Enter values as required ('key' parameters listed below only):

Parameter Name	No.	Default Value	Range	Units	Type	Writable
Thermistor Type	0892	0: PTC	0: PTC 1: NTC		ENUM	ALWAYS
Motor Type	0030	0: Induction Motor	0: Induction motor 1: PMAC Motor		ENUM	STOPPED
Control Strategy	0031	0: Volts-Hertz Control	0: Volts-Hertz Control 1: Vector Control		ENUM	STOPPED
Control Type	0032	0: Sensorless	0: Sensorless 1: Encoder Feedback		ENUM	STOPPED
Encoder Feedback	0033	0: SLOT1	0: SLOT1 1: SLOT2		ENUM	STOPPED

## 2. Motor Nameplate Settings:

### a) Induction Motor

To enter the 'Motor Nameplate' information for an Induction Motor:

- Navigate to the 'Motor Nameplate' sub-menu:

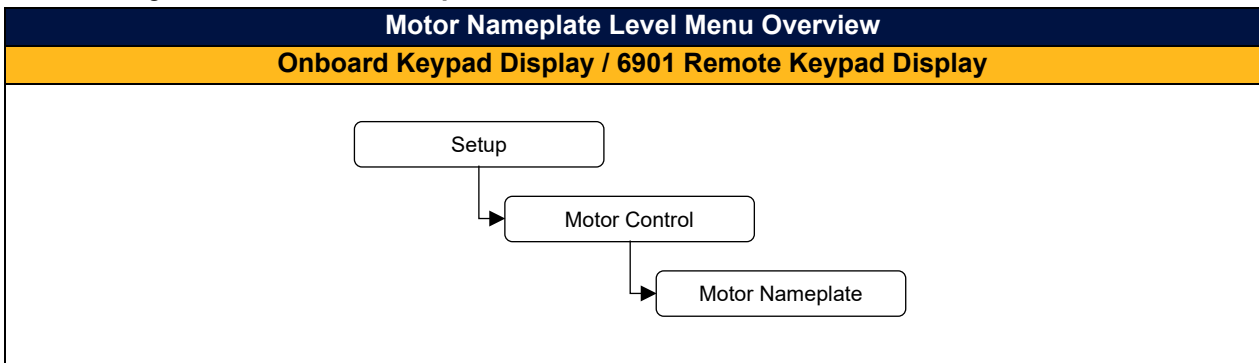

- Enter values as required:

Parameter Name	No.	Default Value	Range	Units	Type	Writable
Base Frequency	0224	50	1 to 1000	Hz	REAL	STOPPED
Base Voltage	0223	400.00	1 to 1000	V	REAL	STOPPED
Nameplate Speed	0226	1450	0 to 100000	rpm	REAL	STOPPED
Motor Power	0227	0.75	0 to 3000	kW	REAL	STOPPED
Power Factor	0228	0.71	0 to 1		REAL	STOPPED
Rated Current	0222	1.56	0.05 to 10000.0	A	REAL	STOPPED
IM Wiring	0182	0: FALSE	0: FALSE 1: TRUE		BOOL	STOPPED

**Note:** Setting 'IM Wiring' to 'TRUE' electronically swaps phases V & W - inverting motor direction.

**b) PMAC Motor**

To enter the 'Motor Data PMAC' information for a PMAC Motor:

- Navigate to the 'Motor Data PMAC' sub-menu:

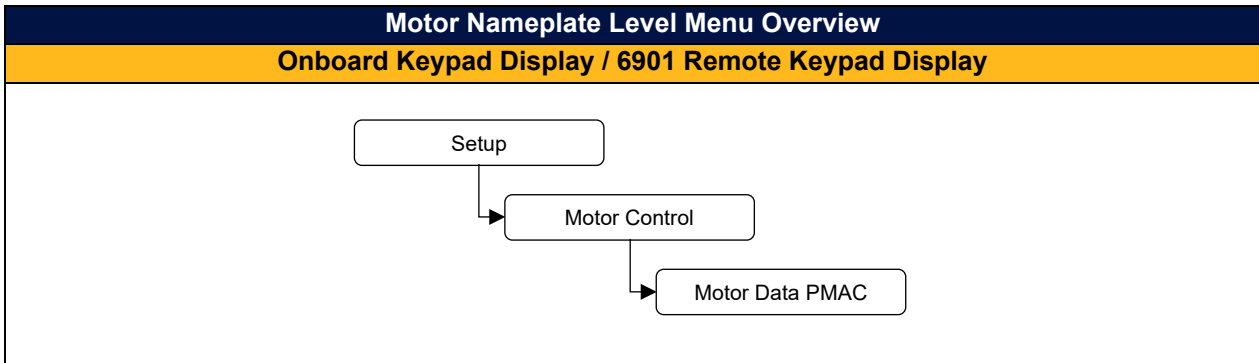

- Enter values as required:

Parameter Name	No.	Default Value	Range	Units	Type	Writable
PMAC Back EMF Ke	0284	60.0	0.1 to 30000.0	V	REAL	ALWAYS
PMAC Base Volt	0290	400.00	1 to 1000	V	REAL	ALWAYS
PMAC Max Speed	0279	3000	1.0 to 100000.0	rpm	REAL	ALWAYS
PMAC Max Current	0280	4.50	0.05 to 5000	A	REAL	ALWAYS
PMAC Mot Inertia	0268	0.0010	0.0010 to 100.0	kgm <sup>2</sup>	REAL	ALWAYS
PMAC Motor Poles	0283	10	2 to 400		UINT	ALWAYS
PMAC Rated Cur	0281	4.50	0.05 to 5000	A	REAL	ALWAYS
PMAC Rated Torq	0282	4.50	0.01 to 30000.0	Nm	REAL	ALWAYS
PMAC Therm TC	0289	62	1 to 10000	s	TIME	ALWAYS
PMAC Torque KT	0287	1.00	0.01 to 10000.0	Nm/A	REAL	ALWAYS
PMAC Winding Ind	0286	20.00	0.01 to 1000.0	mH	REAL	ALWAYS
PMAC Winding Res	0285	6.580	0.001 to 500.0	Ohm	REAL	ALWAYS
PMAC Wiring	0291	0: Standard	0: Standard 1: Reverse		ENUM	ALWAYS

**Note:** Setting 'PMAC Wiring' to 'Reverse' electronically swaps phases V & W - inverting motor direction.

**3. Encoder Settings:**

If the 'Control Strategy' is set to 'Vector Control', and the 'Control Type' is set to 'Encoder Feedback' (Induction Motor only), the encoder mounted on the motor will also need to be set up.

If only one Encoder Feedback option card is fitted, the AC20 will automatically detect which slot the Encoder Feedback card is fitted to.

If two Encoder Feedback option cards are fitted, the 'Encoder Feedback' parameter (0033) in the 'Control and Type' menu needs to be set to indicate which slot is to be used for the speed feedback.

**Note:** See Section 6.3.3 for wiring example.

To enter the 'Encoder' information:

- Navigate to the 'Encoder' (if option fitted in slot 1), or 'Encoder 2' (if option fitted in slot 2) sub-menu:

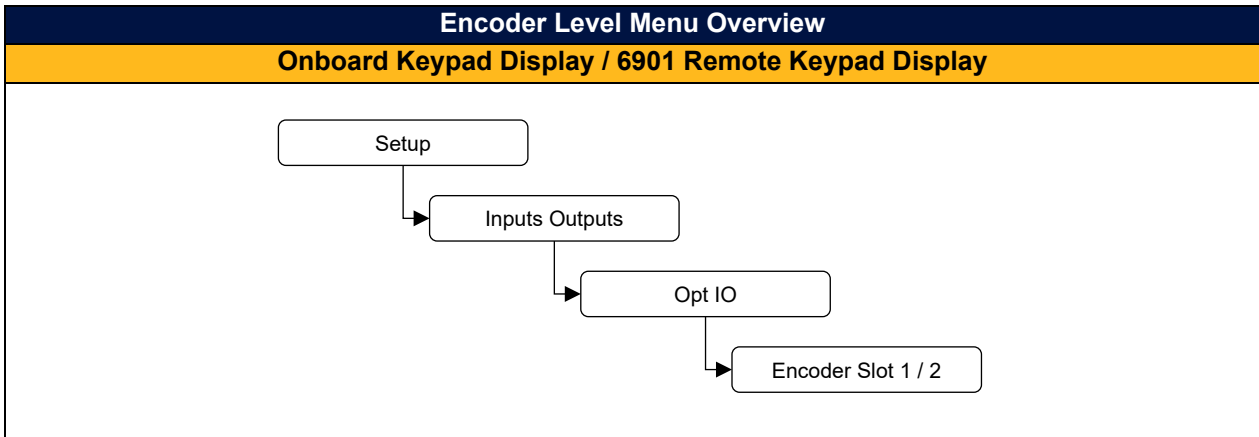



- Enter values as required ('Encoder' parameter list shown for illustration):

Parameter Name	No.	Default Value	Range	Units	Type	Writable
Enc CountReset	0073	0: FALSE	0: FALSE 1: TRUE		BOOL	ALWAYS
Enc Invert	0074	0: FALSE	0: FALSE 1: TRUE		BOOL	STOPPED
Enc Lines	0075	100	1 to 65535		UINT	STOPPED
Enc Mode	0078	0: Quadrature	0: Quadrature 1: Clock & Dir 2: Clock		ENUM	STOPPED
Enc Supply	0076	0: 5V	0: 5 V 1: 12 V 2: 15 V 3: 20 V		ENUM	STOPPED
Enc Threshold	0077	0: Low	0: Low 1: High		ENUM	STOPPED
Enc Position	0081	0	-2147483648 to 2147483648		DINT	NOT

### 'Local' Operation

#### 1. Enable 'Local' Control Mode:

To enable 'Local' Control Mode:

Local Control Mode Selection	
Onboard Keypad Display	6901 Remote Keypad Display
 <p>Press and hold the 'Stop' key for approx. 3 seconds as "REMOTE ... TO ... LOCAL" appears across the display.</p>	 <p>Press the 'L/R' key.</p>

Once 'Local' Control Mode is enabled, the drive will show the following status indication:

Local Control Mode 'Enabled'	
Onboard Keypad Display	6901 Remote Keypad Display
No indication displayed.	 <p>The 'SEQ' &amp; 'REF' LEDs will illuminate.</p>

**2. 'Autotune' Routine ('Vector Control' Strategy Only):**

If the drive 'Control Strategy', has been set to 'Vector Control' (either 'Sensorless' or 'Encoder Feedback', an 'Autotune' routine will need to be performed prior to running the drive. This is required for the drive to calculate and model the motor parameters (i.e., Magnetising Current, Rotor Time Constant, Stator Resistance, Mutual & Leakage Inductances) for better speed and torque control. Failure to perform an 'Autotune' routine will result in poor motor control, or most likely spurious drive trips when enabled.

There are two types of 'Autotune' routine:

1. Rotating
2. Stationary

A 'Rotating' autotune on an uncoupled motor is always the preferred autotune 'Type' whenever possible. If this is not practical, a 'Stationary' routine is possible where the motor shaft will not rotate. However, the result is usually lower dynamic performance.

To perform an 'Autotune' routine:

- Navigate to the 'Autotune' sub-menu:

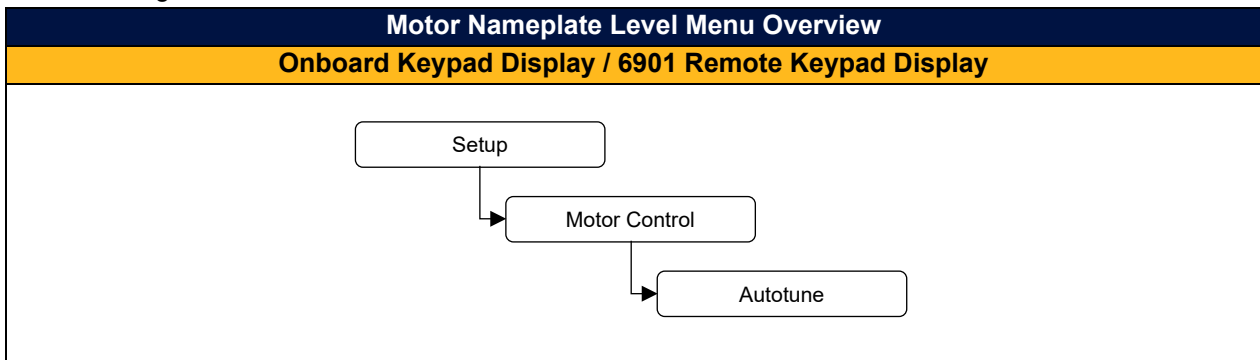



- The 'Atn Mode' is set to 'Rotating' by default (recommended), but if this is not possible, change it to 'Stationary'.
- Next, set the 'Atn Enable' to 'TRUE'.



Parameter Name	No.	Default Value	Range	Units	Type	Writable
Atn Mode	0036	1: Rotating	0: Stationary 1: Rotating		ENUM	STOPPED
Atn Enable	0035	0: FALSE	0: FALSE 1: TRUE		BOOL	STOPPED

To start the 'Autotune' routine:

- Press the 'Run' key:

Local 'Run' Enable	
Onboard Keypad Display	6901 Remote Keypad Display
	

- The drive should run through a pre-determined routine.
- When the 'Autotune' routine is running, the drive will show the following status indication:

Drive 'Running' Indication	
Onboard Keypad Display	6901 Remote Keypad Display
 <p>'RUN' LED will flash and "Autotune IN PROGRESS" text is displayed.</p>	 <p>Motor 'Running' &amp; 'Stopped' LEDs will flash and "Autotune IN PROGRESS" text is displayed.</p>

- At the end of the 'Autotune' routine, the motor will decelerate to a stop and the drive will disable:

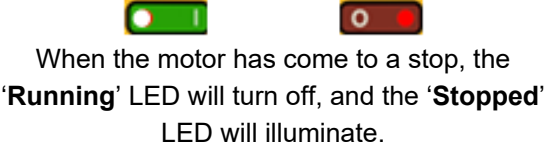
Drive 'Stopped' Indication	
Onboard Keypad Display	6901 Remote Keypad Display
 <p>'RUN' LED will flash until the motor has come to a stop.</p>	 <p>When the motor has come to a stop, the 'Running' LED will turn off, and the 'Stopped' LED will illuminate.</p>

- The drive is now ready to run in 'Vector Control' mode.

### 3. Running The Drive:

To run the drive:

- Navigate to the 'Operator' menu:

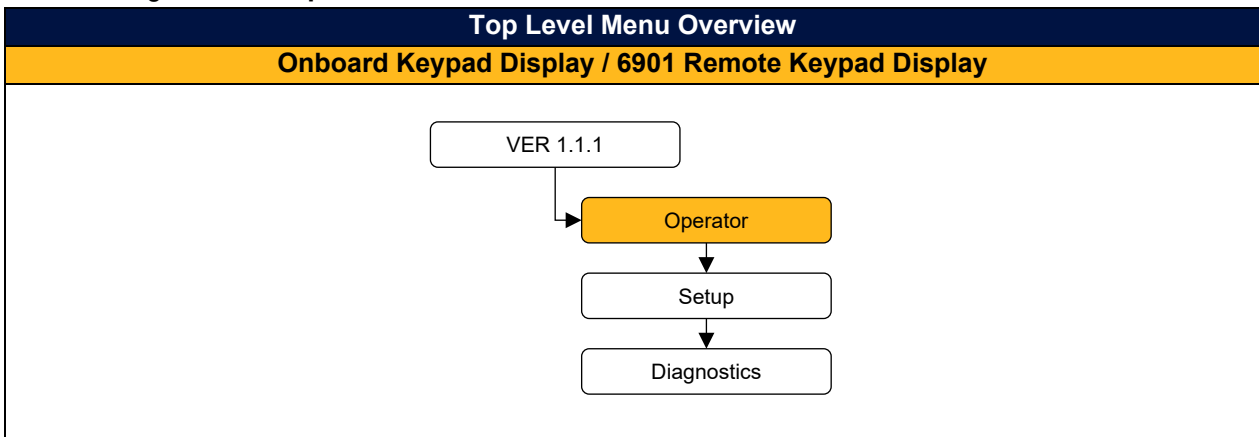

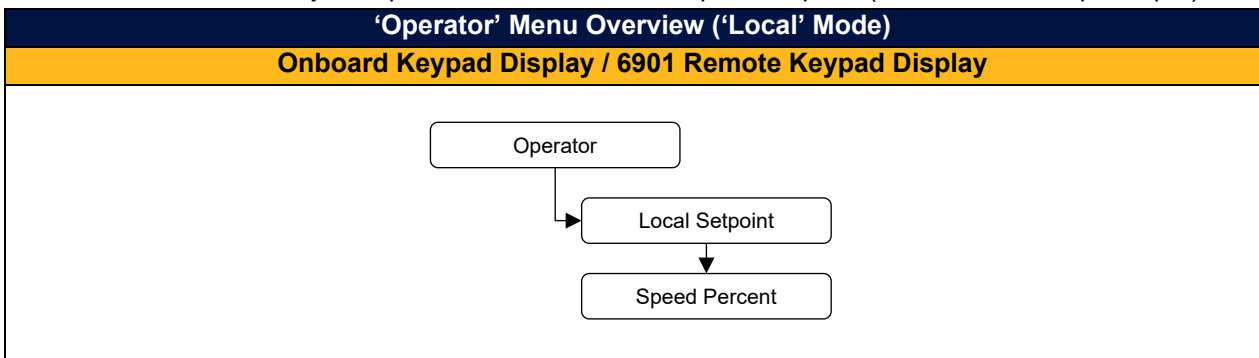

- Set the 'Local Setpoint' parameter to the desired speed setpoint (% of motor nameplate rpm):











- Press the 'Run' key:

Local 'Run' Enable	
Onboard Keypad Display	6901 Remote Keypad Display
	



- The drive will enable and should accelerate the motor to the speed demanded. The 'Speed Percent' parameter provides the real time speed feedback (% of motor nameplate rpm) value.
- When the drive is running, the drive will show the following status indication:

Drive 'Running' Indication	
Onboard Keypad Display	6901 Remote Keypad Display
 'RUN' LED Illuminates. If the 'REV' LED is also illuminated, motor is running in the reverse direction: 	 Motor 'Running' LED Illuminated, motor 'Stopped' LED off. The shaft will rotate in the direction indicated by the direction LEDs: 'FWD' direction:   'REV' direction:  





#### 4. Stopping The Drive:

To stop the drive:

- Press the 'Stop' key:

Local 'Stop' Mode Initiation	
Onboard Keypad Display	6901 Remote Keypad Display
	



The drive should decelerate the motor to a standstill, before disabling:

Drive 'Stopped' Indication	
Onboard Keypad Display	6901 Remote Keypad Display
 →  'RUN' LED will flash during motor deceleration, until the motor has come to a stop.	 →  Motor 'Stopped' LED will flash during motor deceleration, until the motor has come to a stop, when the 'Stopped' LED will illuminate.





**5. To Change Motor Direction:**

To change the direction of the motor with the onboard keypad:

- Ensure the drive is in a **'Stopped'** state:
- Press the **'Stop'** key and either the **'Up' (Forward)** or **'Down' (Reverse)** key simultaneously:

Changing Motor Direction Initiation	
Onboard Keypad Display	6901 Remote Keypad Display
 	

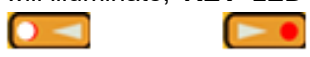
The direction is indicated by:

Motor 'Direction' Indication	
Onboard Keypad Display	6901 Remote Keypad Display
<p>If <b>'Forward'</b> direction is active:                      'REV' LED will turn off:</p>  <p>If <b>'Reverse'</b> direction is active:                      'REV' LED will illuminate:</p> 	<p>If <b>'Forward'</b> direction is active:                      'FWD' LED will illuminate, 'REV' LED will turn off:</p>  <p>If <b>'Reverse'</b> direction is active:                      'REV' LED will illuminate, 'FWD' LED will turn off:</p> 

**Note:** The direction can be changed on the Remote keypad at any time (i.e., when drive is 'Running' or is 'Stopped').



## 9.2 'Remote' Operation (Using Pre-Defined Macro's)

To run the drive 'remotely' (using either push-buttons, switches or PLC's as opposed to a keypad), the following steps need to be followed.

**Note:** This sequence assumes that the 'Basic Drive Setup' routine has been completed, as outlined above.

### 9.2.1 Enable 'Remote' Control Mode

To enable 'Remote' Control Mode:

Remote Control Mode Selection	
Onboard Keypad Display	6901 Remote Keypad Display
 <p>Press and hold the 'Stop' key for approx. 3 seconds as "LOCAL ... TO ... REMOTE" appears across the display.</p>	 <p>Press the 'L/R' key.</p>

Once 'Remote' Control Mode is enabled, the drive will show the following status indication:

Remote Control Mode 'Enabled'	
Onboard Keypad Display	6901 Remote Keypad Display
<p>No indication displayed.</p>	 <p>The 'SEQ' &amp; 'REF' LEDs will turn off.</p>

### 9.2.2 Selecting & Loading A Macro

To select and load a pre-defined Macro:

- Navigate through the 'Setup' menu, to the 'Application' sub-menu:

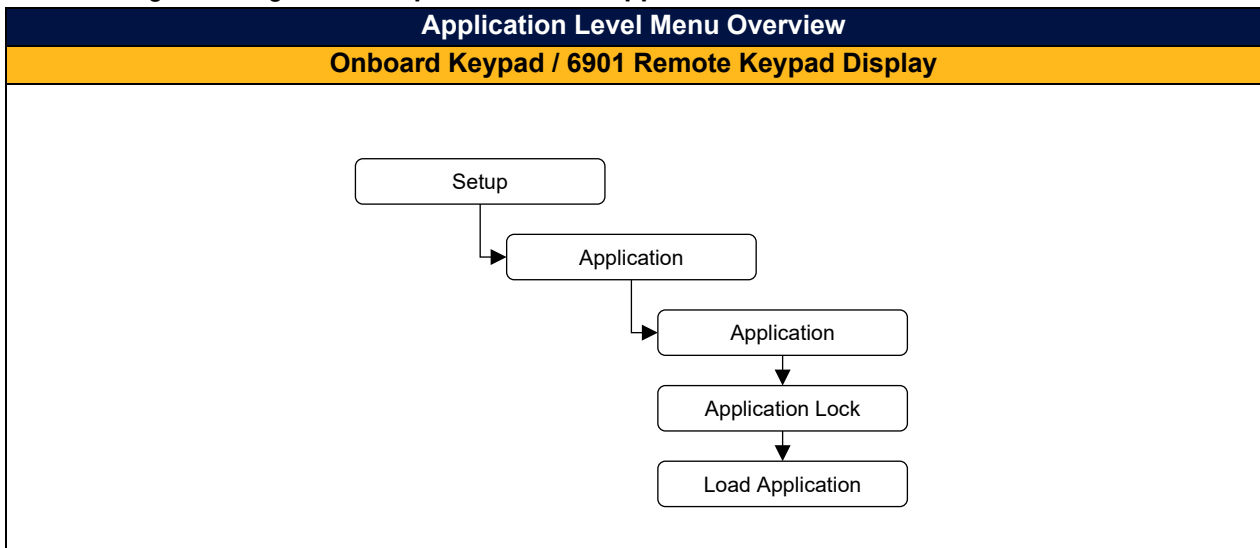

- Select an 'Application' (Macro) by changing the value of the '**Application**' parameter.
- Next, change the '**Load Application**' parameter '**FALSE**' to '**TRUE**'.

Parameter Name	No.	Default Value	Range	Units	Type	Writable
<b>Application</b>	1150	9: Saved	0: Null 1: Standard 2: Auto/Manual 3: Presets 4: Raise/Lower 5: PID 6: Aux Comms 9: Saved		ENUM	STOPPED
<b>Application Lock</b>	1152	FALSE			BOOL	ALWAYS
<b>Load Application</b>	1151	FALSE			BOOL	STOPPED

- To 'lock' the application so it can not be accidently changed, set the '**Application Lock**' parameter from '**FALSE**' to '**TRUE**'.

### 9.2.3 Running The Drive

Providing the drive is:

1. Set to '**Remote**' operating mode.
2. '**Initial Drive Setup**' has been completed.
3. An '**Autotune**' routine has been completed (if set to SVC mode).

The drive is ready to be run from the remote switches (see application examples below):

### 9.2.4 Application '1': Standard (Basic Speed Control)

This Application is ideal for general purpose applications. It provides push-button or switched start/stop control. The setpoint is the sum of the two analogue inputs AIN1 and AIN2, providing Speed Setpoint + Speed Trim capability.

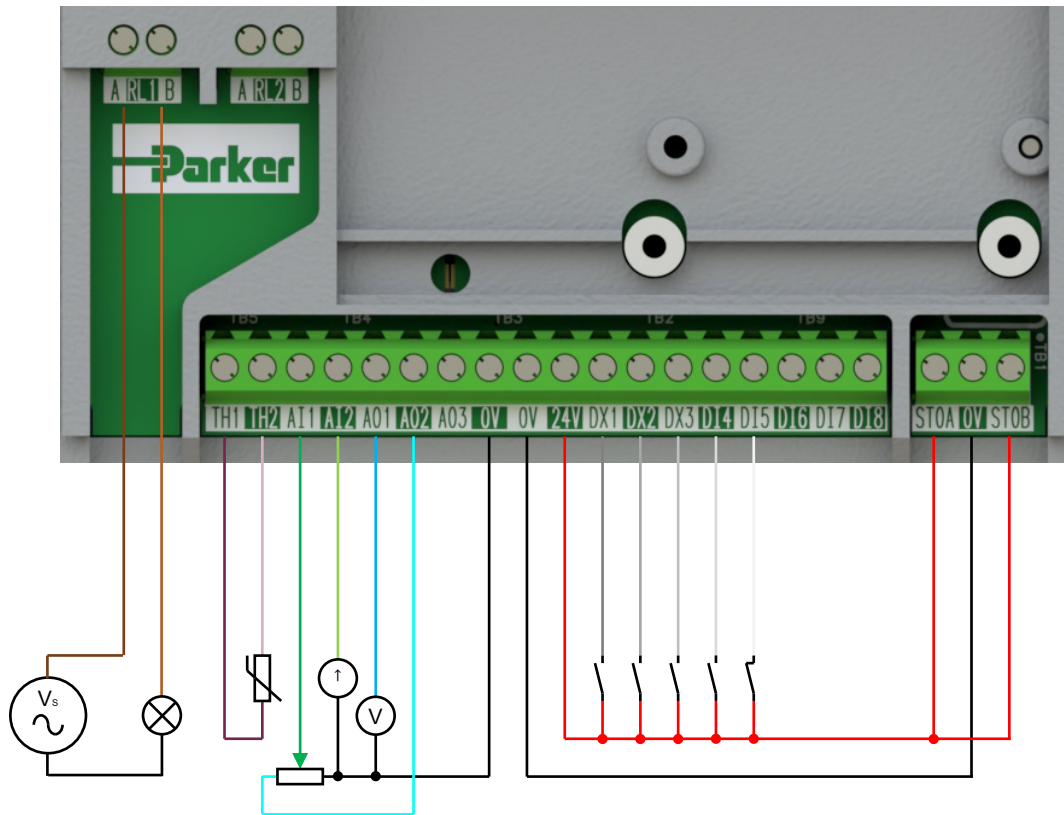

Configuration Setup:	
RL1A	110-230Vac (or 24Vdc) voltage supply
RL1B	<b>Healthy:</b> Relay output (to lamp)
TH1	Motor Thermistor '+' connection
TH2	Motor Thermistor '-' connection
AI1	<b>Remote Setpoint (%) – input 1:</b> 0-10V variable input (from potentiometer)
AI2	<b>Remote Setpoint 'Trim' (%) – input 2:</b> 4-20mA variable input (from current source)
AO1	<b>Speed Demand (%):</b> 0-10V variable output (to voltmeter)
AO2	<b>Value = 100%:</b> 0-10V variable output (+10V fixed reference voltage)
DX1	<b>Run Forward:</b> 24V digital input
DX2	<b>Remote Reverse:</b> 24V digital input
DX3	<b>Jog:</b> 24V digital input
DI4	<b>Not Stop:</b> 24V digital input
DI5	<b>Not Coast Stop:</b> 24V digital input
STO	STO <b>DISABLED</b> (drive operational)

## 9.2.5 Application '2': Auto / Manual

Two Run inputs and two Setpoint inputs are provided. The Auto/Manual switch selects which pair of inputs is active.

The Application is sometimes referred to as Local/Remote.

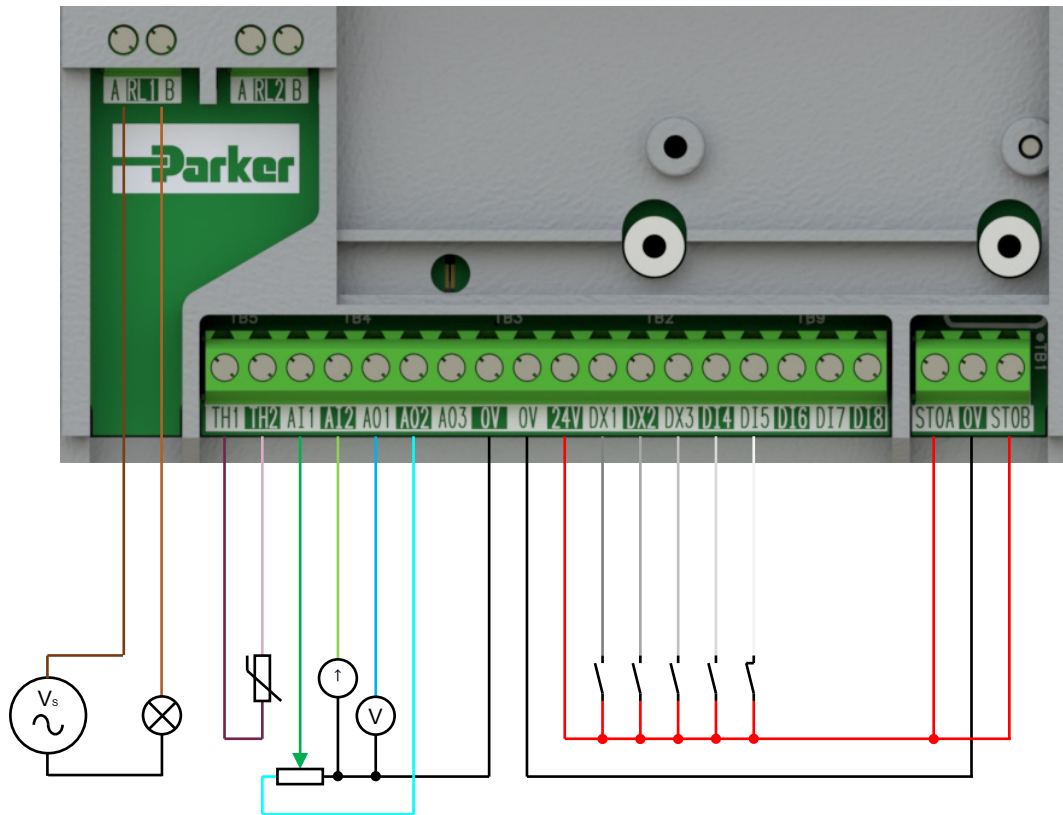

### Configuration Setup:

RL1A	110-230Vac (or 24Vdc) voltage supply
RL1B	<b>Healthy:</b> Relay output (to lamp)
TH1	Motor Thermistor '+' connection
TH2	Motor Thermistor '-' connection
AI1	<b>'Manual' Remote Setpoint (%):</b> 0-10V variable input (from potentiometer)
AI2	<b>'Auto' Remote Setpoint (%):</b> 4-20mA variable input (from current source)
AO1	<b>Speed Demand (%):</b> 0-10V variable output (to voltmeter)
AO2	<b>Value = 100%:</b> 0-10V variable output (+10V fixed reference voltage)
DX1	<b>'Manual' Run:</b> 24V digital input
DX2	<b>'Auto' Run:</b> 24V digital input
DX3	<b>Auto / Manual Select:</b> 24V digital input
DI4	<b>Remote Reverse:</b> 24V digital input
DI5	<b>Not Coast Stop:</b> 24V digital input
STO	STO <b>DISABLED</b> (drive operational)

### 9.2.6 Application '3': Presets

This is ideal for applications requiring multiple discrete speed levels.

The setpoint is selected from either the sum of the analogue inputs, (as in Application 1 and known here as PRESET 0), or as one of up to seven other pre-defined speed levels. These are selected using DIN2, DIN3 and DIN4 as per the Truth Table below:

DX2 (Preset Select 1)	DX3 (Preset Select 2)	DI4 (Preset Select 3)	Preset Setpoint No.
0V	0V	0V	0
24V	0V	0V	1
0V	24V	0V	2
24V	24V	0V	3
0V	0V	24V	4
24V	0V	24V	5
0V	24V	24V	6
24V	24V	24V	7

The keypad can be used to re-define the speed levels of the PRESET 1 to PRESET 7 setpoints. Reverse direction is achieved by entering a negative speed setpoint.

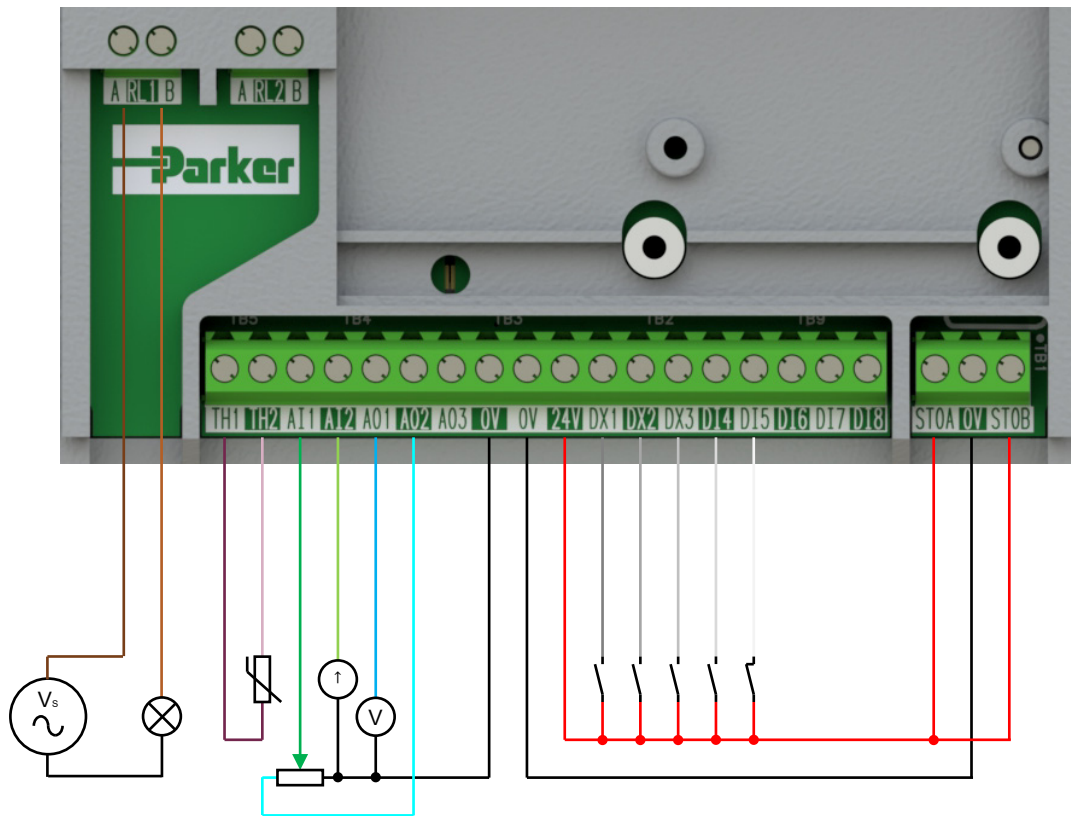

Configuration Setup:	
RL1A	110-230Vac (or 24Vdc) voltage supply
RL1B	<b>Healthy:</b> Relay output (to lamp)
TH1	Motor Thermistor '+' connection
TH2	Motor Thermistor '-' connection
AI1	<b>Remote Setpoint (%) – input 1:</b> 0-10V variable input (from potentiometer)
AI2	<b>Remote Setpoint 'Trim' (%) – input 2:</b> 4-20mA variable input (from current source)
AO1	<b>Speed Demand (%):</b> 0-10V variable output (to voltmeter)
AO2	<b>Value = 100%:</b> 0-10V variable output (+10V fixed reference voltage)
DX1	<b>Run Forward:</b> 24V digital input
DX2	<b>Preset Select 1:</b> 24V digital input
DX3	<b>Preset Select 2:</b> 24V digital input
DI4	<b>Preset Select 3:</b> 24V digital input
DI5	<b>Not Coast Stop:</b> 24V digital input
STO	STO <b>DISABLED</b> (drive operational)



### 9.2.7 Application '4': Raise / Lower

This Application mimics the operation of a motorised potentiometer. Digital inputs allow the setpoint to be increased and decreased between limits. The limits and ramp rate can be set using the keypad. The Application is sometimes referred to as Motorised Potentiometer.

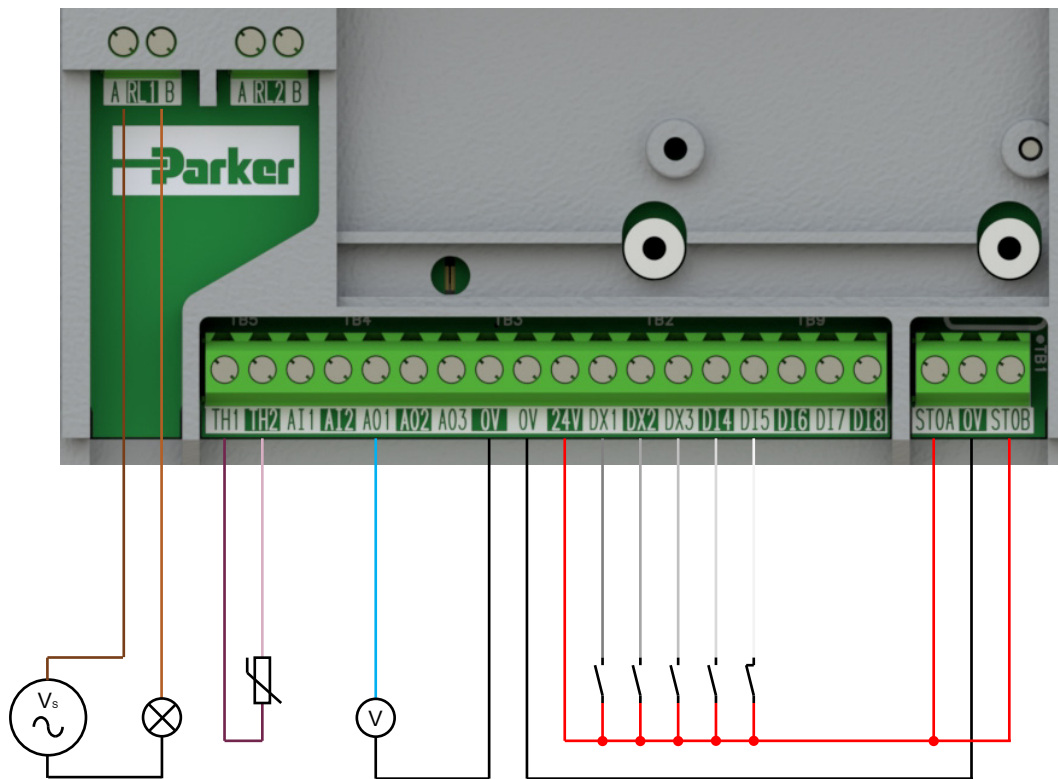

Configuration Setup:	
RL1A	110-230Vac (or 24Vdc) voltage supply
RL1B	<b>Healthy:</b> Relay output (to lamp)
TH1	Motor Thermistor '+' connection
TH2	Motor Thermistor '-' connection
AO1	<b>Speed Demand (%):</b> 0-10V variable output (to voltmeter)
DX1	<b>Run Forward:</b> 24V digital input
DX2	<b>Raise:</b> 24V digital input
DX3	<b>Lower:</b> 24V digital input
DI4	<b>Raise / Lower Reset:</b> 24V digital input
DI5	<b>Not Coast Stop:</b> 24V digital input
STO	STO <b>DISABLED</b> (drive operational)

### 9.2.8 Application '5': PID

A simple application using a Proportional-Integral-Derivative 3-term controller. The setpoint is taken from AIN1, with feedback signal from the process on AIN2. The scale and offset features of the analogue input blocks may be used to correctly scale these signals. The difference between these two signals is taken as the PID error. The output of the PID block is then used as the drive setpoint.

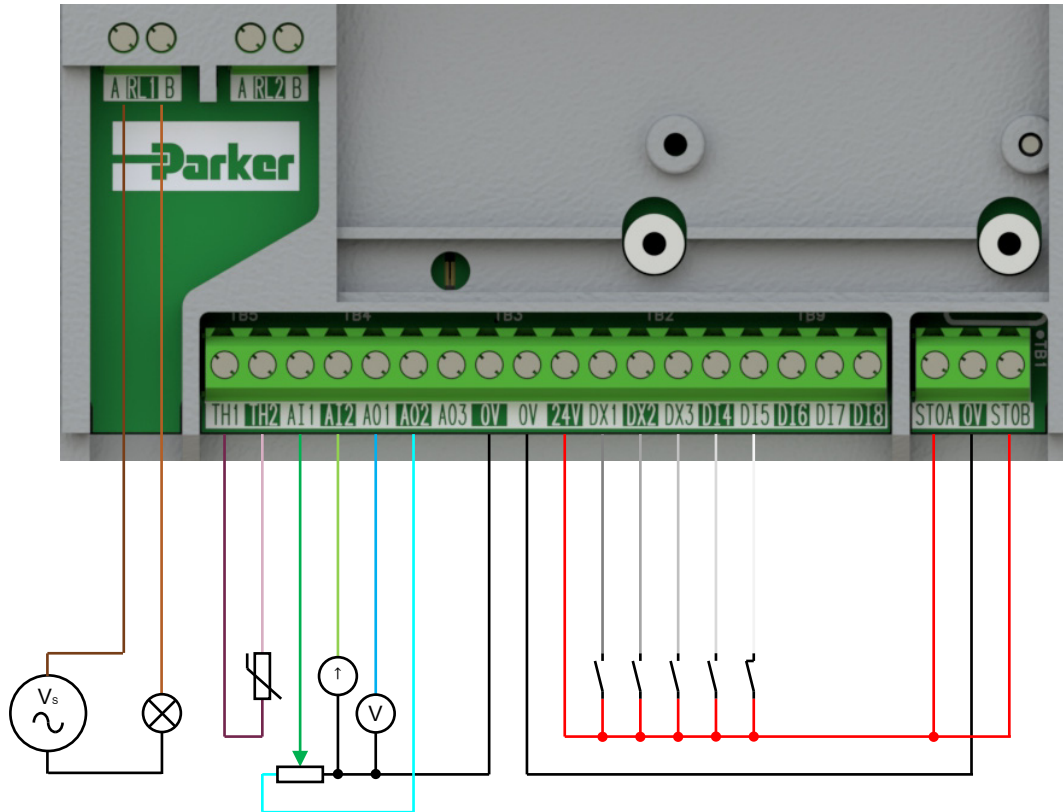

Configuration Setup:	
RL1A	110-230Vac (or 24Vdc) voltage supply
RL1B	<b>Healthy:</b> Relay output (to lamp)
TH1	Motor Thermistor '+' connection
TH2	Motor Thermistor '-' connection
AI1	<b>Process Setpoint (%) – input 1:</b> 0-10V variable input (from potentiometer)
AI2	<b>Process Feedback (%) – input 2:</b> 4-20mA variable input (from current source)
AO1	<b>Speed Demand (%):</b> 0-10V variable output (to voltmeter)
AO2	<b>Value = 100%:</b> 0-10V variable output (+10V fixed reference voltage)
DX1	<b>Run Forward:</b> 24V digital input
DX2	<b>Remote Reverse:</b> 24V digital input
DX3	<b>Jog:</b> 24V digital input
DI4	<b>Not Stop:</b> 24V digital input
DI5	<b>Not Coast Stop:</b> 24V digital input
STO	STO <b>DISABLED</b> (drive operational)

## 9.2.9 Application '6': Aux Comms

Aux Comms is designed to reproduce the Aux Comms macro/template from the legacy 650 range of drives. The default method of communications for this macro is Modbus TCP/IP, and the master controller must be configured with a mapping that connects to the points shown in red text within the DSELite template. Refer to the 'AC20 Series – Software Reference' Manual (DOC-0017-13) for instructions on configuring base Modbus TCP/IP communications.

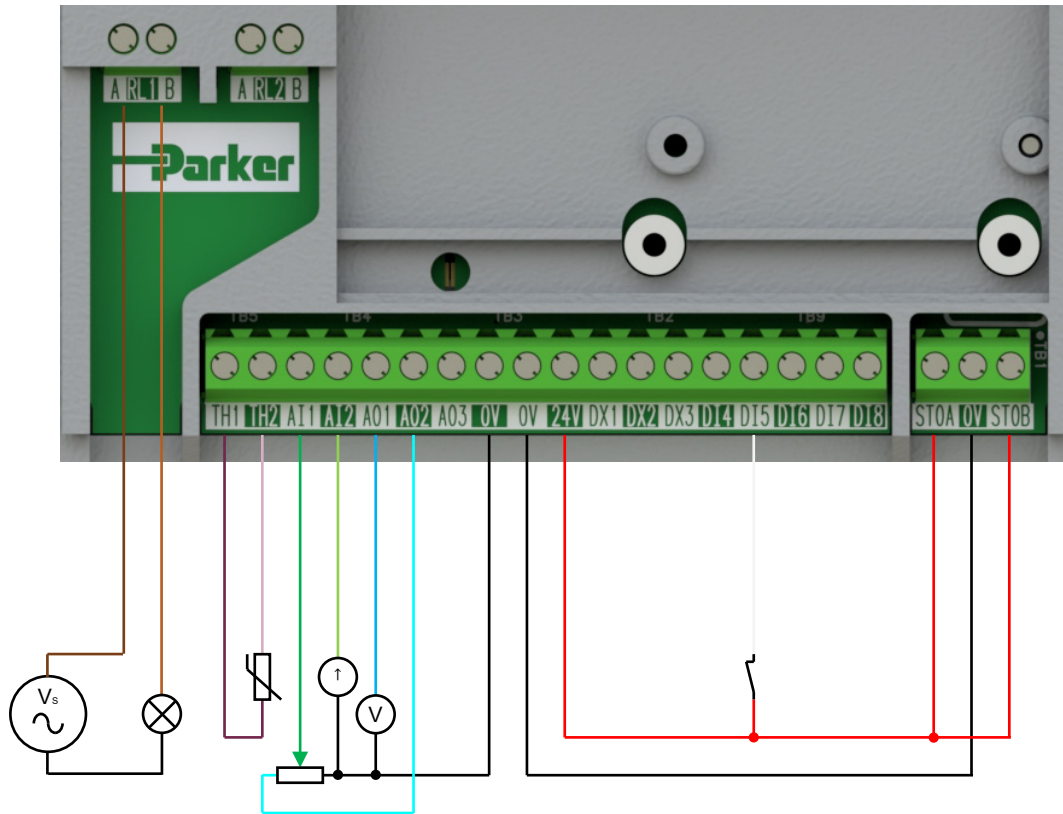

### Configuration Setup:

RL1A	110-230Vac (or 24Vdc) voltage supply
RL1B	<b>Healthy:</b> Relay output (to lamp)
TH1	Motor Thermistor '+' connection
TH2	Motor Thermistor '-' connection
AI1	<b>Remote Setpoint (%) – input 1:</b> 0-10V variable input (from potentiometer)
AI2	<b>Remote Setpoint 'Trim' (%) – input 2:</b> 4-20mA variable input (from current source)
AO1	<b>Speed Demand (%):</b> 0-10V variable output (to voltmeter)
AO2	<b>Value = 100%:</b> 0-10V variable output (+10V fixed reference voltage)
DI5	<b>Not Coast Stop:</b> 24V digital input
STO	STO <b>DISABLED</b> (drive operational)

### 9.3 External +24V Power-Up Mode

Allows for the partial power-up of the product without mains power applied, for programming of the drive using the DSELite programming tool through the Ethernet port, or communication with the drive through the Anybus Comms option.  $\mu$ SD Card port, display, keypads and digital I/O are also active. The external power supply is connected as per the diagram below:

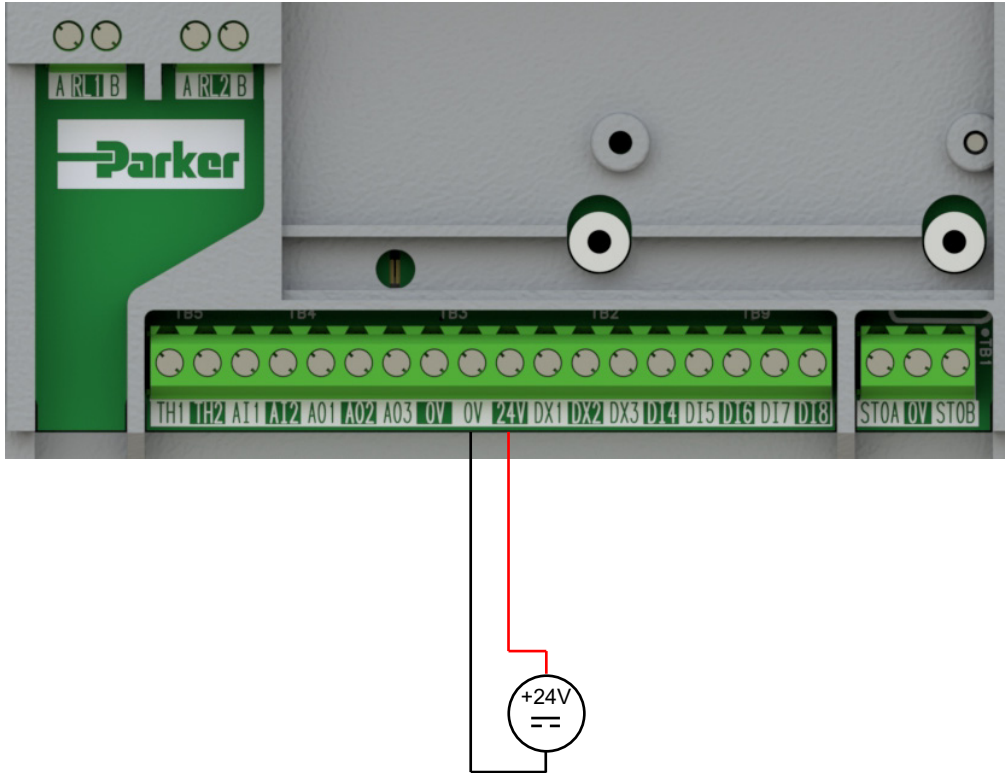

#### 9.3.1 24V Active Functionality

Although in 24V power-up mode the drive cannot run a motor, a limited number of circuits and functions are still active, as summarised in the table below:

Product Function	Frame 2 - 5	Frame 6 - 10
On-board Display	✓	✓
On-board Keypad	✓	✓
Status LEDs	✓	✓
P3 Port (6901 Remote Keypad)	✓	✓
Ethernet Port	✓	✓
$\mu$ SD Card Slot	✓	✓
Analogue Inputs	✗	✗
Analogue Outputs	✗	✗
Digital Inputs	✓	✓
Digital Outputs	✓	✓
Relay Outputs	✗	✗
Motor Thermistor	✗	✗
STO	✗	✗
PWM Outputs	✗	✗
Power Stack Feedbacks	✗	✗
Encoder Feedback Option Card	✗	✗
GPIO Option Card	✗	✗
Anybus Comms Options	✓	✓

## 10 Routine Maintenance & Repair

### 10.1 Routine Maintenance

Periodic inspection of the inverter should check:

1. For build up of dust obstructions that may obstruct the ventilation of the product. This should be removed using dry air.
2. Tightness of power connections are at the recommended terminal tightening torque as specified in this manual.

### 10.2 Preventative Maintenance

#### 10.2.1 Main Duct Cooling Fans

The Main Duct Cooling fans are designed to be field replaceable by a competent person.

For preventative maintenance, replace the fan cassettes every 5 years of operation, or whenever the inverter trips on “10 Heatsink Temp” during normal operation.

#### 10.2.2 DC Link Capacitors

For preventative maintenance, the DC link capacitors should be replaced every 10 years of operation, or when the inverter trips on “20 VDC Ripple” under normal operating conditions.

The unit must be returned to your local Parker Repair Centre for replacement.

### 10.3 Repair

In the event of a drive failure, the inverter should be returned to a local Parker Repair Centre. No attempt should be made by the user to repair the unit themselves. Only Parker trained personnel are permitted to repair this product in order to maintain certifications, reliability, and quality levels.

When returning a faulty product, the user should:

1. Where possible, save the application data onto either a  $\mu$ SD card using the ‘Clone’ feature, or onto a PC by performing a configuration ‘Extraction’ using the DSE configuration tool.
2. Contact the local Repair Centre, who will arrange the return of the unit and assign an Authorisation To Return (ATR) number. This is used as a reference on all paperwork returned with the faulty item.

Customers should be ready with the following information:

- Product model and serial number (found on the product rating label)
  - Detailed information on the nature of the fault (Trip messages, user application and history).
3. Pack and dispatch the unit using original packaging materials where retained, or in suitable packaging materials that ensure that no additional damage is caused to the unit during transit. Please ensure that if used, packing chips do not enter the unit.

# 11 Compliance

## 11.1 Applicable Standards

Standard No.	Title / Description
EN 61800-3:2018	Adjustable speed electrical power drive systems <i>Part 3: EMC requirements and specific test methods.</i>
EN 61800-5-1:2007+A11:2021	Adjustable speed electrical power drive systems <i>Part 5-1: Safety requirements – Electrical, thermal and energy.</i>
EN 61800-5-2:2017	Adjustable speed electrical power drive systems <i>Part 5-2: Safety requirements – Functional.</i>
EN ISO 13849-1:2015	Safety of machinery – Safety-related parts of control systems <i>Part 1: General principles for design</i>
EN 60204-1:2018	Safety of machinery – Electrical equipment of machines <i>Part 1: General requirements.</i>
EN 61000-3-2:2019+A1:2021	Electromagnetic Compatibility (EMC) <i>Part 3-2: Limits – Limits for harmonic current emissions (equipment input current up to and including 16A per phase).</i>
EN62061:2005 Annex E+A2:2015	Safety of machinery <i>Functional safety of safety related electrical, electronic and programmable electronic control systems.</i>
IEC 61000-3-12:2011+AMD1:2021	Electromagnetic compatibility (EMC) <i>Part 3-12: Limits – Limits for harmonic currents produced by equipment connected to public low-voltage systems with input currents &gt;16A and '575A per phase.</i>
BS EN IEC 61000-6-2:2019	Electromagnetic compatibility (EMC) <i>Part 6-2: General standards – Immunity for industrial environments.</i>
BS EN IEC 61000-6-3:2021	Electromagnetic compatibility (EMC) <i>Part 6-3: General standards - Emission standard for residential, commercial and light-industrial environments.</i>
BS EN IEC 61000-6-4:2019	Electromagnetic compatibility (EMC) <i>Part 6-4: General standards – Emission standard for residential, commercial and light-industrial environments.</i>
UL61800-5-1	Adjustable speed electrical power drive systems <i>Part 5-1: Safety requirements – Electrical, thermal and energy. Edition 1</i>
CSA 22.2 No.274	Adjustable speed drives <i>2<sup>nd</sup> Edition April 2017</i>
NFPA	National Electrical Code, National Fire Protection Agency <i>Part 70</i>

## 11.2 European Compliance

### 11.2.1 CE Marking

The CE marking is placed upon the product by Parker Hannifin Manufacturing to facilitate its free movement within the European Economic Area (EEA). The CE marking provides a presumption of conformity to all applicable directives. Harmonized standards are used to demonstrate compliance with the essential requirements laid down in those relevant directives.

It must be remembered that there is no guarantee that combinations of compliant components will result in a compliant system. This means that compliance to harmonised standards will have to be demonstrated for the system as a whole to ensure compliance with the directive.



**WARNING!**

Local wiring regulations always take precedence.  
Where there are any conflicts between regulatory standards - for example, earthing requirements for electromagnetic compatibility, safety shall always take precedence.

**Low Voltage Directive**

When installed in accordance with this manual, the product will comply with the low voltage directive 2014/35/EU.

**PROTECTIVE EARTH (PE) CONNECTIONS**

Only one protective earth  conductor is permitted at each protective earth terminal contacting point.



Unless local wiring guidelines state otherwise, the minimum PE earth conductor should be as follows:

Cross-sectional area of phase conductors 'S' (mm <sup>2</sup> )	Minimum cross-sectional area of PE conductor 'S <sub>P</sub> ' (mm <sup>2</sup> )
$S \leq 16$	S
$16 < S \leq 35$	16
$35 < S$	$S / 2$

**Note:** Values in table assume PE conductor is the same material as the phase conductors

If the PE earth conductor size according to the table above is <math>10\text{mm}^2</math> (8 AWG) copper Cu conductor, a second protective earth connection using a conductor of the same cross-sectional area as the original must be added. This is due to the current flowing in the Y-Caps being >3.5mA.

**EMC Directive**

When installed in accordance with this manual the product will comply with the electromagnetic compatibility directive 2014/30/EU.

The following information is provided to maximise the Electro Magnetic Compatibility (EMC) of VSDs and systems in their intended operating environment, by minimising their emissions and maximising their immunity.

**Machinery Directive**

When installed in accordance with this manual the product will comply with the machinery directive 2006/42/EC.

**WARNING!**

This product is classified under category 21 of annex IV as 'logic units to ensure safety functions'.  
All instructions, warnings and safety information can be found in 'Chapter 8: Safe Torque Off (STO): SIL2/PLd'.



This product is a component to be incorporated into machinery and may not be operated alone. The complete machinery or installation using this equipment may only be put into service when all safety considerations of the Directive are fully implemented. Particular reference should be made to EN60204-1 (Safety of Machinery - Electrical Equipment of Machines).



## 11.2.2 EMC Compliance

A list of EMC Compliance definitions relevant to this section are listed in the table below:

Terminology	Description
<b>Environment</b>	
First Environment:	Environment that includes domestic premises, it also includes establishments directly connected without transformers to a low-voltage power supply network which supplies buildings used for domestic purposes. Note: Houses, apartments, commercial premises or offices in a residential building are examples of first environment locations.
Second Environment:	Environment that includes all establishments other than those directly connected to a low-voltage power supply network which supplies buildings used for domestic purposes. Note: Industrial areas, technical areas of any building fed from a dedicated transformer are examples of second environment locations.
<b>Category</b>	
Category C1:	PDS (Power Drive System) of rated voltage less than 1000V, intended for use in the first environment.
Category C2:	PDS (Power Drive System) of rated voltage less than 1000V, which is neither a plug-in device nor a movable device and, when used in the first environment, is intended to be installed and commissioned only by a professional. Note: A professional is a person or an organisation having necessary skills in installing and/or commissioning power drive systems, including their EMC aspects.
Category C3:	PDS (Power Drive System) of rated voltage less than 1000V, intended for use in the second environment and not intended for use in the first environment.
Category C4:	PDS (Power Drive System) of rated voltage equal to or above 1000V, or rated current equal to or above 400A, or intended for use in complex systems in the second environment.

## 11.2.3 EMC Standards

The EMC standards are concerned with two types of emission:

- Radiated:**  
Those in the band 30MHz – 1000MHz which radiate into the environment.
- Conducted:**  
Those in the band 150kHz – 30MHz which are injected into the supply.

### Radiated Emissions: Standards

The Radiated Emissions standards have common roots (CISPR 11 & CISPR14), so there is some commonality in the test levels applied in different environments as shown in the table below:

Standards			Limits*	
Product Specific	Generic		Frequency (MHz)	dB(μV/m)
EN 61800-3	EN61000-6-3	EN61000-6-4		
Category C1	Equivalent	Not applicable	30 - 230	30
			230 - 1000	37
Category C2	Not applicable	Equivalent	30 - 230	40
			230 - 1000	47

Standards			Limits*	
Product Specific	Generic		Frequency (MHz)	dB(μV/m)
EN 61800-3	EN61000-6-3	EN61000-6-4		
Category C3	These limits have no relationships with the generic standards.		30 - 230	50
			230 - 1000	60
<p><b>* = Limit has been adjusted for a measurement distance of 10m.</b></p> <p>For category C1, if the field strength measurement at 10m cannot be made because of high ambient noise levels or for other reasons, the measurement may be made at 3m.</p> <p>If the 3m distance is used, the measurement result obtained shall be normalised to 10m by subtracting 10dB from the result.</p> <p>In this case, care should be taken to avoid near field effects, particularly when the PDS (Power Drive System) is not of an appropriately small size, and at frequencies near 30MHz.</p> <p>When multiple drives are used, 3dB attenuation per drive needs to be added.</p>				

### Conducted Emissions: Standards

The Conducted Emissions standards have common roots (CISPR 11 & CISPR14), so there is some commonality in the test levels applied in different standards and environments as shown in the table below:

Standards			Limits*		
Product Specific	Generic		Frequency (MHz)	Quasi Peak (dB/μV)	Average (dB/μV)
EN 61800-3	EN61000-6-3	EN61000-6-4			
Category C1	Equivalent	Not applicable	0.15 - 0.5	66 > 56 <sup>†</sup>	56 > 46 <sup>†</sup>
			0.5 - 5.0	56	46
			5.0 - 30.0	60	50
Category C2	Not applicable	Equivalent	0.15 - 0.5	79	66
			0.5 - 5.0	73	60
			5.0 - 30.0	73	60
Category C3 (I ≤ 100A)	These limits have no relationships with the generic standards.		0.15 - 0.5	100	90
			0.5 - 5.0	86	76
			5.0 - 30.0	90 > 70 <sup>†</sup>	80 > 60 <sup>†</sup>
Category C3 (I ≥ 100A)	These limits have no relationships with the generic standards.		0.15 - 0.5	130	120
			0.5 - 5.0	125	115
			5.0 - 30.0	115	105

<sup>†</sup> = Limit decreases with the Log of frequency for the specified frequency range

## Radiated & Conducted Emissions: Compliance Overview

<div style="display: inline-block; text-align: center;"> <p><b>WARNING!</b></p> <p>In a domestic environment, this product may cause radio interference, in which case supplementary mitigation measures may be required.</p> </div>
--

EN 61800-3	Category C1	Category C2	Category C3
<b>Radiated Emissions</b>			
Frame 2	n / a	n / a	When mounted inside a cubicle with the required attenuation between: 30 – 45MHz @ 8dB
Frame 3			
Frame 4			
Frame 5			
Frame 6			
Frame 7			
Frame 8			
Frame 9			
Frame 10			
<b>Conducted Emissions</b>			
Frame 2	<b>External EMC Filter</b> required. See emissions plots below.	<b>External EMC Filter</b> required. See emissions plots below.	<b>Internal EMC Filter</b> Maximum motor cable length 25m
Frame 3			
Frame 4			
Frame 5			
Frame 6			
Frame 7			
Frame 8			
Frame 9			
Frame 10			

Conducted emission solutions true for default switching frequency of inverter. Operation at higher switching frequencies will require extra filtering.

<div style="display: inline-block; text-align: center;"> <p><b>WARNING!</b></p> <p>The drive is suitable for use on TN supplies when fitted with the internal filter. When used on an IT supply, all Y-cap connections to earth need to be removed, hence the filter effectiveness is reduced.</p> <p>Refer to 'Chapter 6: Installation' for details on how to remove the Y-cap and VDR disconnects when installing the product on an IT supply.</p> </div>
---

### Conducted Emissions Plots

Where a solution is required that is not met by the AC20 product range offering, filtered emissions plots have been provided to allow specialist EMC filter design companies to tailor a design to meet the customer's needs.

Notes on Conducted Emissions Plots:

- Plot is of 'worst' line phase of largest power rating, of a given frame size.
- All tests carried out with an unloaded motor.
- Shielded motor cable, 25m in length was used.
- All filter capacitors were connected in circuit (i.e., Y-Caps) for each test.

**1ø, 230V Products:**

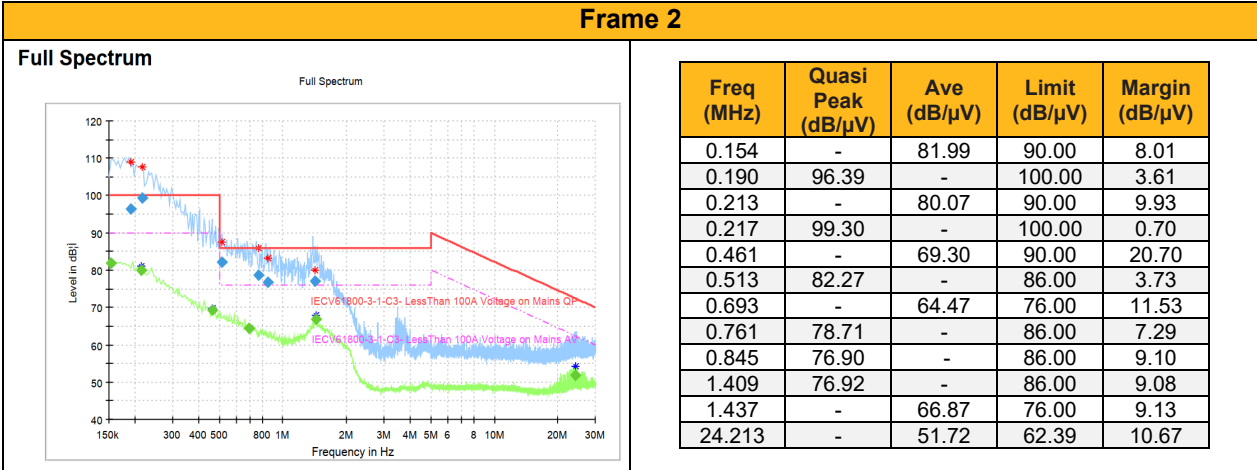

**3ø, 230V Products:**

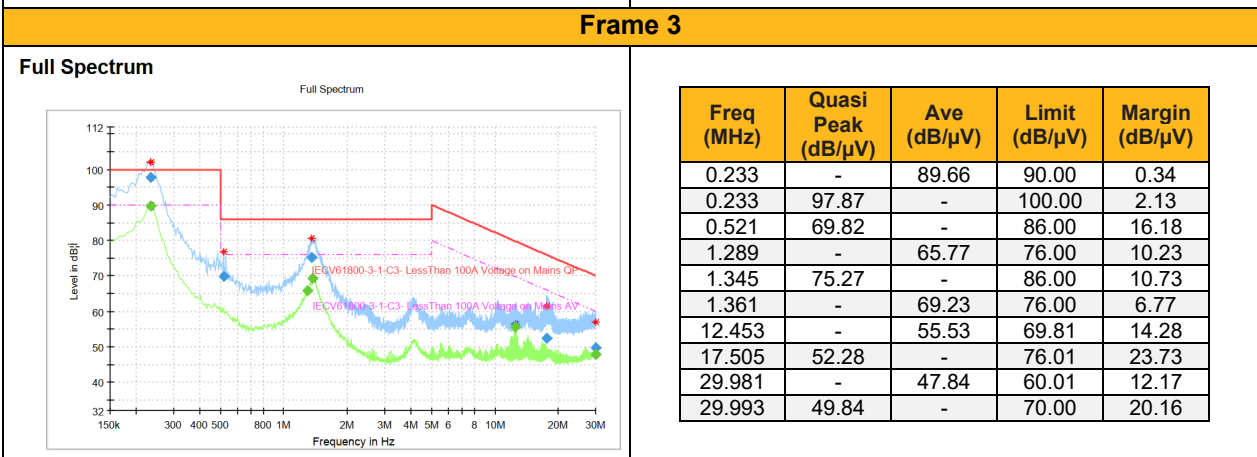
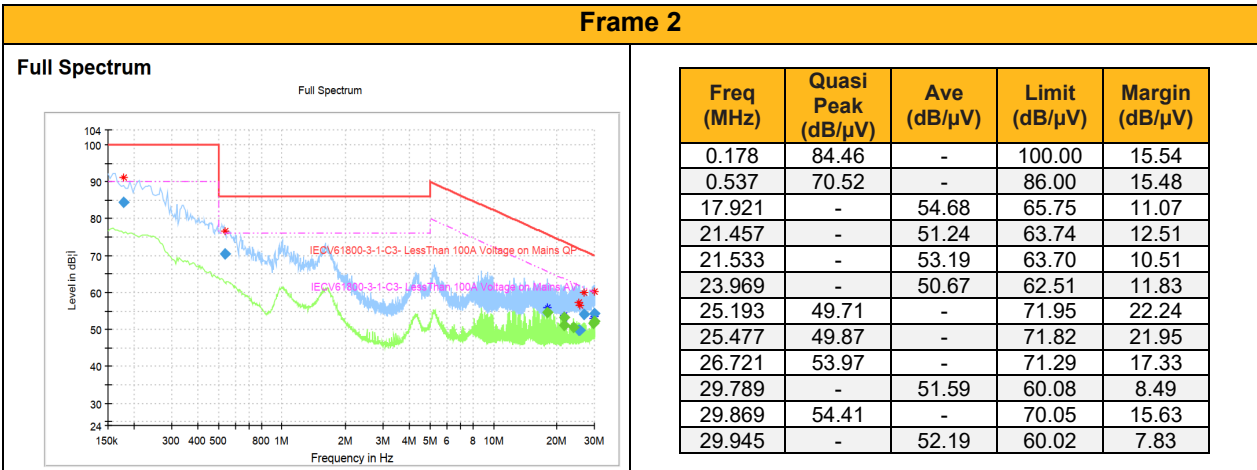

**Frame 4**

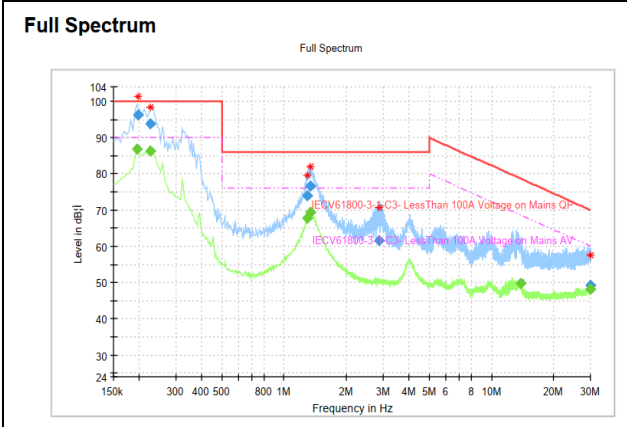

Freq (MHz)	Quasi Peak (dB/μV)	Ave (dB/μV)	Limit (dB/μV)	Margin (dB/μV)
0.194	-	86.74	90.00	3.26
0.198	96.33	-	100.00	3.67
0.225	-	86.27	90.00	3.73
0.225	93.91	-	100.00	6.09
1.285	73.82	-	86.00	12.18
1.291	-	67.87	76.00	8.13
1.337	76.53	-	86.00	9.47
1.337	-	69.44	76.00	6.56
2.873	61.48	-	86.00	24.52
13.785	-	49.81	68.68	18.87
29.909	49.18	-	70.03	20.86
29.937	-	48.06	60.02	11.97

**Frame 5**

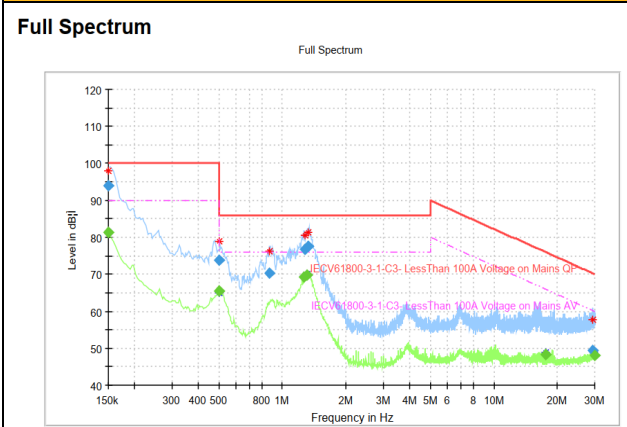

Freq (MHz)	Quasi Peak (dB/μV)	Ave (dB/μV)	Limit (dB/μV)	Margin (dB/μV)
0.150	-	81.21	90.00	8.79
0.150	93.84	-	100.00	6.16
0.501	-	65.53	76.00	10.47
0.501	73.81	-	86.00	12.19
0.869	70.24	-	86.00	15.76
1.269	-	69.33	76.00	6.67
1.277	76.71	-	86.00	9.29
1.301	-	69.81	76.00	6.19
1.329	77.47	-	86.00	8.53
17.649	-	48.42	65.92	17.51
29.261	49.42	-	70.28	20.86
29.905	-	47.98	60.04	12.05

**3ø, 400V Products:**

**Frame 2**

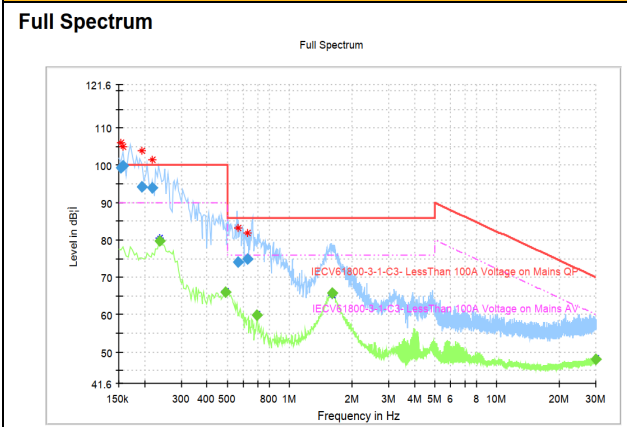

Freq (MHz)	Quasi Peak (dB/μV)	Ave (dB/μV)	Limit (dB/μV)	Margin (dB)
0.154	99.43	-	100.00	0.57
0.158	99.93	-	100.00	0.07
0.193	94.19	-	100.00	5.81
0.217	93.88	-	100.00	6.12
0.237	-	79.65	90.00	10.35
0.489	-	65.92	90.00	24.08
0.565	74.08	-	86.00	11.92
0.629	74.77	-	86.00	11.23
0.697	-	59.74	76.00	16.26
1.597	-	65.80	76.00	10.20
29.937	-	48.08	60.02	11.95

**Frame 3**

**Full Spectrum**

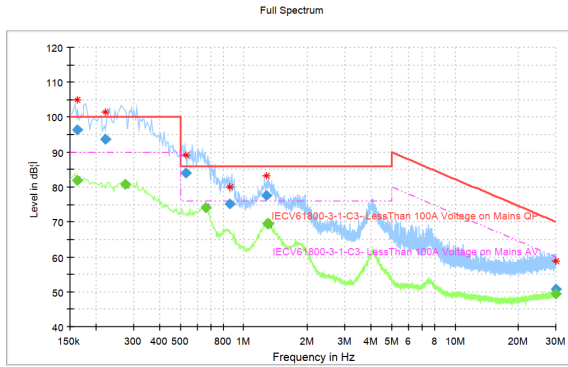

Freq (MHz)	Quasi Peak (dB/μV)	Ave (dB/μV)	Limit (dB/μV)	Margin (dB/μV)
0.162	-	81.79	90.00	8.21
0.162	96.38	-	100.00	3.62
0.221	93.81	-	100.00	6.19
0.273	-	80.84	90.00	9.16
0.529	84.01	-	86.00	1.99
0.661	-	74.11	76.00	1.89
0.857	75.16	-	86.00	10.84
1.273	77.47	-	86.00	8.53
1.289	-	69.42	76.00	6.58
1.305	-	69.60	76.00	6.40
29.913	50.72	-	70.03	19.32
29.959	-	49.51	60.02	10.51

**Frame 4**

**Full Spectrum**

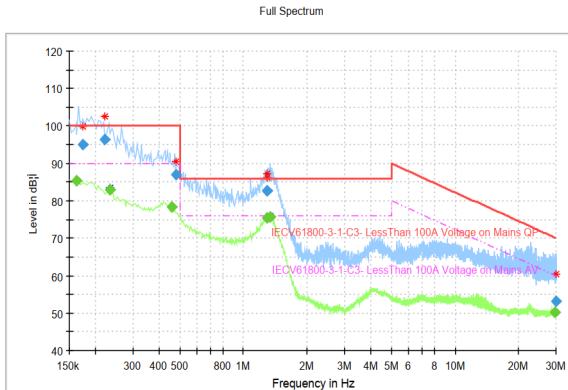

Freq (MHz)	Quasi Peak (dB/μV)	Ave (dB/μV)	Limit (dB/μV)	Margin (dB/μV)
0.162	-	85.27	90.00	4.73
0.174	95.10	-	100.00	4.90
0.221	96.35	-	100.00	3.65
0.233	-	83.01	90.00	6.99
0.457	-	78.27	90.00	11.73
0.481	87.10	-	100.00	12.90
1.287	-	75.40	76.00	0.60
1.289	82.78	-	86.00	3.22
1.293	82.60	-	86.00	3.40
1.333	-	75.83	76.00	0.17
29.805	-	50.14	60.07	9.94
29.873	53.26	-	70.05	16.79

**Frame 5**

**Full Spectrum**

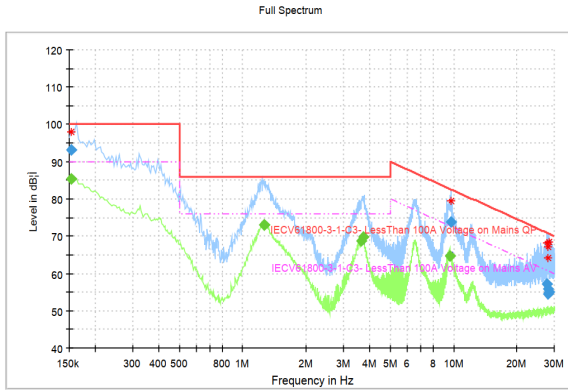

Freq (MHz)	Quasi Peak (dB/μV)	Ave (dB/μV)	Limit (dB/μV)	Margin (dB/μV)
0.154	---	85.39	90.00	4.61
0.154	93.16	---	100.00	6.84
1.261	---	73.13	76.00	2.87
1.265	---	73.06	76.00	2.94
3.631	---	68.6	76.00	7.40
3.725	---	69.77	76.00	6.23
9.625	---	64.8	72.69	7.89
9.669	73.94	---	82.64	8.70
27.649	57.2	---	70.91	13.71
27.921	55.74	---	70.80	15.06
28.069	54.51	---	70.74	16.24
28.357	55.05	---	70.63	15.58

**Frame 6**

**Full Spectrum**

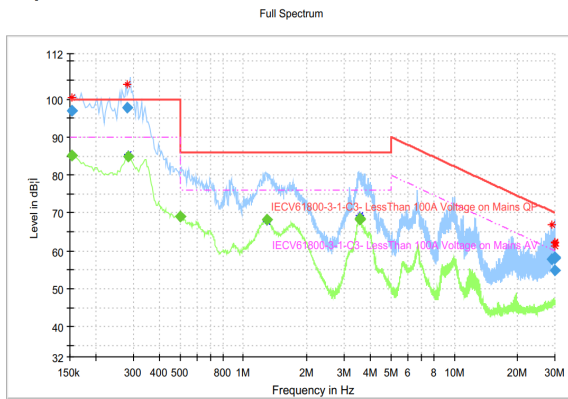

Freq (MHz)	Quasi Peak (dB/μV)	Ave (dB/μV)	Limit (dB/μV)	Margin (dB/μV)
0.154	-	85.07	90.00	4.93
0.154	97.03	-	100.00	2.97
0.281	97.87	-	100.00	2.13
0.285	-	84.98	90.00	5.02
0.501	-	69.11	76.00	6.89
1.293	-	68.23	76.00	7.77
3.549	-	68.36	76.00	7.64
3.569	-	68.53	76.00	7.47
29.065	57.72	-	70.35	12.63
29.941	58.08	-	70.02	11.94
29.977	54.93	-	70.01	15.08
29.981	58.41	-	70.01	11.60



**Frame 7**

**Full Spectrum**

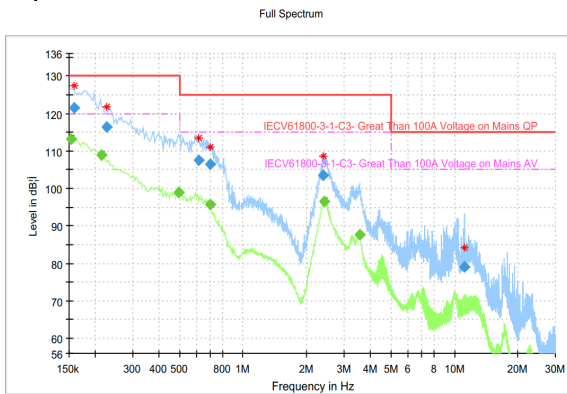

Freq (MHz)	Quasi Peak (dB/μV)	Ave (dB/μV)	Limit (dB/μV)	Margin (dB/μV)
0.154	-	113.17	120.00	6.83
0.158	121.63	-	130.00	8.37
0.213	-	108.90	120.00	11.10
0.225	116.29	-	130.00	13.71
0.497	-	98.99	120.00	21.01
0.617	107.54	-	125.00	17.46
0.697	106.34	-	125.00	18.66
0.701	-	95.74	115.00	19.26
2.401	103.49	-	125.00	21.51
2.405	-	96.54	115.00	18.46
3.561	-	87.58	115.00	27.42
11.101	78.99	-	115.00	36.01

**Frame 8**

**Full Spectrum**

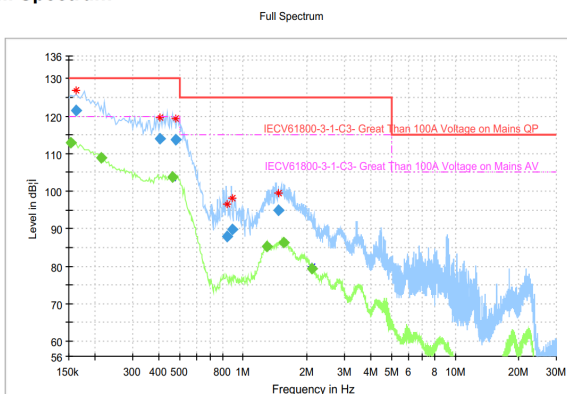

Freq (MHz)	Quasi Peak (dB/μV)	Ave (dB/μV)	Limit (dB/μV)	Margin (dB/μV)
0.154	-	112.95	120.00	7.05
0.162	121.57	-	130.00	8.43
0.213	-	108.84	120.00	11.16
0.405	113.95	-	130.00	16.05
0.465	-	103.75	120.00	16.25
0.477	113.71	-	130.00	16.29
0.841	87.99	-	125.00	37.01
0.889	89.94	-	125.00	35.06
1.285	-	85.22	115.00	29.78
1.467	94.95	-	125.00	30.05
1.545	-	86.40	115.00	28.60
2.105	-	79.48	115.00	35.52

**Frame 9**

**Full Spectrum**

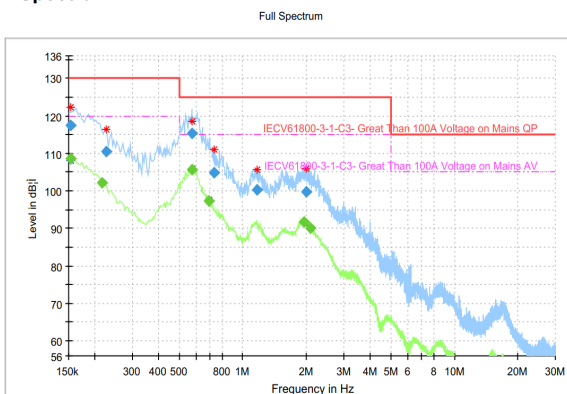

Freq (MHz)	Quasi Peak (dB/μV)	Ave (dB/μV)	Limit (dB/μV)	Margin (dB/μV)
0.154	-	108.57	120.00	11.43
0.154	117.38	-	130.00	12.62
0.217	-	102.21	120.00	17.79
0.225	110.48	-	130.00	19.52
0.573	115.35	-	125.00	9.65
0.577	-	105.57	115.00	9.43
0.693	-	97.45	115.00	17.55
0.733	104.76	-	125.00	20.24
1.161	100.20	-	125.00	24.80
1.941	-	91.69	115.00	23.31
2.001	99.87	-	125.00	25.13
2.081	-	90.06	115.00	24.94

**Frame 10**

**Full Spectrum**

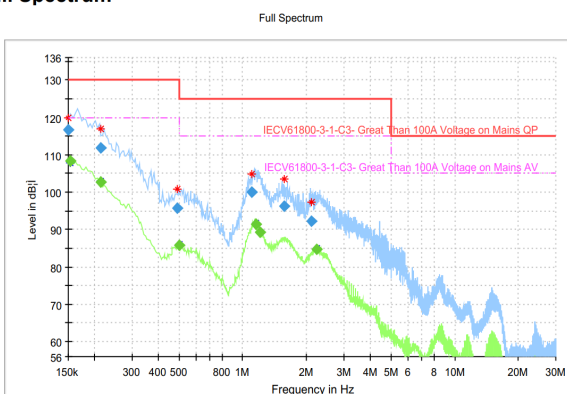

Freq (MHz)	Quasi Peak (dB/μV)	Ave (dB/μV)	Limit (dB/μV)	Margin (dB/μV)
0.150	116.55	---	130.00	13.45
0.154	---	108.33	120.00	11.67
0.213	---	102.76	120.00	17.24
0.213	111.96	---	130.00	18.04
0.493	95.69	---	130.00	34.31
0.501	---	85.77	115.00	29.23
1.105	100.02	---	125.00	24.98
1.149	---	91.35	115.00	23.65
1.213	---	89.18	115.00	25.82
1.569	96.17	---	125.00	28.83
2.113	92.35	---	125.00	32.65
2.221	---	84.84	115.00	30.16



## 11.2.4 EMC Installation Guidance

### Protective Earth (PE) Connections

**WARNING!**

Local wiring regulations take precedence and may require the protective earth connection of the motor to be connected locally, i.e., not as specified in these instructions. This will not cause shielding problems because of the relatively high RF impedance of the local earth connection.

When installing an AC20 in control cubicle, Parker recommends using a star-point earthing method where 'noisy' and 'clean' earths are separated out. Four separate earth bus bars, three of which are insulated from the mounting panel, connect to a single earth point (star point) near the incoming safety earth from the main supply:

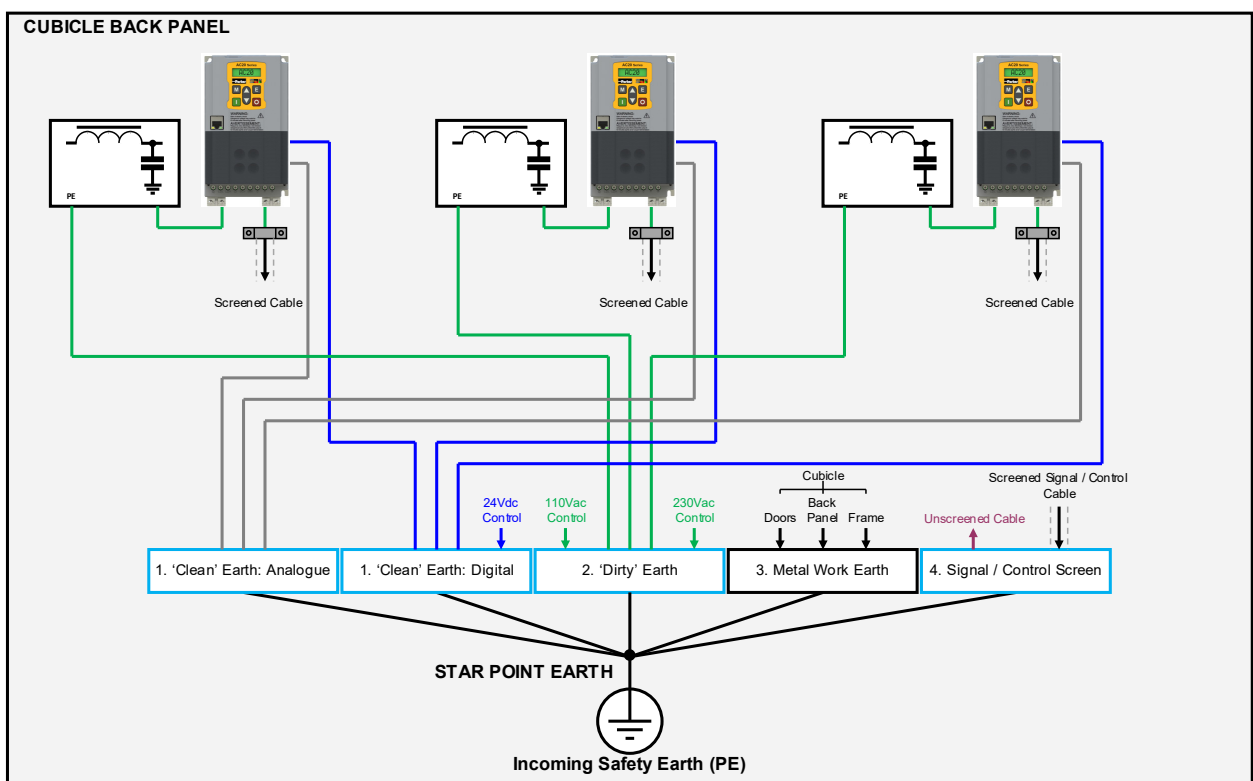

**Key:**

- 'CLEAN' Analogue Earth Cables
- 'CLEAN' Digital Earth Cables
- 'DIRTY' Earth Cables
- Enclosure Earth Cables
- Unscreened Signal Cables
- Screened Multi-Core Cables
- U-Clip Connected to Back Panel
- Busbar Insulated from Back Panel
- Busbar Connected to Back Panel

**1. Clean Earth Busbar (insulated from the mounting panel):**

- Used as a reference point for all signal and control cabling.
- It may be further subdivided into an analog and a digital reference busbar, each separately connected to the star earthing point.
- The digital reference is also used for any 24V control.
- Control / Signal, Encoder, Analogue Input and Communication cables require screening, with the screen connected at the inverter end **only**.

However, if high frequency noise is a problem, earth the screen at the non-inverter end via a 0.1 $\mu$ F capacitor, and move the screen connect at the inverter end from the control board terminals to the protective earth point.  $\oplus$

**2. Dirty Earth Busbar (insulated from the mounting panel):**

- Used for all power earths, i.e., protective earth connections.
- It is also used as a reference for any 110 or 220V control used, and for the control transformer screen.

**3. Metal Work Earth Busbar:**

- The control cubicle mounting panel is used as this earth busbar and should provide earthing points for all parts of the cubicle including panels and doors.
- This busbar is also used for power screened cables that terminate near to ( $\approx$ 10cm), or directly into an inverter, such as Motor cables, Dynamic Brake Resistor cables (and resistors themselves), or connections between inverters.
- Use U-clips to clamp the screened cables to the back panel to ensure optimum HF connection.

**4. Signal / Control Screen Earth Busbar (insulated from the mounting panel):**

- Used for signal/control screened cables which do not go directly to the inverter.
- Place this busbar as close as possible to the point of cable entry.
- 'U' clamp the screened cables to the busbar to ensure an optimum HF connection.

Flexible, large cross-section cable or braids should be used to ensure low HF impedance.

Bus bars should be arranged so that the connections to the single earth point is as short as possible.

### Cabling Requirements

Cables used for connecting to inverters, can be termed as electrically 'Clean', 'Noisy' or 'Sensitive'. The diagram below shows an overview:

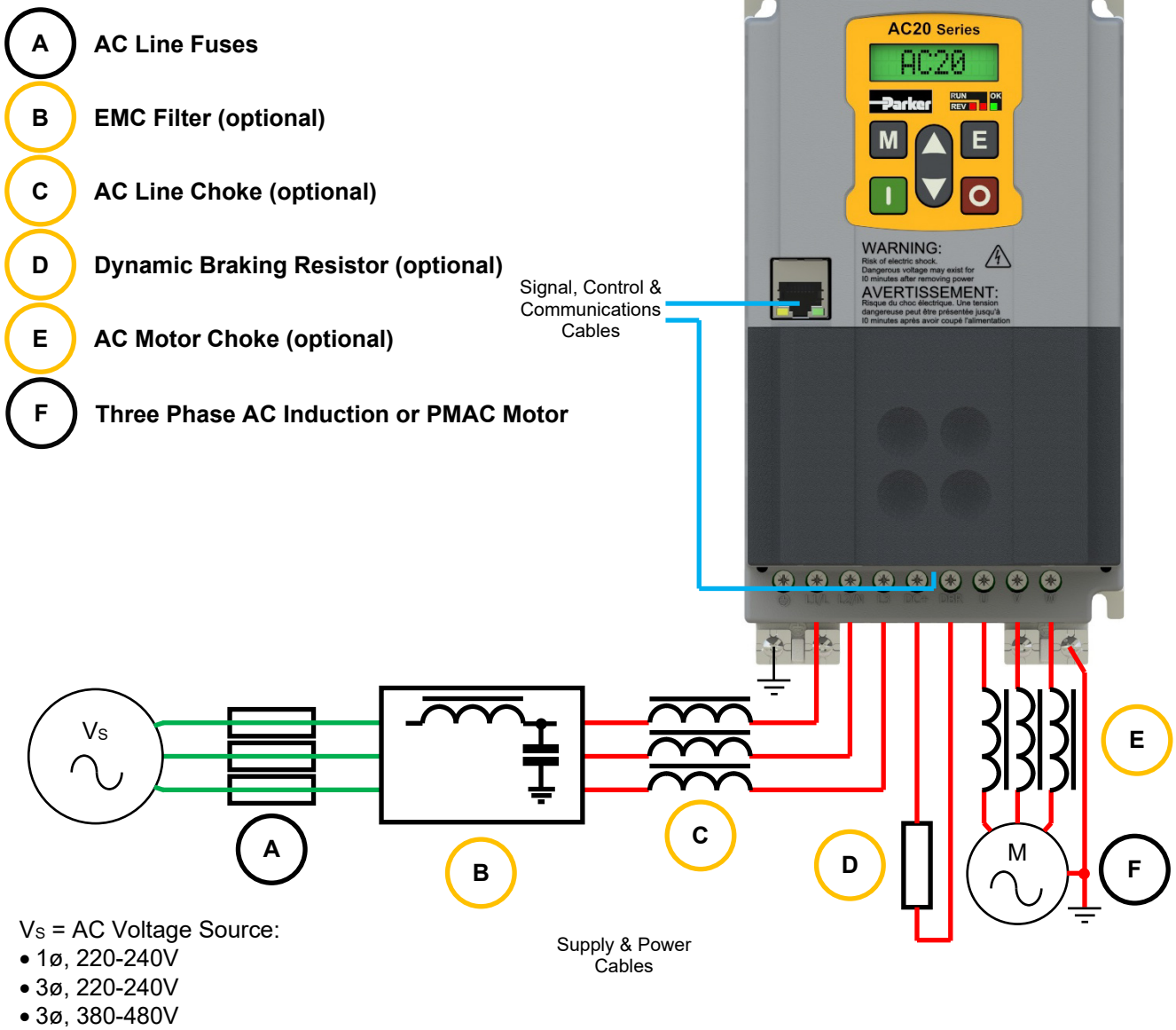

Cable routing should be planned in a way that segregates certain cable types to meet EMC compliance:

- Use the shortest possible motor cable lengths.
- When connecting multiple motors to a single inverter, use a star junction point for motor cable connections. Use a metal box with entry and exit cable glands to maintain shield integrity.
- Keep electrically 'noisy' and 'sensitive' cables apart.
- Keep electrically 'noisy' and 'sensitive' parallel cable runs to a minimum. Separate parallel cable runs by at least 0.25 meters. For runs longer than 10 meters, separation should be increased proportionally. For example, if the parallel runs were 50m, then the separation would be  $(50/10) \times 0.25\text{m} = 1.25\text{m}$ .
- 'Sensitive' cables should cross 'noisy' cables at 90°.
- Never run 'sensitive' cables close or parallel to either the Motor, DC Link or Dynamic Brake circuits for any distance.
- Never run AC Line Supply, DC Link or Motor cables in the same bundle as either the Signal / Control or Feedback cables, even if they are screened.
- Ensure the optional External EMC Filter input and output cables are separately routed and do not couple across the filter.

<b>AC Line Supply Cable</b>	
Cable Type:	Unscreened
Segregation:	From all other wiring (clean)
Length Limit:	Unlimited
<b>External EMC Filter to Inverter Input Cable</b>	
Cable Type:	Screened / Armoured
Segregation:	From all other wiring (noisy)
Length Limit:	0.3m
Screen to Earth:	Both ends
<b>Motor Cable</b>	
Cable Type:	Screened / Armoured
Segregation:	From all other wiring (noisy)
Length Limit:	50m (up to 300m with an output choke)
Screen to Earth:	Both ends
<b>Brake Cable</b>	
Cable Type:	Screened / Armoured
Segregation:	From all other wiring (noisy)
Length Limit:	25m
Screen to Earth:	Both ends
<b>Signal / Control Cables</b>	
Cable Type:	Screened
Segregation:	From all other wiring (sensitive)
Length Limit:	25m
Screen to Earth:	Inverter end only

## Mitigating Radiated Emissions

To mitigate against the effects of radiated emissions, the following considerations should be made when installing the Inverter within a Variable Speed Drive (VSD) system:

### 1. Equipment Placement

Magnetic / Electric Field sensitive equipment should not be placed within 0.25 meters of the following components in the VSD system:

- Variable Speed Drive (VSD)
- EMC Output Filters
- Input or Output Chokes / Transformers
- The cable between VSD and motor (even when screened/armoured)
- Connections to external braking chopper and resistor (even when screened/armoured)
- AC/DC brushed motors (due to commutation)
- DC link connections (even when screened/armoured)
- Relays and contactors (even when suppressed)

## 2. Additive Emissions

Emissions from individual components tend to be additive. To reduce the emissions:

- The equipment must be mounted in a metal cubicle. Refer to 'Radiated & Conducted Emissions: Compliance Overview' section above.
- The cubicle should be as free of openings as is practical. Vent systems suitable for EMC applications are available from cubicle vendors and should be used.

## 3. Radiated Magnetic & Electric Fields

Radiated magnetic and electric fields inside the cubicle will be high and any components fitted inside must be sufficiently immune:

- All cable entry and exits (power, control, and communication) should use screened cable
- Earth screen at both ends connecting to the motor frame and cubicle.
- Use of screened/armored cable between VSD/cubicle and motor containing the motor protective earth (PE) connection is most important. If shielded cable is not available, lay unshielded motor cables in a metal conduit which will act as a shield. The conduit must be continuous with a direct electrical contact to the VSD and motor housing. If links are necessary, use braid with a minimum cross-sectional area of 10mm<sup>2</sup> (8 AWG).
- Use 360° screen terminations:

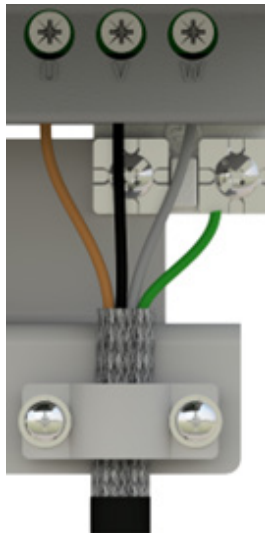

## 4. Installations in Hazardous Areas

Some installations in hazardous areas may preclude direct earthing at both ends of the screen. In this case earth one end of the screen cable via a 1μF 50Vac capacitor, and the other as normal:

- Keep unshielded cable as short as possible inside the cubicle.
- Always maintain the integrity of the shield. If the cable is interrupted to insert contactors etc., re-connect the screen using the shortest possible route. Some motor gland boxes and conduit glands are made of plastic. If this is the case, then braid must be connected between the screen and the chassis. In addition, at the motor end, ensure that the screen is electrically connected to the motor frame since some terminal boxes are insulated from the frame by gasket/paint.
- Keep the length of screen stripped-back as short as possible when making screen connections.

### **Issues arising from long Motor Cable runs**

Because cable capacitance and hence conducted emissions increase with motor cable length, conformance to EMC limits is only guaranteed up to a maximum cable length as specified in the table in the 'Cabling Requirement' section above.

Screened/armoured cable has significant capacitance between the conductors and screen, which increases linearly with cable length - typically 200pF/m, though this varies with cable type and current rating.

Long cable lengths may have the following undesirable effects:

- Inverter 'overcurrent' trip events as the cable capacitance is charged and discharged at the switching frequency.
- Increased conducted emissions that degrade the performance of the internal EMC filter due to common mode choke saturation.
- Increased heating inside the internal EMC filter (as a consequence of a saturated common mode choke).
- RCD (Residual Current Devices) trips, due to increased high frequency earth current.

These effects can be overcome by adding the following:

- External EMC Filter (Input or Output), located as close as possible to the inverter
- AC Line Chokes
- AC Motor Chokes

Refer to 'Chapter 7: Associated Equipment' for recommended Associated Equipment.

For RCD trips, internal Y-Capacitor and Overvoltage Suppressors to earth connections can be removed by means of a link disconnect. Refer to 'Chapter 6: Installation' for details on how to disconnect them from earth.

## 11.2.5 Harmonic Information

### 1 $\emptyset$ , 230V Products

**Drive Type: 3 $\emptyset$ , Fundamental Voltage = 230V**

Line Inductance = 84 $\mu$ H, PSCC = 5kA

The 1.5kW is designated as "Professional Equipment" as defined in EN61000-3-2.

<b>Frame Size:</b>	<b>2</b>	
<b>Product Code:</b>	20G-12-0070...	20G-12-0100...
<b>Power Rating (kW):</b>	1.5	2.2
<b>Current Rating (A):</b>	7	10
<b>Harmonic No.</b>	<b>RMS Current (A)</b>	
1	10.37	15.48
3	5.98	7.32
5	1.18	0.41
7	0.91	1.19
9	0.38	0.32
11	0.35	0.38
13	0.18	0.26
15	0.18	0.11
17	0.10	0.19
19	0.11	0.02
21	0.06	0.11
23	0.07	0.05
25	0.04	0.05
27	0.05	0.06
29	0.02	0.01
31	0.04	0.05
33	0.02	0.01
35	0.03	0.03
37	0.01	0.02
39	0.02	0.01
40	0.00	0.00
<b>Total RMS Current (A):</b>	<b>12.08</b>	<b>17.18</b>
<b>THD: Current (%):</b>	<b>59.77</b>	<b>48.16</b>



**3 $\phi$ , 230V Products****Drive Type: 3 $\phi$ , Fundamental Voltage = 230V**Line Inductance = 84 $\mu$ H, PSCC = 5kA

The Frame 2's are designated as "Professional Equipment" as defined in EN61000-3-2.

<b>Frame Size:</b>	<b>2</b>		<b>3</b>
<b>Product Code:</b>	20G-32-0070...	20G-32-0100...	20G-33-0170...
<b>Power Rating (kW):</b>	1.5	2.2	4
<b>Current Rating (A):</b>	7	10	17
<b>Harmonic No.</b>	<b>RMS Current (A)</b>		
1	6.01	9.21	16.09
3	0.01	0.01	0.01
5	3.25	4.07	5.40
7	1.49	1.22	0.35
9	0.00	0.01	0.01
11	0.48	0.80	1.33
13	0.47	0.33	0.20
15	0.00	0.00	0.01
17	0.13	0.34	0.62
19	0.21	0.13	0.22
21	0.00	0.00	0.01
23	0.04	0.19	0.35
25	0.11	0.06	0.19
27	0.00	0.00	0.01
29	0.01	0.12	0.21
31	0.06	0.03	0.16
33	0.00	0.00	0.01
35	0.02	0.09	0.12
37	0.03	0.02	0.12
39	0.00	0.00	0.01
40	0.00	0.00	0.00
<b>Total RMS Current (A):</b>	<b>7.03</b>	<b>10.19</b>	<b>17.50</b>
<b>THD: Current (%):</b>	<b>60.71</b>	<b>47.36</b>	<b>35.01</b>

<b>Drive Type: 3<math>\phi</math>, Fundamental Voltage = 230V</b>			
<b>Line Inductance = 84<math>\mu</math>H, PSCC = 5kA</b>			
<b>Frame Size:</b>	<b>4</b>	<b>5</b>	
<b>Product Code:</b>	20G-34-0210...	20G-35-0300...	20G-35-0400...
<b>Power Rating (kW):</b>	5.5	7.5	11
<b>Current Rating (A):</b>	21	30	40
<b>Harmonic No.</b>	<b>RMS Current (A)</b>		
1	20.04	29.14	39.02
3	0.01	0.02	0.02
5	6.08	7.40	8.42
7	0.42	1.65	2.88
9	0.01	0.02	0.02
11	1.53	1.72	1.47
13	0.49	1.03	1.24
15	0.01	0.02	0.01
17	0.68	0.53	0.08
19	0.39	0.55	0.32
21	0.01	0.01	0.01
23	0.34	0.08	0.30
25	0.28	0.23	0.11
27	0.01	0.01	0.01
29	0.16	0.11	0.21
31	0.19	0.04	0.19
33	0.01	0.01	0.01
35	0.06	0.13	0.05
37	0.12	0.07	0.11
39	0.01	0.01	0.01
40	0.00	0.00	0.00
<b>Total RMS Current (A):</b>	<b>21.02</b>	<b>30.19</b>	<b>40.07</b>
<b>THD: Current (%):</b>	<b>31.80</b>	<b>27.06</b>	<b>23.38</b>

**3ø, 400V Products****Drive Type: 3ø, Fundamental Voltage = 400V**

Line Inductance = 146µH, PSCC = 5kA

These products are designated as "Professional Equipment" as defined in EN61000-3-2.

<b>Frame Size:</b>	<b>2</b>		
<b>Product Code:</b>	20G-42-0040...	20G-42-0065...	20G-42-0090...
<b>Power Rating (kW):</b>	1.5	2.2	4
<b>Current Rating (A):</b>	4	6.5	9
<b>Harmonic No.</b>	<b>RMS Current (A)</b>		
1	3.74	5.99	8.21
3	0.00	0.00	0.00
5	2.62	3.90	5.26
7	1.77	2.39	3.14
9	0.00	0.00	0.00
11	0.38	0.39	0.36
13	0.30	0.54	0.68
15	0.00	0.00	0.00
17	0.29	0.29	0.30
19	0.16	0.12	0.11
21	0.00	0.00	0.00
23	0.13	0.20	0.23
25	0.13	0.11	0.10
27	0.00	0.00	0.00
29	0.04	0.10	0.13
31	0.06	0.10	0.11
33	0.00	0.00	0.00
35	0.05	0.03	0.05
37	0.02	0.06	0.08
39	0.00	0.00	0.00
40	0.00	0.00	0.00
<b>Total RMS Current (A):</b>	<b>4.94</b>	<b>7.58</b>	<b>10.28</b>
<b>THD: Current (%):</b>	<b>86.08</b>	<b>77.59</b>	<b>75.39</b>

**Drive Type: 3 $\phi$ , Fundamental Voltage = 400V**

Line Inductance = 146 $\mu$ H, PSCC = 5kA

The Frame 3's are designated as "Professional Equipment" as defined in EN61000-3-2.

<b>Frame Size:</b>	<b>3</b>		<b>4</b>
<b>Product Code:</b>	20G-43-0120...	20G-43-0170...	20G-44-0230...
<b>Power Rating (kW):</b>	5.5	7.5	11
<b>Current Rating (A):</b>	12	17	23
<b>Harmonic No.</b>	<b>RMS Current (A)</b>		
1	10.76	14.89	20.72
3	0.00	0.00	0.00
5	6.23	7.70	9.33
7	3.22	3.30	3.00
9	0.00	0.00	0.00
11	0.76	1.28	1.80
13	0.93	1.02	0.81
15	0.00	0.00	0.00
17	0.15	0.42	0.73
19	0.34	0.46	0.31
21	0.00	0.00	0.00
23	0.11	0.17	0.39
25	0.12	0.25	0.14
27	0.00	0.00	0.00
29	0.10	0.08	0.24
31	0.03	0.15	0.07
33	0.00	0.00	0.00
35	0.09	0.04	0.17
37	0.02	0.10	0.04
39	0.00	0.00	0.00
40	0.00	0.00	0.00
<b>Total RMS Current (A):</b>	<b>12.90</b>	<b>17.17</b>	<b>23.02</b>
<b>THD: Current (%):</b>	<b>66.30</b>	<b>57.49</b>	<b>48.44</b>

<b>Drive Type: 3<math>\phi</math>, Fundamental Voltage = 400V</b>			
<b>Line Inductance = 146<math>\mu</math>H, PSCC = 5kA</b>			
<b>Frame Size:</b>	<b>4</b>	<b>5</b>	
<b>Product Code:</b>	20G-44-0320...	20G-45-0380...	20G-45-0440...
<b>Power Rating (kW):</b>	15	18.5	22
<b>Current Rating (A):</b>	32	38	44
<b>Harmonic No.</b>	<b>RMS Current (A)</b>		
1	29.15	35.14	41.08
3	0.00	0.00	0.00
5	12.44	13.81	15.11
7	3.45	2.85	2.22
9	0.00	0.00	0.00
11	2.42	2.87	3.27
13	0.77	0.41	0.05
15	0.00	0.00	0.00
17	1.00	1.24	1.42
19	0.23	0.08	0.29
21	0.00	0.00	0.00
23	0.55	0.69	0.77
25	0.08	0.16	0.32
27	0.00	0.00	0.00
29	0.35	0.43	0.45
31	0.06	0.17	0.29
33	0.00	0.00	0.00
35	0.24	0.28	0.27
37	0.07	0.16	0.24
39	0.00	0.00	0.00
40	0.00	0.00	0.00
<b>Total RMS Current (A):</b>	<b>32.00</b>	<b>38.00</b>	<b>43.98</b>
<b>THD: Current (%):</b>	<b>45.34</b>	<b>43.21</b>	<b>40.28</b>

<b>Drive Type: 3<math>\phi</math>, Fundamental Voltage = 400V</b>			
<b>Line Inductance = 146<math>\mu</math>H, PSCC = 5kA</b>			
<b>Frame Size:</b>	<b>5</b>	<b>6</b>	
<b>Product Code:</b>	20G-45-0600...	20G-46-0750...	20G-46-0900...
<b>Power Rating (kW):</b>	30	37	45
<b>Current Rating (A):</b>	60	75	90
<b>Harmonic No.</b>	<b>RMS Current (A)</b>		
1	56.17	70.92	85.37
3	0.00	0.00	0.01
5	19.19	23.53	25.76
7	1.53	1.28	1.00
9	0.00	0.01	0.01
11	4.21	5.06	5.55
13	0.57	1.01	1.93
15	0.00	0.01	0.00
17	1.77	2.05	2.00
19	0.70	1.01	1.41
21	0.00	0.01	0.00
23	0.88	0.95	0.73
25	0.59	0.76	0.85
27	0.00	0.01	0.00
29	0.44	0.43	0.29
31	0.43	0.51	0.44
33	0.00	0.01	0.01
35	0.22	0.21	0.27
37	0.30	0.31	0.20
39	0.01	0.00	0.00
40	0.00	0.00	0.00
<b>Total RMS Current (A):</b>	<b>60.06</b>	<b>74.95</b>	<b>90.00</b>
<b>THD: Current (%):</b>	<b>38.32</b>	<b>36.23</b>	<b>33.15</b>

<b>Drive Type: 3<math>\phi</math>, Fundamental Voltage = 400V</b>			
<b>Line Inductance = 146<math>\mu</math>H, PSCC = 5kA</b>			
<b>Frame Size:</b>	<b>7</b>		<b>8</b>
<b>Product Code:</b>	20G-47-1100...	20G-47-1500...	20G-48-1800...
<b>Power Rating (kW):</b>	55	75	90
<b>Current Rating (A):</b>	110	150	180
<b>Harmonic No.</b>	<b>RMS Current (A)</b>		
1	107.92	147.18	171.52
3	0.02	0.01	0.01
5	30.92	39.07	52.83
7	0.90	0.70	9.99
9	0.01	0.00	0.01
11	6.52	7.08	10.63
13	2.54	3.52	5.18
15	0.01	0.00	0.00
17	2.98	3.89	4.18
19	1.85	2.21	3.15
21	0.01	0.00	0.00
23	0.62	0.53	1.81
25	1.06	1.61	1.78
27	0.01	0.00	0.00
29	0.21	0.20	0.98
31	0.80	1.02	0.96
33	0.01	0.00	0.00
35	0.35	0.31	0.76
37	0.49	0.32	0.62
39	0.01	0.00	0.00
40	0.00	0.00	0.00
<b>Total RMS Current (A):</b>	<b>109.90</b>	<b>150.20</b>	<b>180.20</b>
<b>THD: Current (%):</b>	<b>32.12</b>	<b>31.34</b>	<b>32.29</b>



<b>Drive Type: 3<math>\phi</math>, Fundamental Voltage = 400V</b>			
<b>Line Inductance = 146<math>\mu</math>H, PSCC = 5kA</b>			
<b>Frame Size:</b>	<b>8</b>		<b>9</b>
<b>Product Code:</b>	20G-48-2200...	20G-48-2650...	20G-49-3200...
<b>Power Rating (kW):</b>	110	132	160
<b>Current Rating (A):</b>	220	265	320
<b>Harmonic No.</b>	<b>RMS Current (A)</b>		
1	210.98	254.93	310.15
3	0.02	0.01	0.00
5	59.43	68.62	74.99
7	11.83	13.41	19.22
9	0.01	0.02	0.01
11	11.96	12.82	13.05
13	6.72	7.78	9.16
15	0.00	0.02	0.01
17	4.13	3.84	3.49
19	3.55	3.65	3.37
21	0.00	0.02	0.01
23	1.69	1.86	2.39
25	1.69	1.60	1.78
27	0.00	0.02	0.01
29	1.20	1.48	1.57
31	0.96	1.14	1.41
33	0.00	0.02	0.01
35	0.95	0.98	0.90
37	0.79	0.91	0.86
39	0.00	0.02	0.01
40	0.00	0.00	0.00
<b>Total RMS Current (A):</b>	<b>220.00</b>	<b>264.80</b>	<b>320.10</b>
<b>THD: Current (%):</b>	<b>29.60</b>	<b>28.16</b>	<b>25.56</b>

<b>Drive Type: 3<math>\phi</math>, Fundamental Voltage = 400V</b>	
<b>Line Inductance = 146<math>\mu</math>H, PSCC = 5kA</b>	
<b>Frame Size:</b>	<b>10</b>
<b>Product Code:</b>	20G-410-3600...
<b>Power Rating (kW):</b>	180
<b>Current Rating (A):</b>	360
<b>Harmonic No.</b>	<b>RMS Current (A)</b>
1	350.04
3	0.02
5	79.71
7	22.93
9	0.00
11	12.78
13	9.62
15	0.00
17	3.59
19	3.14
21	0.01
23	2.70
25	2.09
27	0.00
29	1.48
31	1.42
33	0.01
35	0.99
37	0.85
39	0.01
40	0.00
<b>Total RMS Current (A):</b>	<b>360.10</b>
<b>THD: Current (%):</b>	<b>24.20</b>

## 11.3 North American & Canadian Compliance

### 11.3.1 North American Compliance

This product is certified under the US governments Occupational Safety and Health Administration's (OSHA), Nationally Recognised Testing Laboratory (NRTL) program. An NRTL is a private third-party organisation accredited by OSHA to test and certify products to national standards for compliance with North American requirements.

### 11.3.2 Canadian Compliance

Products have been approved to UL61800-5-1 – Adjustable Speed Electrical Power Drive Systems – Part 5-1: Safety Requirements – Electrical, Thermal and Energy, and to the Canadian Standard CSA 22.2 No. 274 - Adjustable speed drives.

### 11.3.3 North American & Canadian Compliance Information Perspective Short-Circuit Current (PSCC) Supply Ratings

The inverters have been designed to operate on the following PSCC supply ratings:

Frame Size	PSCC Rating ( $I_{rms}$ , Symmetrical Amperes, 480V Maximum)
2	50,000
3	50,000
4	50,000
5	50,000
6	50,000
7	50,000
8	50,000
9	50,000
10	50,000

Where inverters are to be used on higher rated supplies, refer to 'Chapter 7: Associated Equipment' for recommended AC line chokes.

#### Branch Circuit Protection

It is recommended that UL Listed fuses are installed upstream of the drive. Branch circuit protection must be provided in accordance with the latest edition of the National Electrical Code NEC/NFPA-70.

Refer to 'Chapter 7: Associated Equipment' for recommended fuse ratings.

#### Solid State Short-Circuit Protection

The inverter provides Solid-State Short-Circuit (output) protection.

#### Solid State Motor Overload Protection

The inverter provides Class 10 motor overload protection. The internal overload protection level (current limit) is 150% for 60 seconds.

Refer to 'DOC-0017-13, Chapter 10: Programming Your Application' for more information on the current limit operation and user adjustment.

An external motor overload protective device must be provided by the installer where the motor has a full-load Ampere rating of less than 50% of the drive output rating or when the **Disable Stall** trip is enabled; or when the **Stall time** parameter is increased above 480 seconds.

Refer to 'DOC-0017-13, Chapter 10: Programming Your Application' for more information on the stall trip.

Motor over temperature sensing is provided by the product when an external temperature sensor (of type PTC or NTC) is connected to the motor thermistor input on the control board.

### **Recommended Wire Sizes**

North American wire sizes (AWG) are based on NEC/NFPA-70 for ampacities of thermoplastic-insulated (75°C) copper conductors.

The wire sizes allow for an ampacity of 125% of the rated input and output amperes for motor branch-circuit conductors as specified in NEC/NFPA-70.

Refer to 'Chapter 6: Installation' for recommended wire sizes.

### **Field Wiring Temperature Rating**

Use minimum 75°C Copper conductors.

## 11.4 Environmental Compliance

### 11.4.1 REACH (Restriction, Evaluation, Authorisation & Restriction of Chemicals)

The Regulation (EC) No 1907/2006 of the European Parliament and of the Council of 18 December 2006 concerning the Registration, Evaluation, Authorization, and Restriction of Chemicals (REACH) entered into force on June 1, 2007.

Parker agrees with the purpose of REACH, which, is to ensure a high level of protection of human health and the environment. Parker is compliant with all applicable requirements of REACH.

The registration requirements do not apply to Parker since it is neither a manufacturer nor an importer of preparations into Europe. However, product (article) manufacturers or importers into Europe are obligated under Article 33 of REACH to inform recipients of any articles that contain chemicals on the Substances of Very High Concern (SVHC) candidate list above a 0.1% concentration (by weight per article).

Parker will continue to monitor the developments of the REACH legislation and will communicate with our customers according to the requirement above.

### 11.4.2 RoHS (Restriction of Hazardous Substances)

This product is in full compliance with RoHS Directive 2011/65/EU, including Commission Delegated Directive (EU) 2015/865 which amends Annex II, with respect to the following substances:

1. Lead (Pb)
2. Mercury (Hg)
3. Cadmium (Cd)
4. Hexavalent Chromium (Cr (VI))
5. Polybrominated Biphenyls (PBB)
6. Polybrominated Diphenyl Ethers (PBDE)
7. Bis(2-ethylhexyl) Phthalate (DEHP)
8. Butyl Benzyl Phthalate (BBP)
9. Dibutyl Phthalate (DBP)
10. Diisobutyl Phthalate (DIBP)

### 11.4.3 WEEE (Waste Electrical & Electronic Equipment)

Inverters fall under the category of "Waste Electrical and Electronic Equipment", and hence must not be disposed of with domestic waste:



These products must be collected separately, in accordance with local legislation and applicable laws. Parker Hannifin Manufacturing, together with local distributors and in accordance with EU directive 2012/19/EU, undertakes to withdraw and dispose of its products while fully respecting environmental considerations.

For more information about how to recycle your Parker supplied waste equipment, please contact your local Parker Repair Centre.

The packaging used in the safe transport of our products is environmentally compatible and should be taken for central disposal as secondary raw material.

## 12 AC20 Series Product Codes

	1		2	3		4		5	6
Order example	20G	-	1	2	-	0070	-	B	F

<b>1</b>	<b>Device Family</b>
20G	AC20 Series, Advanced, General Purpose AC Drive
<b>2</b>	<b>Voltage</b>
1	230Vac, Single Phase
3	230Vac, Three Phase
4	400Vac, Three Phase
<b>3 &amp; 4</b>	<b>Frame Size and Current Rating (Heavy Duty)</b>
	Frame Size - Current Rating (Power)
	<b>230Vac, Single Phase Supply Voltage</b>
2-0070	Frame 2 - 7A (1.5kW)
2-0100	Frame 2 - 10A (2.2kW)
	<b>230Vac, Single/Three Phase Supply Voltage</b>
2-0070	Frame 2 - 7A (1.5kW)
2-0100	Frame 2 - 10A (2.2kW)
3-0170	Frame 3 - 17A (4.0kW)
4-0210	Frame 4 - 21A (5.5kW)
5-0300	Frame 5 - 30A (7.5kW)
5-0400	Frame 5 - 40A (11kW)
	<b>400Vac, Three Phase Supply Voltage</b>
2-0040	Frame 2 - 4A (1.5kW)
2-0065	Frame 2 - 6.5A (2.2kW)
2-0090	Frame 2 - 9A (4.0kW)
3-0120	Frame 3 - 12A (5.5kW)
3-0170	Frame 3 - 17A (7.5kW)
4-0230	Frame 4 - 23A (11kW)
4-0320	Frame 4 - 32A (15kW)
5-0380	Frame 5 - 38A (18.5kW)
5-0440	Frame 5 - 44A (22kW)
5-0600	Frame 5 - 60A (30kW)
6-0750	Frame 6 - 75A (37kW)
6-0900	Frame 6 - 90A (45kW)
7-1100	Frame 7 - 110A (55kW)
7-1500	Frame 7 - 150A (75kW)
8-1800	Frame 8 - 180A (90kW)
8-2200	Frame 8 - 220A (110kW)
8-2650	Frame 8 - 265A (132kW)
9-3200	Frame 9 - 320A (160kW)
10-3600	Frame 10 - 360A (180kW)
<b>5</b>	<b>Brake Switch</b>
B	Brake Switch Fitted
<b>6</b>	<b>EMC Filter</b>
F	Category C3 Filtered

## 13 Technical Information

### 13.1 General Product Ratings

#### 13.1.1 Environment

<b>Operating Temperature:</b>	0°C to 40°C (derate output current above 40°C by 2% per °C, up to maximum of 45°C). <b>Anybus Comms Option not suitable for use in temperatures &gt;40°C.</b>
<b>Storage Temperature:</b>	-25°C to 55°C
<b>Shipping Temperature:</b>	-25°C to 70°C
<b>Altitude:</b>	0 – 1000m (derate output current above 1000m by 1% per 100m, up to maximum of 2000m)
<b>Humidity:</b>	Maximum 90% relative humidity, non-condensing
<b>Atmosphere:</b>	Non-flammable, non-corrosive, dust free
<b>Chemically Active Substances:</b>	Complies with C3 according to EN ISO 9223
<b>Vibration &amp; Shock:</b>	Vibration: <ul style="list-style-type: none"> <li>- 10 – 57Hz: Amplitude to 0.075mm</li> <li>- 57 – 150Hz: Acceleration to 10m/s<sup>2</sup></li> </ul> Shock: <ul style="list-style-type: none"> <li>- 5g for 30msec</li> </ul>
<b>Product Enclosure Rating:</b>	IP20 panel mount (UL: open-type).

#### 13.1.2 Safety

<b>Overvoltage Category:</b>	III (Control Module User Relay terminals: RL1A, RL1B, RL2A & RL2B are category II (230V TN))
<b>Pollution Degree:</b>	II (non-conductive pollution, except for temporary condensation)
<b>North America / Canada:</b>	Complies with the requirements of UL61800-5-1 as an open-type drive

#### 13.1.3 Earthing

<b>Earthing:</b>	Permanent earthing is mandatory for product installation: <ul style="list-style-type: none"> <li>- Use a copper productive earth conductor with a minimum 10mm<sup>2</sup> (8 AWG) cross-sectional area or, where not possible, install a 2<sup>nd</sup> conductor to a separate earth terminal.</li> <li>- The earth conductor must meet local requirements for a protective earth conductor.</li> </ul>
<b>Earth Leakage Current:</b>	>10mA (all models)

#### 13.1.4 Mains Supply

<b>Input Supply Details (TN &amp; IT):</b>	Products are suitable for use on TN supplies, with the exception of TN corner earthed distribution systems. Products are suitable for use on IT supplies when all Y-Cap & VDR connections to earth are removed.
<b>Prospective Short Circuit Current (PSCC):</b>	50kA: All models when fitted with specified UL fusing 5kA: All models when <b>not</b> fitted with specified UL fusing. Line currents are specified at this supply rating.



## 13.2 AC Line Fed Power Stack Ratings

### 13.2.1 1 $\phi$ , 230V Products

Power Supply = 1 $\phi$  220-240V  $\pm$ 10%, 50/60Hz  $\pm$ 10%, PSCC = 5kA

Motor power, output current and input current must not be exceeded under steady state operating conditions.

Minimum repetitive power up / power down cycle time = 10 mins.

Frame Size	Product Code	Motor Power (kW)	Output Current (A)	Input Current (A)	Est. Eff (%)	Switching Frequency (kHz) nom / max	AC Current Derate (%/kHz)
2	20G-12-0070...	1.5	7	14	95	4 / 10	6.0
	20G-12-0100...	2.2	10	20	96	4 / 10	6.3

### 13.2.2 3 $\phi$ , 230V Products

Power Supply = 3 $\phi$  220-240V  $\pm$ 10%, 50/60Hz  $\pm$ 10%, PSCC = 5kA

Motor power, output current and input current must not be exceeded under steady state operating conditions.

Minimum repetitive power up / power down cycle time = 10 mins.

Frame Size	Product Code	Motor Power (kW)	Output Current (A)	Input Current (A)	Est. Eff (%)	Switching Frequency (kHz) nom / max	AC Current Derate (%/kHz)
2	20G-32-0070...	1.5	7	7.8	95	4 / 10	6.0
	20G-32-0100...	2.2	10	11	95	4 / 10	6.2
3	20G-33-0170...	4	17	18.5	96	4 / 10	4.8
4	20G-34-0210...	5.5	21	22	97	4 / 10	2.2
5	20G-35-0300...	7.5	30	31	97	4 / 10	3.2
	20G-35-0400...	11	40	41	97	4 / 10	2.0

### 13.2.3 3 $\phi$ , 400V Products

Power Supply = 3 $\phi$  380-480V  $\pm$ 10%, 50/60Hz  $\pm$ 10%, PSCC = 5kA

Motor power, output current and input current must not be exceeded under steady state operating conditions.

Minimum repetitive power up / power down cycle time = 10 mins.

Frame Size	Product Code	Motor Power (kW)	Output Current (A)	Input Current (A)	Est. Eff (%)	Switching Frequency (kHz) nom / max	AC Current Derate (%/kHz)
2	20G-42-0040...	1.5	4	5	95	4 / 10	10.2
	20G-42-0065...	2.2	6.5	7.5	95	4 / 10	8.3
	20G-42-0090...	4	9	11	96	4 / 10	7.2
3	20G-43-0120...	5.5	12	14	96	4 / 10	7.8
	20G-43-0170...	7.5	17	18.5	96	4 / 10	6.3
4	20G-44-0230...	11	23	24	97	4 / 10	5.0
	20G-44-0320...	15	32	36.5	97	4 / 10	4.5
5	20G-45-0380...	18.5	38	44	97	4 / 10	4.0
	20G-45-0440...	22	44	51	98	4 / 10	5.3
	20G-45-0600...	30	60	70	96	4 / 10	5.8
6	20G-46-0750...	37	75	80	96	4 / 10	3.3
	20G-46-0900...	45	90	94	96	4 / 6	4.5
7	20G-47-1100...	55	110	120	97	3 / 8	5.0
	20G-47-1500...	75	150	160	97	3 / 8	4.6

Power Supply = 3 $\phi$  380-480V  $\pm$ 10%, 50/60Hz  $\pm$ 10%, PSCC = 5kA

Motor power, output current and input current must not be exceeded under steady state operating conditions.

Minimum repetitive power up / power down cycle time = 10 mins.

Frame Size	Product Code	Motor Power (kW)	Output Current (A)	Input Current (A)	Est. Eff (%)	Switching Frequency (kHz) nom / max	AC Current Derate (%/kHz)
8	20G-48-1800...	90	180	190	97	2 / 4	3.0
	20G-48-2200...	110	220	225	97	2 / 4	2.5
	20G-48-2650...	132	265	275	97	2 / 4	5.5
9	20G-49-3200...	160	320	330	98	2 / 4	6.0
10	20G-410-3600...	180	360	370	98	2 / 4	7.5

## 13.3 Internal Brake Switch Ratings

### 13.3.1 1 $\phi$ , 230V Products

DC Link Brake Switch Threshold = 382V

Frame Size	Product Code	Motor Power (kW)	Continuous		Peak (Instant)		Min Resistor Value ( $\Omega$ )
			Brake Current (A)	Power Diss (kW)	Brake Current (A)	Power Diss (kW)	
2	20G-12-0070...	1.5	3.9	1.5	4.8	1.8	80
	20G-12-0100...	2.2	4.8	1.8	4.8	1.8	80

Note: Peak (Instant) = Maximum 20sec, 30% 'on' duty (except where this value is the same as the continuous rating)

### 13.3.2 3 $\phi$ , 230V Products

DC Link Brake Switch Threshold = 382V

Frame Size	Product Code	Motor Power (kW)	Continuous		Peak (Instant)		Min Resistor Value ( $\Omega$ )
			Brake Current (A)	Power Diss (kW)	Brake Current (A)	Power Diss (kW)	
2	20G-32-0070...	1.5	3.9	1.5	4.8	1.8	80
	20G-32-0100...	2.2	4.8	1.8	4.8	1.8	80
3	20G-33-0170...	4	10.5	4.0	12.7	4.9	30
4	20G-34-0210...	5.5	12.7	4.9	12.7	4.9	30
5	20G-35-0300...	7.5	19.6	7.5	25.5	9.7	15
	20G-35-0400...	11	28.8	11.0	34.7	13.3	11

Note: Peak (Instant) = Maximum 20sec, 30% 'on' duty (except where this value is the same as the continuous rating)

### 13.3.3 3 $\phi$ , 400V Products

DC Link Brake Switch Threshold = 764V							
Frame Size	Product Code	Motor Power (kW)	Continuous		Peak (Instant)		Min Resistor Value ( $\Omega$ )
			Brake Current (A)	Power Diss (kW)	Brake Current (A)	Power Diss (kW)	
2	20G-42-0040...	1.5	2.0	1.5	8.0	6.1	95
	20G-42-0065...	2.2	2.9	2.2	8.5	6.5	90
	20G-42-0090...	4	5.2	4.0	8.5	6.5	90
3	20G-43-0120...	5.5	7.2	5.5	8.5	6.5	90
	20G-43-0170...	7.5	8.5	6.5	8.5	6.5	90
4	20G-44-0230...	11	14.4	11.0	15.3	11.7	50
	20G-44-0320...	15	19.6	15.0	25.5	19.5	30
5	20G-45-0380...	18.5	24.2	18.5	25.5	19.5	30
	20G-45-0440...	22	25.5	19.5	25.5	19.5	30
	20G-45-0600...	30	30.6	23.3	30.6	23.3	25
6	20G-46-0750...	37	48.4	37.0	54.6	41.7	14
	20G-46-0900...	45	54.6	41.7	54.6	41.7	14
7	20G-47-1100...	55	54.6	41.7	54.6	41.7	14
	20G-47-1500...	75	69.5	53.1	69.5	53.1	11
8	20G-48-1800...	90	109.1	83.3	109.1	83.3	7
	20G-48-2200...	110	109.1	83.3	109.1	83.3	7
	20G-48-2650...	132	172.8	132.0	191.0	146.0	4
9	20G-49-3200...	160	209.4	160.0	254.7	194.6	3
10	20G-410-3600...	180	235.6	180.0	254.7	194.6	3

Note: Peak (Instant) = Maximum 20sec, 30% 'on' duty (except where this value is the same as the continuous rating)

## 13.4 Control Board Ratings

### 13.4.1 Analogue Inputs

<b>Terminal Idents:</b>	AI1, AI2, referenced to 0V
<b>Type:</b>	Voltage Modes: <ul style="list-style-type: none"> <li>- <math>\pm 10V</math></li> <li>- 0 – 10V</li> </ul> Current Modes: <ul style="list-style-type: none"> <li>- 0 – 20mA</li> <li>- 4 – 20mA (with wire break detection)</li> </ul>
<b>Maximum Input Voltage:</b>	$\pm 30V$
<b>Input Impedance:</b>	Voltage Mode: 10k $\Omega$ Current Mode: <5.5V drop @ 20mA
<b>Resolution:</b>	12 Bit
<b>Isolated:</b>	No
<b>Overcurrent Protection:</b>	Yes (Current Mode only)
<b>Sample / Update Rate:</b>	1msec

### 13.4.2 Analogue Outputs

<b>Terminal Idents:</b>	AO1, AO2, referenced to 0V
<b>Type:</b>	Voltage Mode: - 0 – 10V Current Mode: - 0 – 20mA
<b>Maximum Output Current:</b>	20mA
<b>Load Impedance:</b>	Voltage Mode: Max current = 20mA Current Mode: Max voltage = 10V
<b>Typical Settling Time:</b>	2.5msec (0 to 90%)
<b>Resolution:</b>	11 Bit
<b>Isolated:</b>	No
<b>Short Circuit Protection:</b>	Yes
<b>Sample / Update Rate:</b>	1msec

<b>Terminal Idents:</b>	AO3, referenced to 0V
<b>Type:</b>	Voltage Mode: - $\pm 10V$ - 0 – 10V
<b>Maximum Output Current:</b>	$\pm 10mA$
<b>Typical Settling Time:</b>	2.5msec (0 to 90%)
<b>Resolution:</b>	11 Bit
<b>Isolated:</b>	No
<b>Short Circuit Protection:</b>	Yes
<b>Sample / Update Rate:</b>	1msec

### 13.4.3 Digital Inputs

<b>Terminal Idents:</b>	DX1, DX2, DX3, DI4, DI5, DI6, DI7, DI8, DI9, DI10, referenced to 0V
<b>Nominal Input Voltage:</b>	24V
<b>Maximum Input Voltage:</b>	+ 30V
<b>Input Thresholds:</b>	Typical threshold = 10V: - Low state <5V - High state >15V
<b>Input Current:</b>	>2.5mA in High state Typically: 5mA @ 24V
<b>Selectable Pull-Ups:</b>	Common to all dedicated digital inputs (DI4, DI5, DI6, DI7, DI8, DI9, DI10)
<b>Pull-Up Current Consumption:</b>	>2.5mA in Low state Typically: 3.5mA @ 0V
<b>Isolated:</b>	No
<b>Sample Interval:</b>	1msec

### 13.4.4 Digital Outputs

<b>Terminal Idents:</b>	DX1, DX2, DX3, referenced to 0V
<b>Nominal Output Voltage:</b>	23V
<b>Minimum Output Voltage:</b>	18V @ 50mA
<b>Maximum Output Current:</b>	50mA (Each output, or Total outputs combined)
<b>Isolated:</b>	No
<b>Short Circuit Protection:</b>	Yes

### 13.4.5 Relay Outputs

<b>Terminal Idents:</b>	RL1A, RL1B, RL2A, RL2B
<b>Maximum Contact Voltage:</b>	230Vac (Overvoltage Category II, TN) / 30Vdc
<b>Maximum Contact Current:</b>	2Arms

### 13.4.6 Motor Thermistor Input

<b>Terminal Idents:</b>	TH1, TH2
<b>Compatible Thermistors:</b>	PTC & NTC
<b>Trip Threshold:</b>	Rising resistance: 2500 $\Omega$ to 2800 $\Omega$ Falling resistance: 1000 $\Omega$ to 1200 $\Omega$
<b>Response Time:</b>	10secs
<b>Thermistor Self Heating:</b>	<15mW @ rising resistance threshold
<b>Isolated:</b>	No – thermistor wiring requires double or reinforced insulation to live voltages

### 13.4.7 User +24V Output

<b>Terminal Idents:</b>	24V referenced to 0V
<b>Nominal Output Voltage:</b>	23V
<b>Minimum Output Voltage:</b>	20V @ 50mA
<b>Maximum Output Current:</b>	50mA
<b>Isolated:</b>	No
<b>Over Current Protection:</b>	Yes

### 13.4.8 External +24V Auxiliary Input

Allows for the partial power-up of the product without mains power applied, for programming of the drive using the DSELite programming tool through the Ethernet port, or communication with the drive through the Anybus Comms option.  $\mu$ SD Card port, display, keypads and digital I/O are also active.

<b>Terminal Idents:</b>	0V, 24V
<b>Input Voltage:</b>	24V +/-10% (up to a maximum ambient temperature of 40°C) 24V +5 / -10% (up to a maximum ambient temperature of 45°C)
<b>Indicative Input Current:</b>	@Nominal 24V: - Control Board only: 45mA - Control Board with EtherCAT comms option fitted only: 85mA
<b>Isolated:</b>	No
<b>Over Voltage Protection:</b>	No
<b>Reverse Voltage Protection:</b>	No

### 13.4.9 STO Inputs

<b>Terminal Idents:</b>	STOA, STOB, referenced to 0V
<b>Nominal Input Voltage:</b>	24V PELV (with energy source class 3, according to IEC 62368-1)
<b>Maximum Input Voltage:</b>	25.2V (26.4V in a maximum operating ambient of 40°C)
<b>Recommended Input Voltage for Logic Low Level:</b>	0V – 5V (or open circuit)
<b>Recommended Input Voltage for Logic High Level:</b>	15V – 24V
<b>Indetermined Input Range:</b>	5V – 15V, function is undefined
<b>Typical Input Current:</b>	9mA @ 24V
<b>STO Input Operability:</b>	Always Active (i.e., STO cannot be disabled by the drive firmware)
<b>STO User Input A Logic Level:</b>	0V or open circuit = STO Activated 24V = STO Disabled
<b>STO User Input B Logic Level:</b>	0V or open circuit = STO Activated 24V = STO Disabled
<b>Isolation:</b>	Channel A & B to SELV: Galvanic Isolation. Channel A to Channel B: Non-isolated

## 13.5 Encoder Feedback Option Card Ratings

### 13.5.1 Encoder Inputs

<b>Terminal Idents:</b>	A, /A, B, /B
<b>Nominal Input Voltage:</b>	5V to 24V
<b>Maximum Input Voltage:</b>	+/- 30V
<b>Input Threshold:</b>	Selectable: <ul style="list-style-type: none"> <li>- Low level = 1.8V (suitable for 5V TTL, RS422, RS485 level input signals)</li> <li>- High level = 6.5V (suitable for 10V to 24V HTL level input signals)</li> </ul>
<b>Input Current:</b>	Nominally 8mA @ 24V
<b>Signaling Type:</b>	Single Ended
<b>Counting Modes:</b>	Quadrature Clock & Direction Clock
<b>Maximum Count Frequency:</b>	250kHz
<b>Duty Cycle:</b>	50% ± 10%
<b>Quadrature Angle:</b>	90° ± 45°
<b>Isolated:</b>	Galvanic isolation from: <ul style="list-style-type: none"> <li>- Input terminals to inverter 0V</li> <li>- Input to input terminals (A to B channels)</li> </ul>

### 13.5.2 Power Supply Output

<b>Terminal Idents:</b>	V+, referenced to V-
<b>Type:</b>	Selectable Output Voltage: <ul style="list-style-type: none"> <li>- 5V</li> <li>- 12V</li> <li>- 15V</li> <li>- 20V</li> </ul>
<b>Maximum Output Current:</b>	If 1x option card <b>only</b> fitted, output limited to 1.6W / 250mA: <ul style="list-style-type: none"> <li>- 250mA @ 5V</li> <li>- 133mA @ 12V</li> <li>- 107mA @ 15V</li> <li>- 80mA @ 20V</li> </ul> If 2x option cards fitted, output limited to 0.8W / 125mA (each): <ul style="list-style-type: none"> <li>- 125mA @ 5V</li> <li>- 67mA @ 12V</li> <li>- 53mA @ 15V</li> <li>- 40mA @ 20V</li> </ul>
<b>Isolated:</b>	Galvanic isolation from: <ul style="list-style-type: none"> <li>- Output terminal to inverter 0V</li> <li>- Output terminal to user 24V supply</li> </ul>
<b>Over Current Protection:</b>	Yes



## 13.6 GPIO Option Card Ratings

### 13.6.1.1 Analogue Inputs

<b>Terminal Idents:</b>	AI3, AI4, referenced to 0V
<b>Type:</b>	Voltage Modes: - $\pm 10V$ - 0 – 10V
<b>Maximum Input Voltage:</b>	$\pm 30V$
<b>Input Impedance:</b>	10k $\Omega$
<b>Resolution:</b>	15 Bit
<b>Isolated:</b>	No
<b>Sample / Update Rate:</b>	1msec

### 13.6.2 Analogue Outputs

<b>Terminal Idents:</b>	AO4, referenced to 0V
<b>Type:</b>	Voltage Mode: - $\pm 10V$ - 0 – 10V
<b>Maximum Output Current:</b>	$\pm 10mA$
<b>Typical Settling Time:</b>	2.5msec (0 to 90%)
<b>Resolution:</b>	14 Bit
<b>Isolated:</b>	No
<b>Short Circuit Protection:</b>	Yes
<b>Sample / Update Rate:</b>	1msec

### 13.6.3 Digital Input

<b>Terminal Idents:</b>	DX11, referenced to 0V
<b>Nominal Input Voltage:</b>	24V
<b>Maximum Input Voltage:</b>	+ 30V
<b>Input Thresholds:</b>	Typical threshold = 10V: - Low state <5V - High state >15V
<b>Input Current:</b>	>2.5mA in High state Typically: 5mA @ 24V
<b>Isolated:</b>	No
<b>Sample Interval:</b>	1msec

### 13.6.4 Digital Output

<b>Terminal Idents:</b>	DX11, referenced to 0V
<b>Nominal Output Voltage:</b>	22V
<b>Minimum Output Voltage:</b>	18V @ 50mA
<b>Maximum Output Current:</b>	50mA Note: Total consumption of all Base Control Board Digital Outputs DX1, DX2, DX3, User +24V Output, and Option Card DX11 must not exceed <b>120mA</b> .
<b>Isolated:</b>	No
<b>Short Circuit Protection:</b>	Yes

### 13.6.5 +10V Reference Voltage Output

<b>Terminal Idents:</b>	+10V, referenced to 0V
<b>Maximum Output Current:</b>	± 10mA
<b>Accuracy:</b>	10V ±360mV (Typically 150mV)
<b>Isolated:</b>	No
<b>Over Current Protection:</b>	Yes Note: If there is a short circuit on the +10V reference output, the -10V supply will collapse.

### 13.6.6 -10V Reference Voltage Output

<b>Terminal Idents:</b>	-10V, referenced to 0V
<b>Maximum Output Current:</b>	± 10mA
<b>Accuracy:</b>	-10V ±560mV (Typically 200mV)
<b>Isolated:</b>	No
<b>Over Current Protection:</b>	Yes Note: If there is a short circuit on the -10V reference output, the +10V supply will still be active.

# Appendix A: Power Stack Circuit Overview

## 1 $\phi$ , 230V Products

### Frame 2:

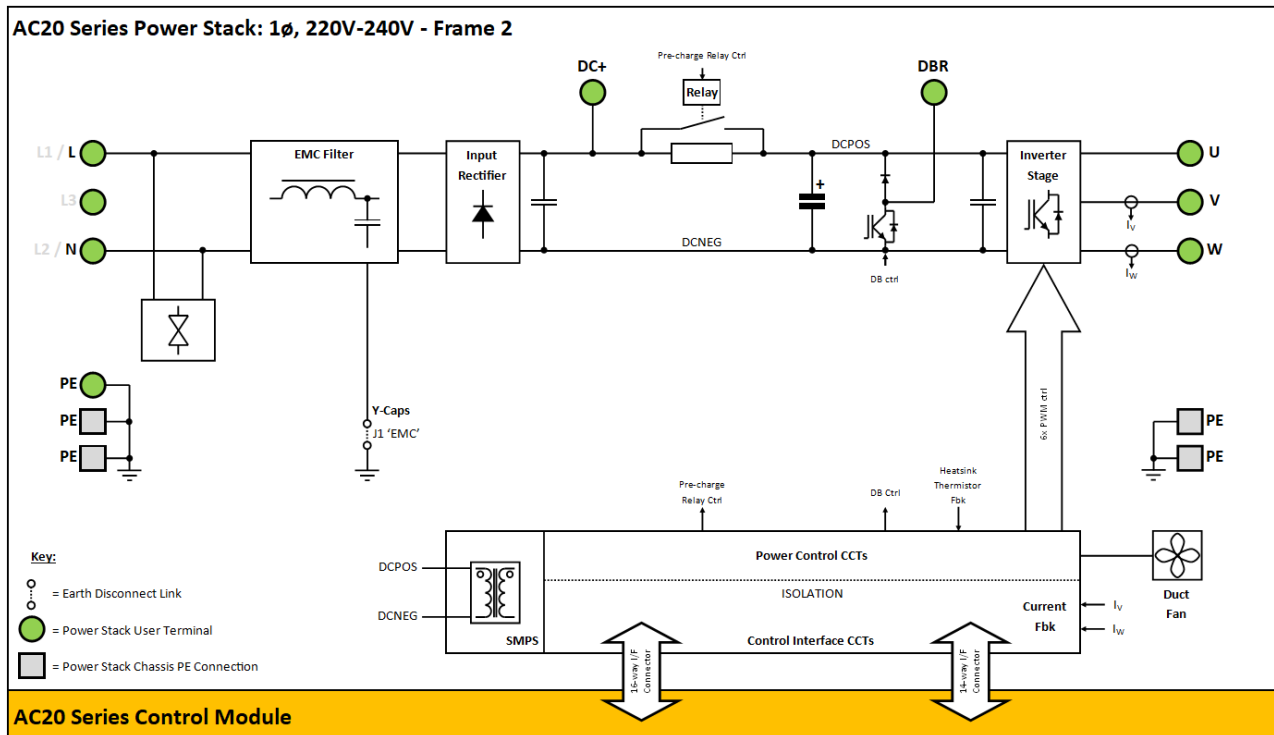

## 3 $\phi$ , 230V Products

### Frame 2:

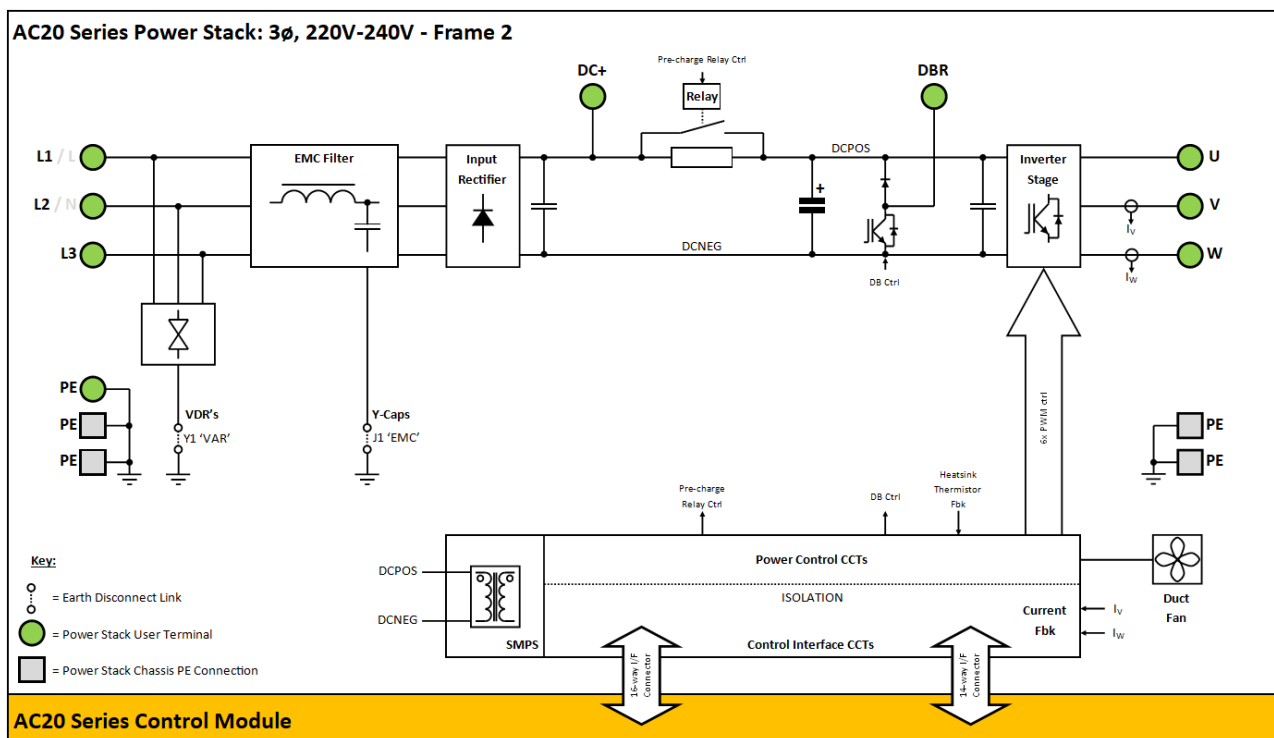

**Frame 3:**

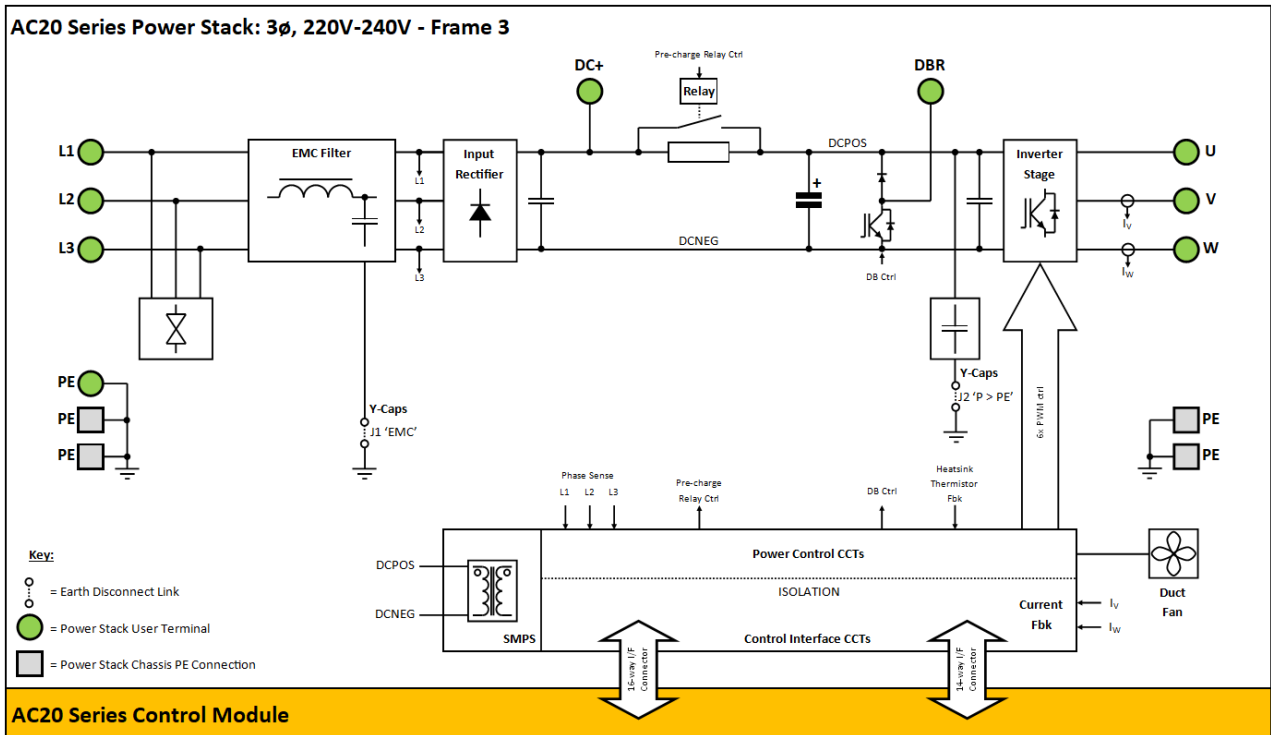

**Frame 4:**

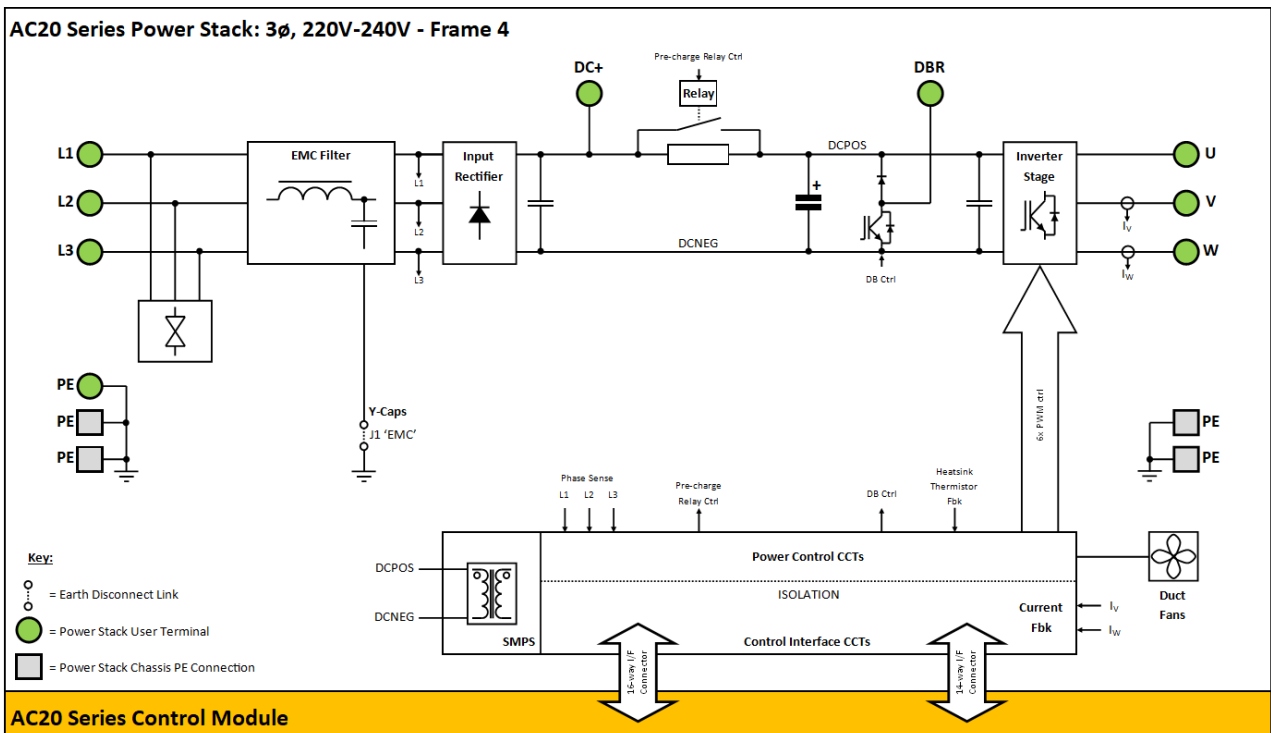

**Frame 5:**

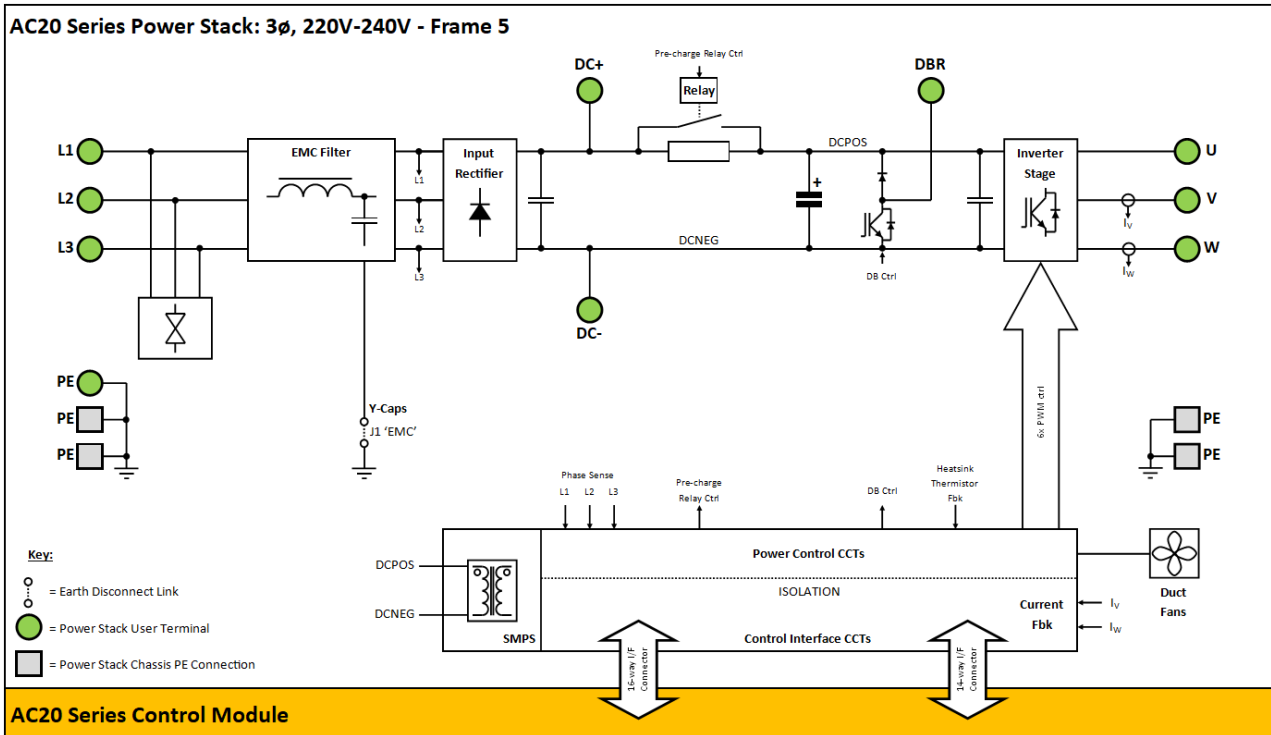

**3 $\phi$ , 400V Products  
Frame 2:**

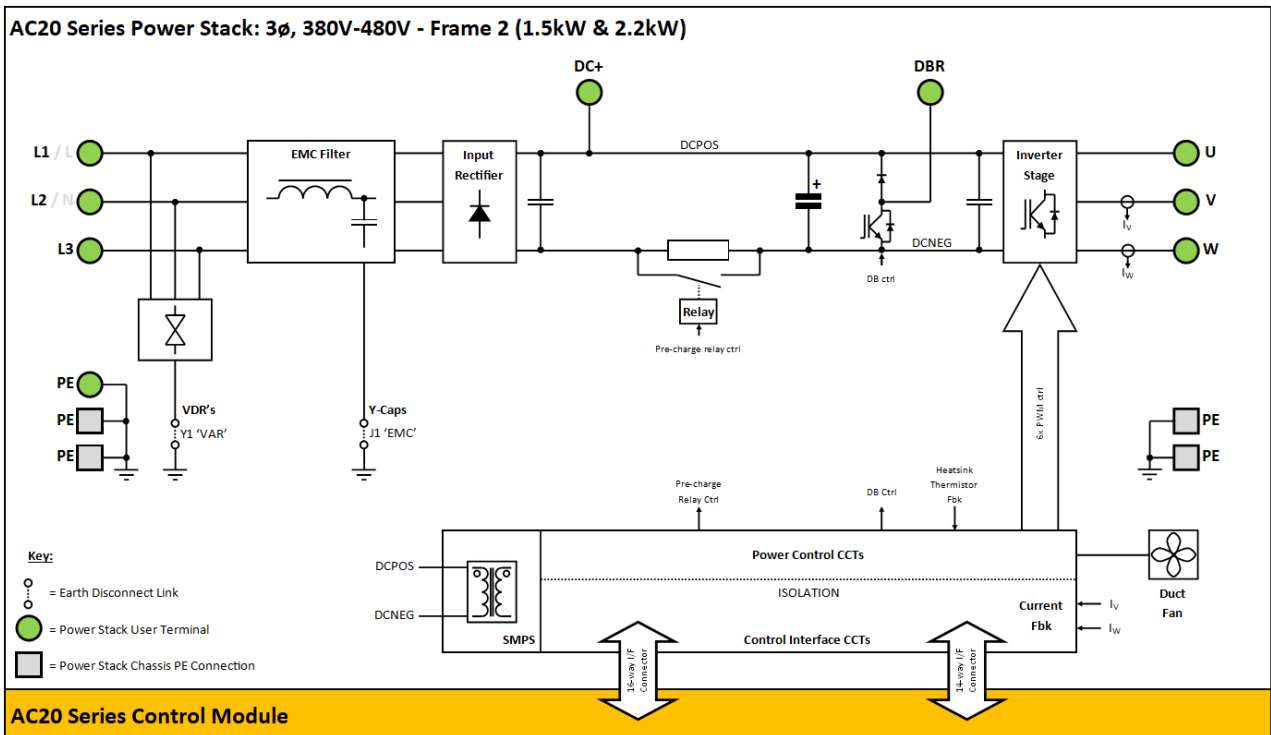

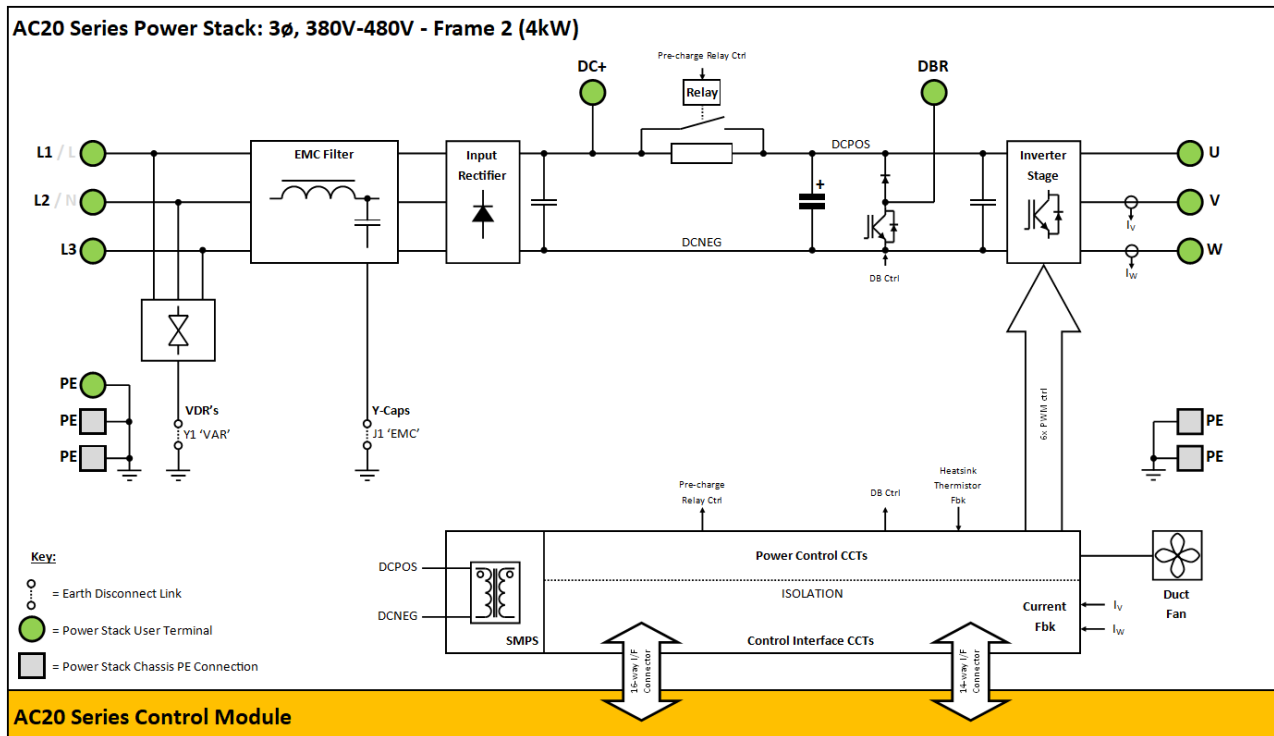

**Frame 3:**

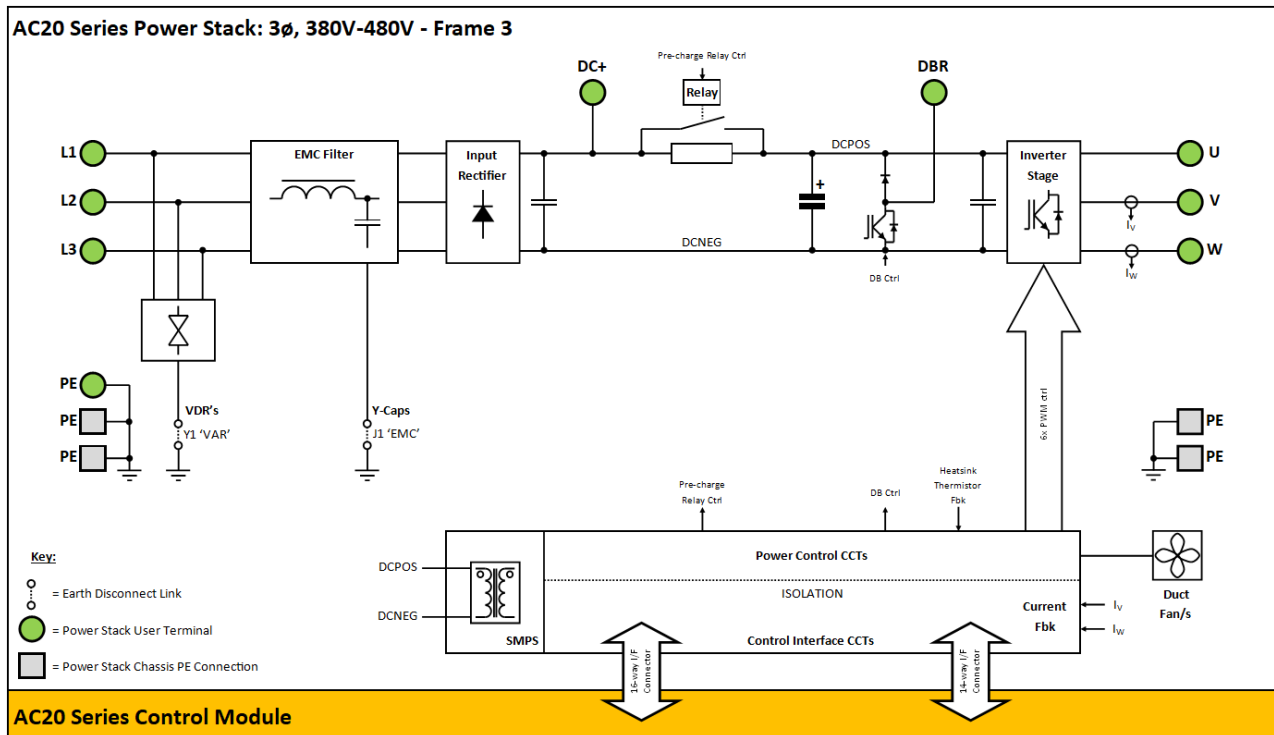

Frame 4:

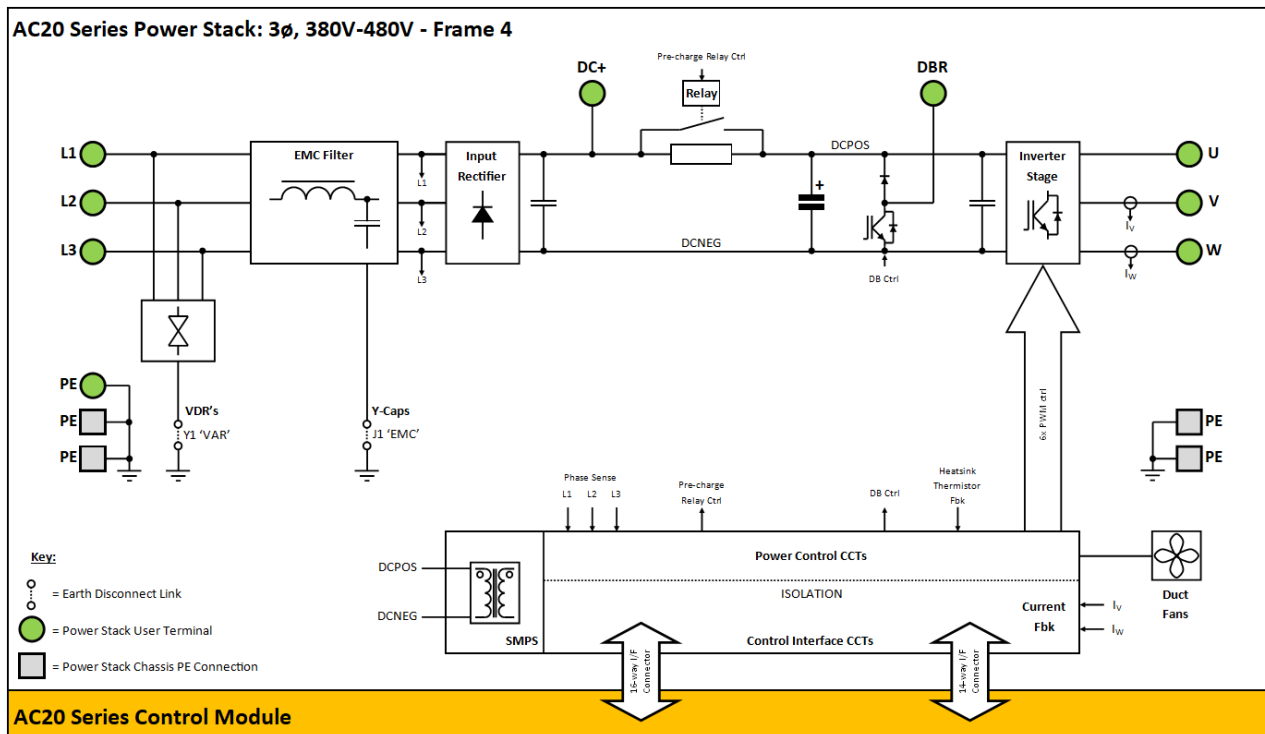

Frame 5:

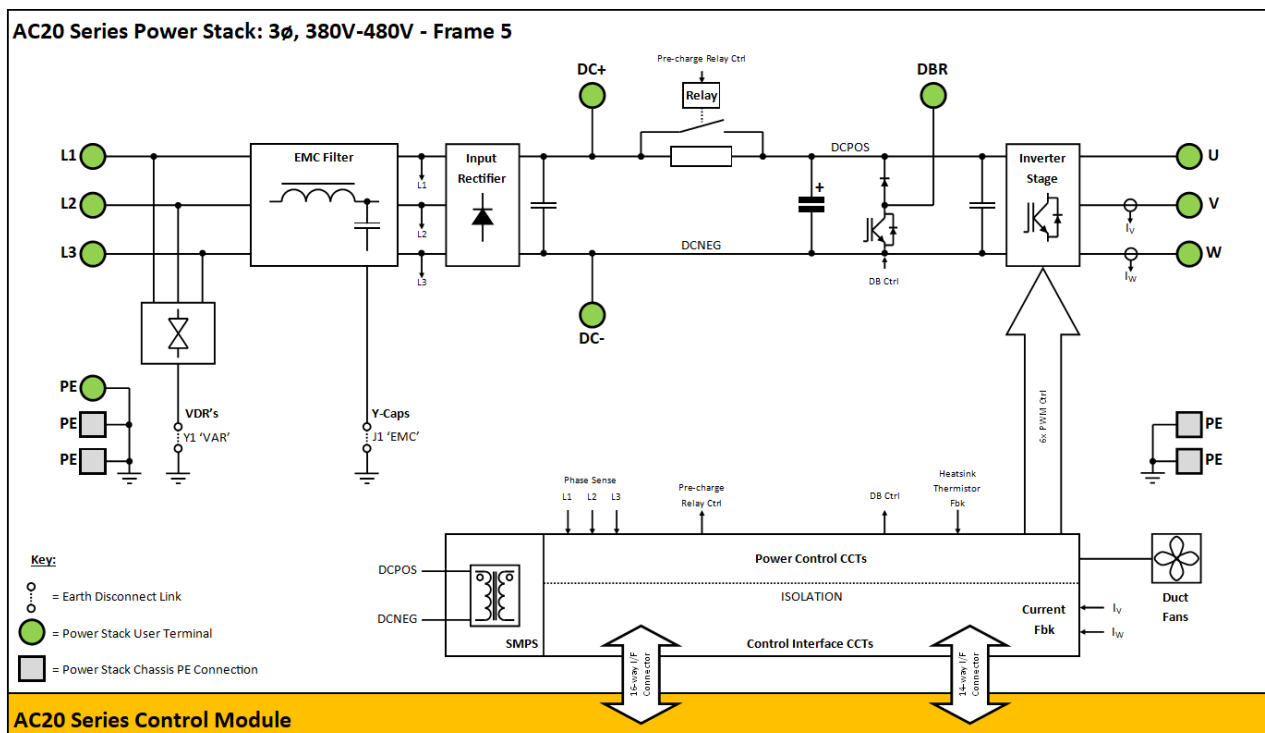



**Frame 6:**

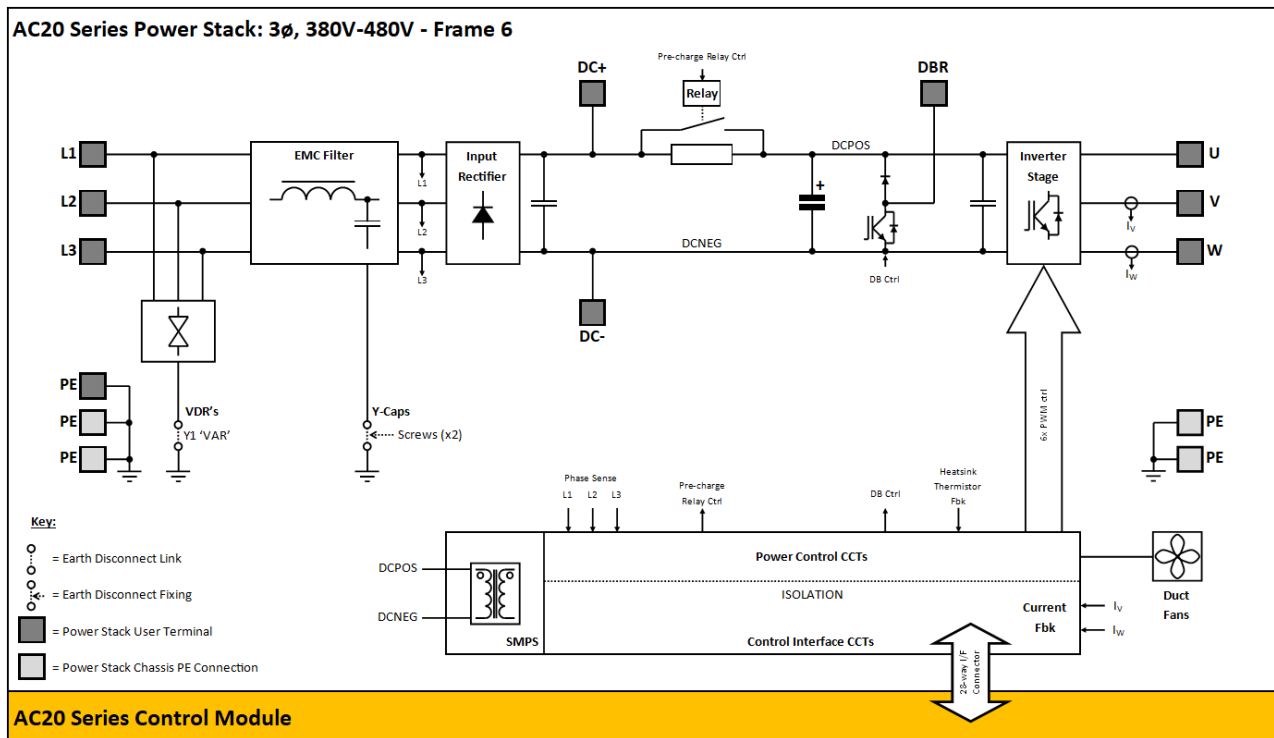

**Frames 7 & 8:**

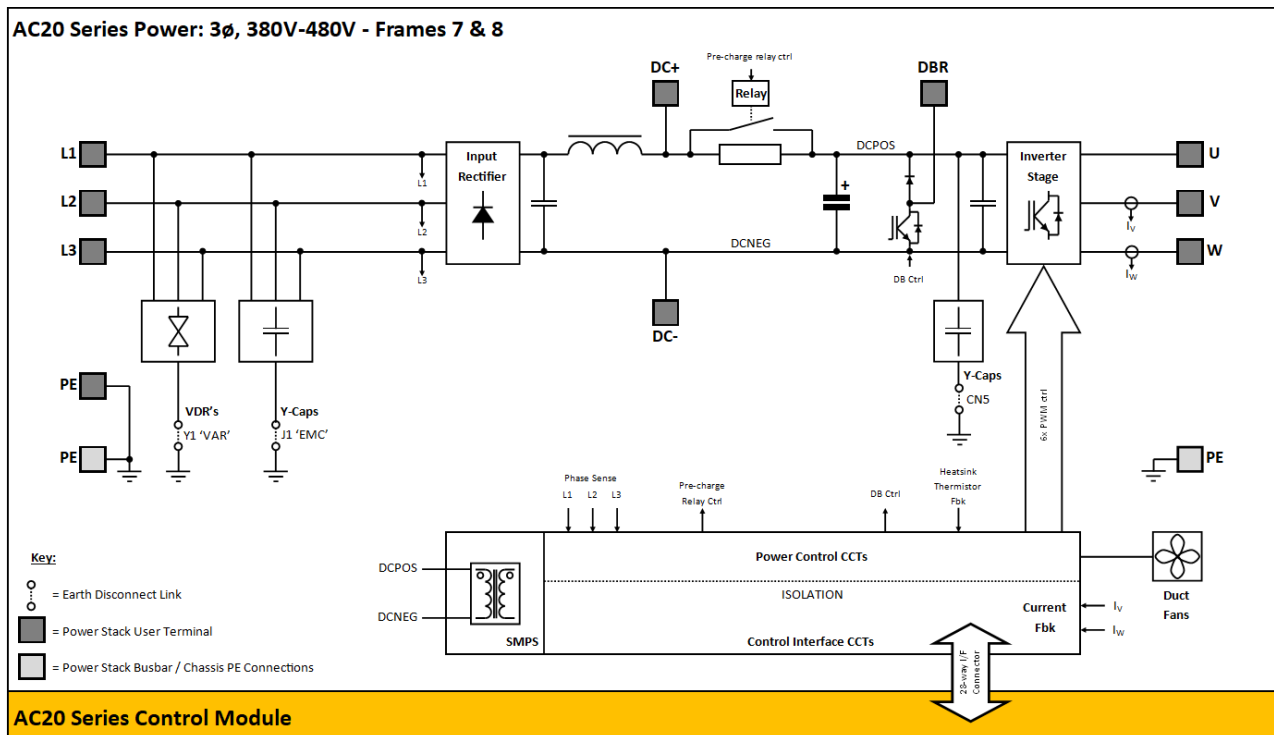

Frame 9:

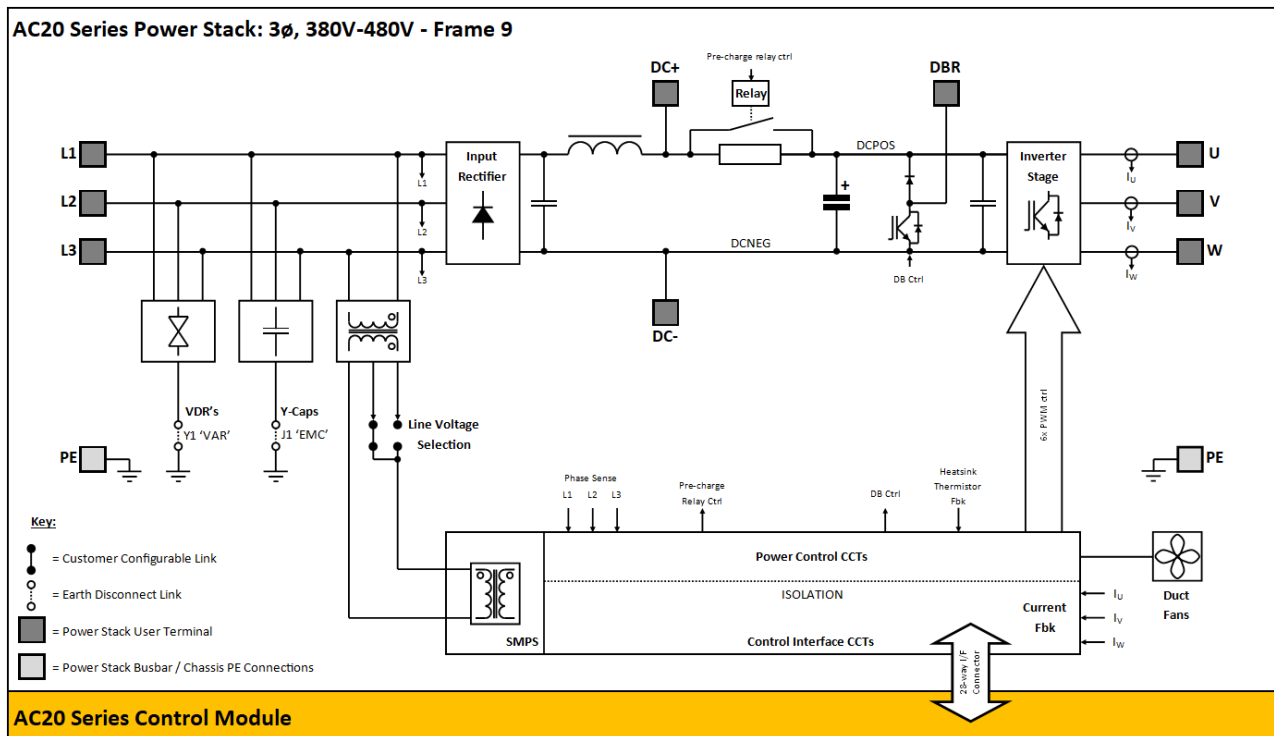

Frame 10:

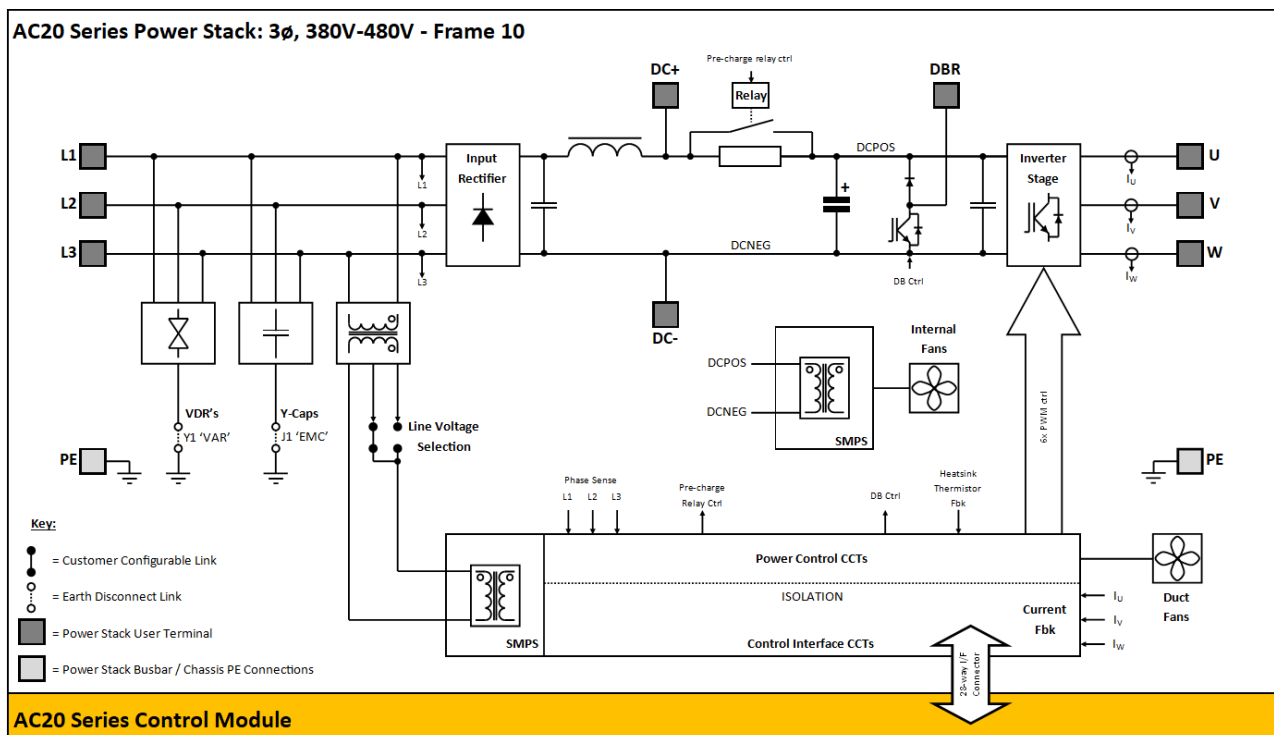

[www.parker.com](http://www.parker.com)



**European Headquarters**  
La Tuilière 6, 1163 Etoy,  
Switzerland  
Tel: +41 21 821 85 00

Your authorized distributor