

# 650S

SERIES



# 650S



**Product Manual**



# 650S AC Drive

Frame 1, 2 & 3

**HA500924U001 I S S U E 1**

Compatible with Version 1.x Software onwards

© 2009 Parker Hannifin Ltd.

All rights strictly reserved. No part of this document may be stored in a retrieval system, or transmitted in any form or by any means to persons not employed by a Parker SSD Drives company without written permission from Parker SSD Drives, a division of Parker Hannifin Ltd. Although every effort has been taken to ensure the accuracy of this document it may be necessary, without notice, to make amendments or correct omissions. Parker SSD Drives cannot accept responsibility for damage, injury, or expenses resulting therefrom.

## WARRANTY

Parker SSD Drives warrants the goods against defects in design, materials and workmanship for the period of 24 months from the date of manufacture, or 12 months from the date of delivery (whichever is the longer period), on the terms detailed in Parker SSD Drives Standard Conditions of Sale IA500504.

Parker SSD Drives reserves the right to change the content and product specification without notice.

**Product Manual**

# Safety Information



**FAILURE OR IMPROPER SELECTION OR IMPROPER USE OF THE PRODUCTS DESCRIBED HEREIN OR RELATED ITEMS CAN CAUSE DEATH, PERSONAL INJURY AND PROPERTY DAMAGE.**

- This document and other information from Parker-Hannifin Corporation, its subsidiaries and authorized distributors provide product or system options for further investigation by users having technical expertise.
- The user, through its own analysis and testing, is solely responsible for making the final selection of the system and components and assuring that all performance, endurance, maintenance, safety and warning requirements of the application are met. The user must analyze all aspects of the application, follow applicable industry standards, and follow the information concerning the product in the current product catalog and in any other materials provided from Parker or its subsidiaries or authorized distributors.
- To the extent that Parker or its subsidiaries or authorized distributors provide component or system options based upon data or specifications provided by the user, the user is responsible for determining that such data and specifications are suitable and sufficient for all applications and reasonably foreseeable uses of the components or systems.

# Safety Information



## Requirements

**IMPORTANT** Please read this information **BEFORE** installing the equipment.

### Intended Users

This manual is to be made available to all persons who are required to install, configure or service equipment described herein, or any other associated operation.

The information given is intended to highlight safety issues, and to enable the user to obtain maximum benefit from the equipment.

Complete the following table for future reference detailing how the unit is to be installed and used.

INSTALLATION DETAILS			
<b>Model Number</b> <i>(see product label)</i>		<b>Where installed</b> <i>(for your own information)</i>	
<b>Unit used as a:</b> <i>(refer to "Certification")</i>	<input type="radio"/> Component <input type="radio"/> Relevant Apparatus	<b>Unit fitted:</b>	<input checked="" type="checkbox"/> Enclosure

### Application Area

The equipment described is intended for industrial motor speed control utilising AC synchronous permanent magnet machines



### Personnel

Installation, operation and maintenance of the equipment should be carried out by qualified personnel. A qualified person is someone who is technically competent and familiar with all safety information and established safety practices; with the installation process, operation and maintenance of this equipment; and with all the hazards involved.



# Safety Information

## Product Warnings

 <p><b>Caution</b> Risk of electric shock</p>	 <p><b>Caution</b> Refer to documentation</p>	 <p><b>Earth/Ground</b> Protective Conductor Terminal</p>
--	--	--

## Hazards

### **DANGER! - Ignoring the following may result in injury**

1. This equipment can endanger life by exposure to rotating machinery and high voltages.
2. The equipment must be permanently earthed due to the high earth leakage current, and the drive motor must be connected to an appropriate safety earth.
3. Ensure all incoming supplies are isolated before working on the equipment. Be aware that there may be more than one supply connection to the drive.
4. There may still be dangerous voltages present at power terminals (motor output, supply input phases, DC bus and the brake, where fitted) when the motor is at standstill or is stopped.
5. For measurements use only a meter to IEC 61010 (CAT III or higher). Always begin using the highest range. CAT I and CAT II meters must not be used on this product.
6. Allow at least 10 minutes for the drive's capacitors to discharge to safe voltage levels (<50V). Use the specified meter capable of measuring up to 1000V dc & ac rms to confirm that less than 50V is present between all power terminals and between power terminals and earth.
7. Unless otherwise stated, this product must NOT be dismantled. In the event of a fault the drive must be returned. Refer to "Routine Maintenance and Repair".

# Safety Information



**WARNING! - Ignoring the following may result in injury or damage to equipment**

## SAFETY

Where there is conflict between EMC and Safety requirements, personnel safety shall always take precedence.

- Never perform high voltage resistance checks on the wiring without first disconnecting the drive from the circuit being tested.
- Whilst ensuring ventilation is sufficient, provide guarding and /or additional safety systems to prevent injury or damage to equipment.
- When replacing a drive in an application and before returning to use, it is essential that all user defined parameters for the product's operation are correctly installed.
- All control and signal terminals are SELV, i.e. protected by double insulation. Ensure all external wiring is rated for the highest system voltage.
- Thermal sensors contained within the motor must have at least basic insulation.
- All exposed metalwork in the Drive is protected by basic insulation and bonded to a safety earth.
- RCDs are not recommended for use with this product but, where their use is mandatory, only Type B RCDs should be used.

---

## EMC

- In a domestic environment this product may cause radio interference in which case supplementary mitigation measures may be required.
- This is a product of the restricted sales distribution class according to IEC 61800-3.
- This equipment contains electrostatic discharge (ESD) sensitive parts. Observe static control precautions when handling, installing and servicing this product.
- It is designated as “professional equipment” as defined in EN61000-3-2. Permission of the supply authority shall be obtained before connection to the low voltage supply.



# Safety Information

## CAUTION!

### APPLICATION RISK

- The specifications, processes and circuitry described herein are for guidance only and may need to be adapted to the user's specific application. We can not guarantee the suitability of the equipment described in this Manual for individual applications.
- It is advised that motors with significantly lower voltage ratings than the supply voltage are **NOT** used with the drive.

---

### RISK ASSESSMENT

Under fault conditions, power loss or unintended operating conditions, the drive may not operate as intended. In particular:

- Stored energy might not discharge to safe levels as quickly as suggested, and can still be present even though the drive appears to be switched off
- The motor's direction of rotation might not be controlled
- The motor speed might not be controlled
- The motor might be energised

A drive is a component within a drive system that may influence its operation or effects under a fault condition. Consideration must be given to:

- Stored energy
  - Supply disconnects
  - Sequencing logic
  - Unintended operation
-

# Contents

---

- Chapter 1: Getting Started..... 1-1**
  - Introduction..... 1-2
  - Equipment Inspection ..... 1-3
  - Storage and Packaging..... 1-3
  - About this Manual..... 1-3
- Chapter 2: Product Overview ..... 2-1**
  - Component Identification ..... 2-2
- Chapter 3: Installing the Drive..... 3-1**
  - Mechanical Installation..... 3-2
    - Mounting the Drive..... 3-3
    - Ventilation ..... 3-3
  - Electrical Installation..... 3-4
    - Wiring Instructions..... 3-4
  - Optional Equipment..... 3-11
- Chapter 4: Operating the Drive ..... 4-1**
  - Pre-Operation Checks..... 4-2
  - Initial Start-up Routines..... 4-3
    - Local Control Operation ..... 4-4
    - Remote Control Operation..... 4-5
    - Set-up ..... 4-6
  - Tuning the Drive to Your System..... 4-7
- Chapter 5: The Keypad..... 5-1**
  - The 6511 Keypad ..... 5-2
  - Controlling the Drive using the Keypad..... 5-3
    - Control Key Definitions ..... 5-3
    - Display Indications ..... 5-4
    - Drive Status Indications..... 5-5
    - The DIAGNOSTICS Menu ..... 5-6
  - The Menu System..... 5-7
    - How To Change a Parameter Value..... 5-8
  - Special Menu Features ..... 5-9
    - Resetting to Factory Defaults (2-button reset) ..... 5-9
    - Changing the Drive Operating Frequency ..... 5-9

- Selecting Local or Remote Control ..... 5-10
- Password Protection..... 5-11
- Selecting the Menu Detail..... 5-12

- Chapter 6: Programming Your Application ..... 6-1**
  - Programming Your Application ..... 6-2
  - MMI Parameters..... 6-2
    - MMI Parameters Table ..... 6-3
    - Configuring Terminals 9 & 10 (Digital Input/Output)..... 6-28
    - PID - Tuning Your Drive ..... 6-30
    - Auto Restart ..... 6-31
    - Minimum Speed Mode..... 6-32
    - Product-Related Default Values ..... 6-32
      - \* Frequency Dependent Parameters ..... 6-33
      - \*\* Power Dependent Parameters ..... 6-34
- Chapter 7: Trips and Fault Finding..... 7-1**
  - Trips ..... 7-2
  - Using the Keypad to Manage Trips ..... 7-3
  - Hexadecimal Representation of Trips ..... 7-7
  - Fault Finding..... 7-10
- Chapter 8: Routine Maintenance and Repair..... 8-1**
  - Routine Maintenance..... 8-2
  - Repair ..... 8-2
    - Saving Your Application Data ..... 8-2
    - Returning the Unit to Parker SSD Drives..... 8-2
    - Disposal ..... 8-3
- Chapter 9: Technical Specifications ..... 9-1**
  - Understanding the Product Code ..... 9-2
  - Environmental Details ..... 9-3
  - Power Details ..... 9-4
  - Electrical Ratings ..... 9-5
  - User Relay ..... 9-7
  - Analog Inputs/Outputs..... 9-7
  - Digital Inputs..... 9-8
  - Digital Outputs..... 9-8



Cabling Requirements for EMC Compliance.....	9-9
Internal Dynamic Braking Circuit .....	9-10
External Brake Resistor.....	9-11
Supply Harmonic Analysis (230V filtered) .....	9-13
Supply Harmonic Analysis (400V filtered) .....	9-14
Supply Harmonic Analysis (230V unfiltered) .....	9-15
Supply Harmonic Analysis (400V unfiltered) .....	9-16
<b>Chapter 10: Certification for the Drive .....</b>	<b>10-1</b>
Requirements for EMC Compliance .....	10-2
Earthing Requirements .....	10-2
Requirements for UL Compliance .....	10-3
European Directives and the CE Mark.....	10-6
CE Marking for Low Voltage Directive .....	10-6
CE Marking for EMC - Who is Responsible? .....	10-6
EMC Compliance.....	10-7
Certificates .....	10-8
<b>Chapter 11: Serial Communications.....</b>	<b>11-1</b>
Connection to the P3 Port .....	11-2
<b>Chapter 12: Applications .....</b>	<b>12-1</b>
The Default Application .....	12-2
How to Load an Application.....	12-2
Application Description.....	12-3

# **Chapter 1: Getting Started**

## Introduction to the 650S Series AC Drive

<b>Introduction .....</b>	<b>1-2</b>
Equipment Inspection	1-3
Storage and Packaging	1-3
<b>About this Manual .....</b>	<b>1-3</b>

# Introduction

The 650S Series AC Drive provides simple, compact, and low-cost sensorless speed control for 3-phase PMAC motors with sinusoidal Back EMF.

This manual describes the low-power end of the 650S product range for the following motor power ratings:

	Nominal Input Voltage	Phase	Drive Power	
<b>Frame 1</b>	230V	1	0.25 – 0.75kW	0.3 - 1.0 Hp
<b>Frame 2</b>	230V	1	1.1 – 1.5kW	1.5 - 2.0 Hp
<b>Frame 2</b>	400V	3	0.37 – 2.2kW	0.5 - 3.0 Hp
<b>Frame 3</b>	400V	3	3.0 – 7.5kW	4.0 - 10.0 Hp

The drive features:

- Local or Remote mode operation
- SELV control terminals (Safe Extra Low Volts)
- Intelligent monitoring strategy to avoid nuisance tripping
- In-built protection of the unit against overloads, excessive voltages, phase-to-phase and phase-to-earth short circuits
- An internal RFI filter is fitted as standard
- An internal dynamic brake switch for connection to an external resistor (400V units only)
- Quiet operation
- Controlling the unit locally using the 6511 Keypad gives access to parameters, diagnostic messages, trip settings and full application programming.

**Note:** Do not attempt to control motors whose rated current is less than 50% of the drive rated current. Poor motor control may occur if you do.

## Equipment Inspection

- Check for signs of transit damage
- Check the drive is suitable for your requirements by reading the Product Code on the rating label. Refer to Chapter 9: “Technical Specifications” - Understanding the Product Code.

If the unit is damaged, refer to Chapter 8: “Routine Maintenance and Repair” for information on returning damaged goods.

## Storage and Packaging

Save the packaging in case of return. Improper packaging can result in transit damage.

If the unit is not being installed immediately, store the unit in a well-ventilated place away from high temperatures, humidity, dust or metal particles.

# About this Manual

---

This manual is intended for use by the installer, user and programmer of the drive. It assumes a reasonable level of understanding in these three disciplines.

**Note:** Please read all Safety Information before proceeding with the installation and operation of this unit.

It is important that you pass the manual on to any new user of this unit.

## Software Product Manual

An accompanying Software Product Manual is available for download from the Parker SSD Drives website: [www.SSDdrives.com](http://www.SSDdrives.com).

## 1-4 *Getting Started:*

## **Chapter 2:** **Product Overview**

An overview of the 650S AC Drive

Component Identification..... 2-2

# Component Identification

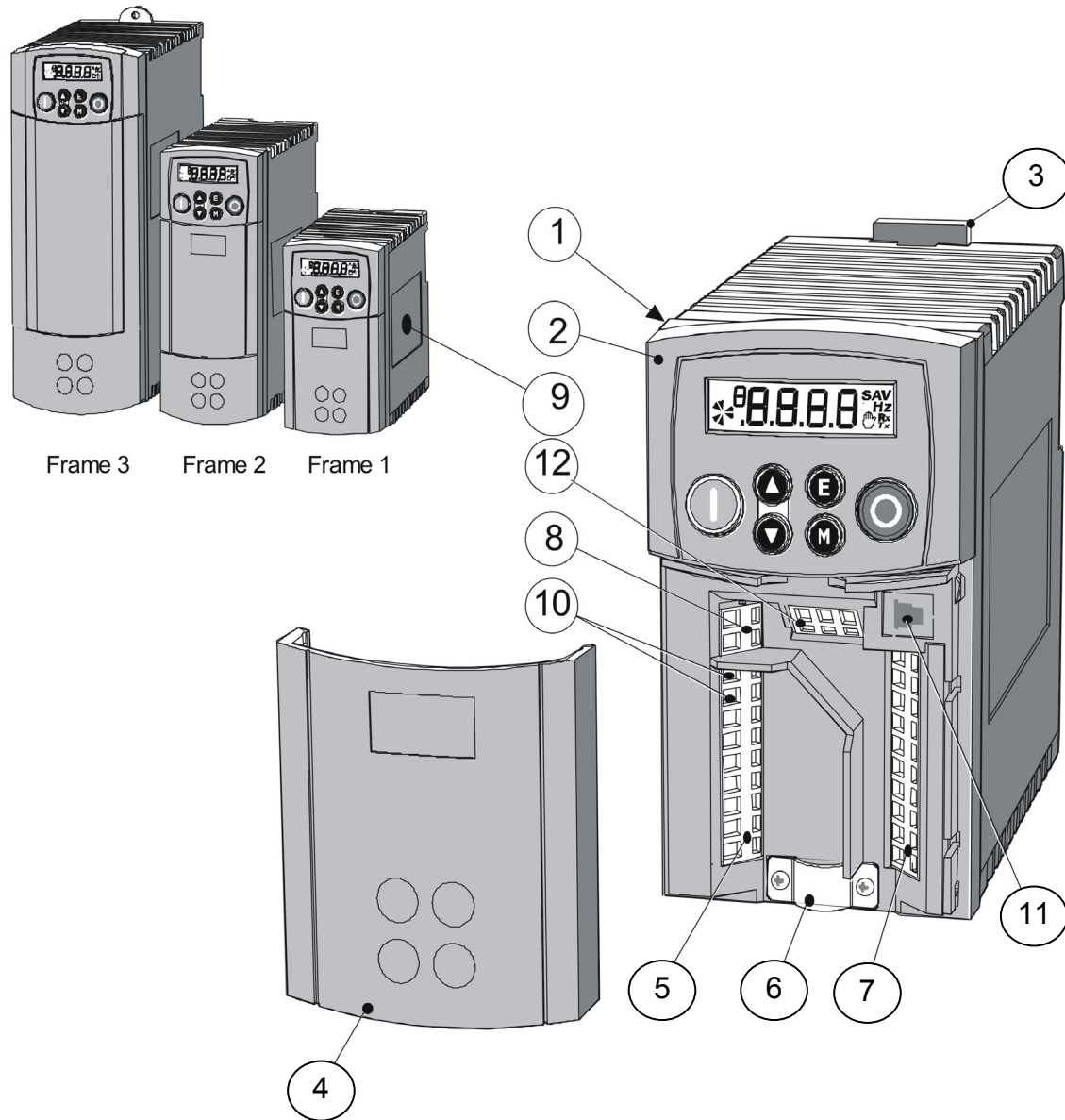

- 1 Main drive assembly
- 2 Keypad
- 3 DIN clip/fixing bracket
- 4 Terminal cover
- 5 Power terminals
- 6 Motor cable screen clamp
- 7 Control terminals
- 8 Volt-free relay contacts
- 9 Product rating label
- 10 Motor thermistor terminals
- 11 RS232 programming port - P3
- 12 Encoder/digital inputs

Frame 1 Illustrated

## Chapter 3: **Installing the Drive**

How to install your drive.

<b>Mechanical Installation .....</b>	<b>3-2</b>
Mounting the Drive	3-3
Ventilation	3-3
<b>Electrical Installation .....</b>	<b>3-4</b>
Wiring Instructions	3-4
<b>Optional Equipment .....</b>	<b>3-11</b>



# Installing the Drive

**IMPORTANT:** *Read Chapter 10: “Certification for the Drive” before installing this unit.*

## Mechanical Installation

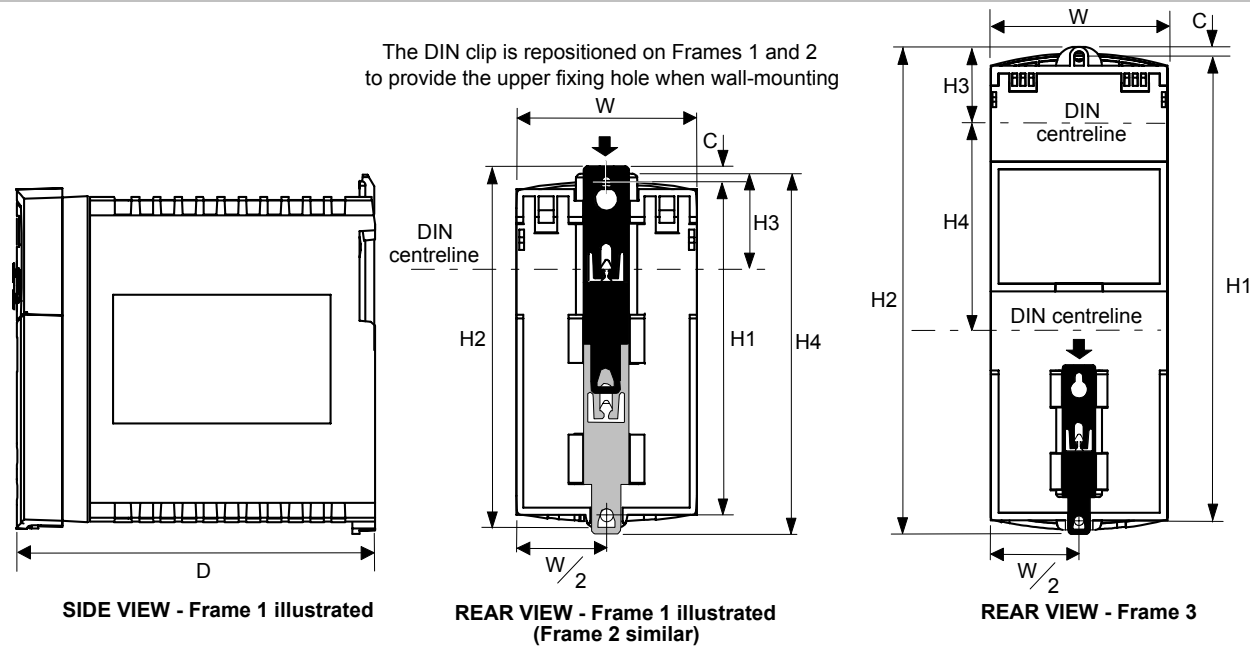

	Fixing	Torque	Weight	H1 Fixing Centres	H2	H3	H4	C	W	D
<b>Frame 1</b>	M4	1.5Nm	0.85kg(2 lbs)	132(5.2")	143(5.6")	35(1.4")	139(5.5")	6(0.2")	73(2.9")	142(5.6")
<b>Frame 2</b>	M5	3.0Nm	1.4kg(3 lbs)	188(7.4")	201(7.9")	35(1.4")	194(7.7")	6.5(0.24")	73(2.9")	173(6.8")
<b>Frame 3</b>	M5	3.0Nm	2.7kg(6 lbs)	242(9.5")	260(10.2")	38(1.5")	112(4.4")	5(0.2")	96(3.8")	200(7.9")

Dimensions are in millimetres ( inches )

## Mounting the Drive

To maintain compliance with European Electrical Safety Standard VDE0160/EN50178 the unit must be mounted inside a control cubicle that requires a tool for opening. The cubicle should provide 15dB attenuation to radiated emissions between 30-100MHz.

**Mount the drive vertically** on a solid, flat, non-flammable, vertical surface. It can be panel-mounted, or rail-mounted on a rail complying with EN50022 (35mm DIN).

### DIN Mounting

To DIN mount the unit, hang the unit on the top DIN rail and push the unit onto the bottom DIN rail until it snaps in to position. Secure with a lower screw fixing. To release the unit, use a flat bladed screwdriver as shown.

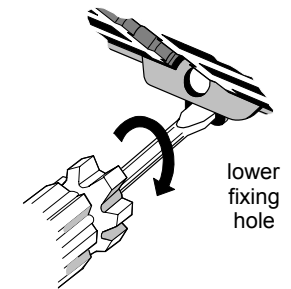

## Ventilation

Maintain a minimum air clearance for ventilation of 100mm (4 inches) above and below the unit. When mounting two or more 650S units together, these clearances are additive. Ensure that the mounting surface is normally cool. Be aware that adjacent equipment may generate heat and also have clearance requirements. Provided the minimum clearance for ventilation is maintained, 650S drives may be mounted side-by-side.

# Electrical Installation

**IMPORTANT:** *Read the Safety Information on page Cont. 2 before proceeding.*

## Wiring Instructions

### Local Control Wiring

This is the simplest installation. Every new drive will operate in Local Control when first powered-up. The keypad is used to start and stop the drive.

Refer to the Connection Diagram and install the:

- Thermistor cable, or link/jumper terminals TH1A and TH1B (we recommend you do use a thermistor)
- Motor cable
- Supply cable
- Follow the earthing/grounding and screening advice

Refer to Chapter 4: "Operating the Drive"- Local Control Operation.

*Minimum Connections*

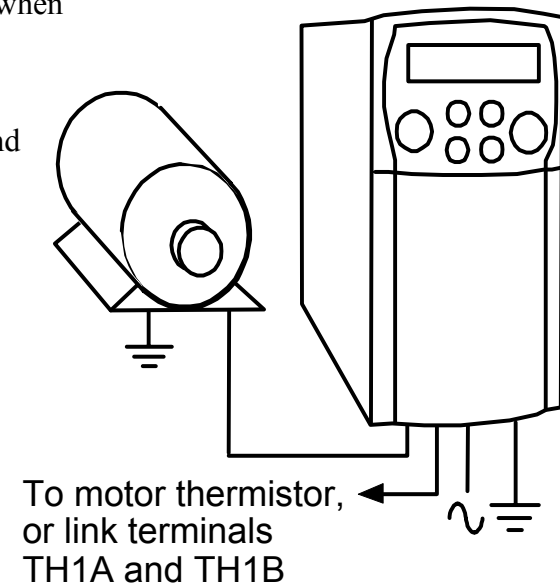

# Remote Control Wiring

If operating in Remote Control you will use your control panel to start and stop the drive, via a speed potentiometer and switches or push-buttons.

The diagram below shows the **minimum** connections to operate the drive for single-wire (switch) starting, and push-button starting.

Referring to the Connection Diagram:

- Follow the instructions for Local Control Wiring, as detailed previous
- Install using minimum connections

## Minimum Connections for Application 1:

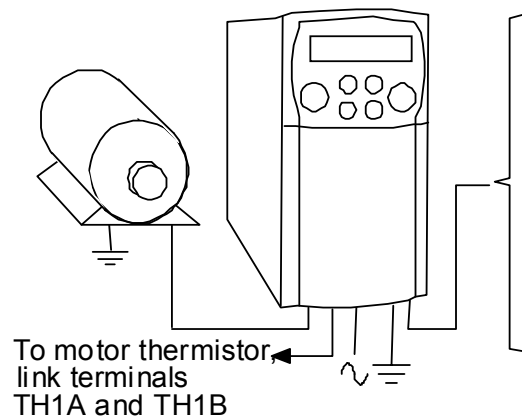

## Single Wire Starting

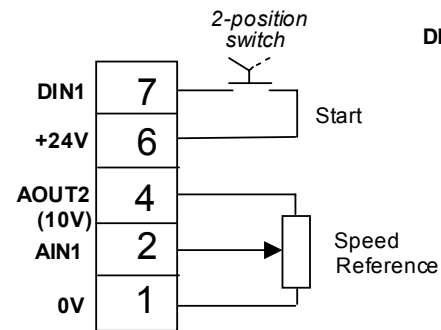

## Push-Button Starting

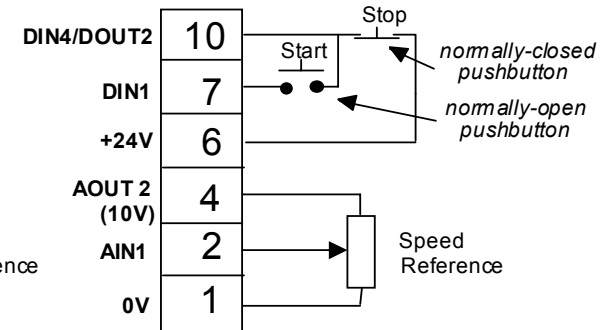

**Note:** You can still operate the drive in Local mode, if necessary, with any Application selected.

Refer to Chapter 4: "Operating the Drive" and follow the relevant instructions for Single Wire Starting or Push-Button Starting.

### WARNING!

This product is designated as "professional equipment" as defined in EN61000-3-2. Where enforced, permission of the supply authority shall be obtained before connection to the low voltage domestic supply.

Ensure that all wiring is electrically isolated and cannot be made "live" unintentionally by other personnel. The drive is suitable for use with both earth referenced supplies (TN) and non-earth referenced supplied (IT) when fitted with an internal ac supply EMC filter.

# Connection Diagram

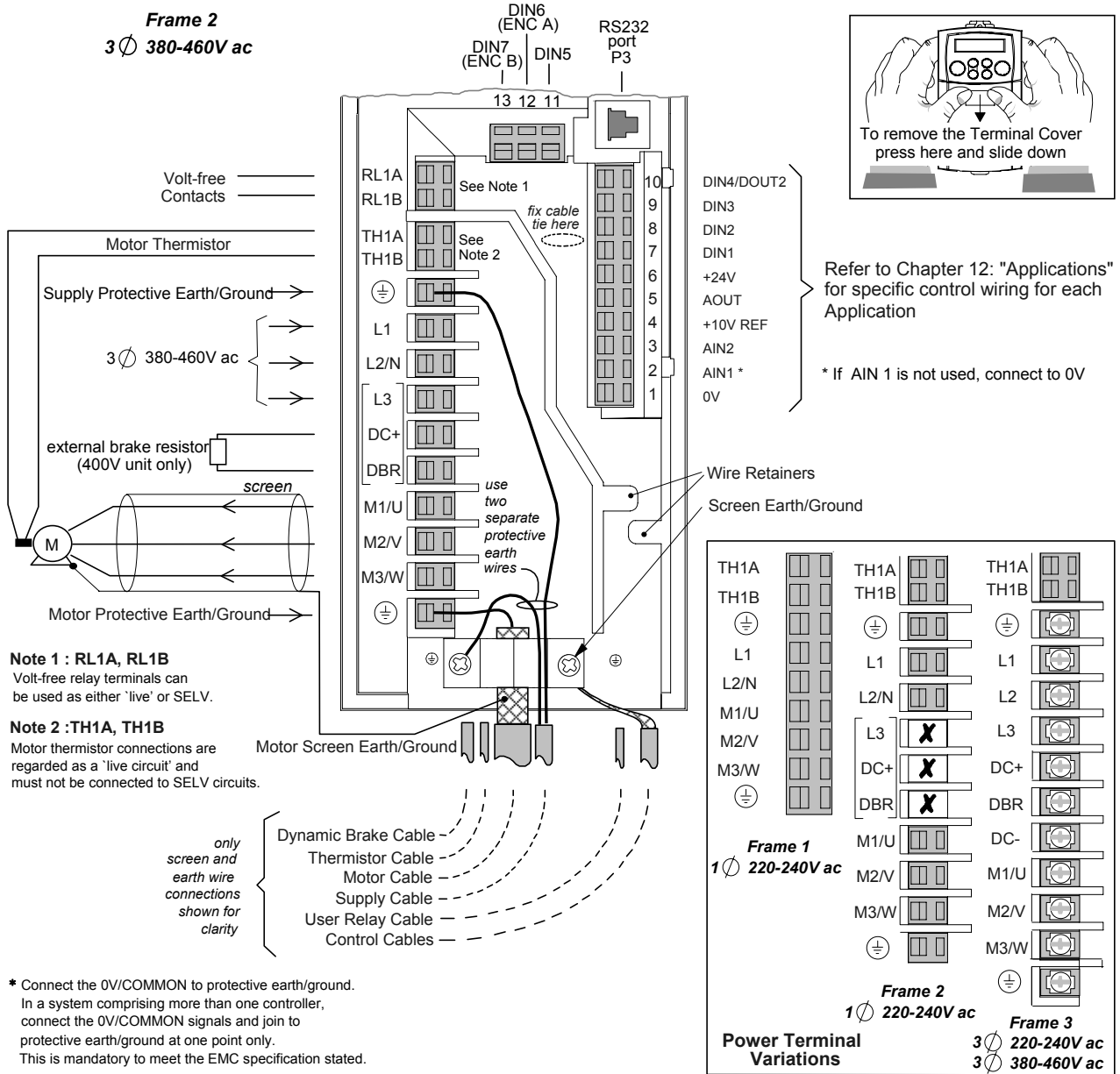

\* Connect the 0V/Common to protective earth/ground. In a system comprising more than one controller, connect the 0V/Common signals and join to protective earth/ground at one point only. This is mandatory to meet the EMC specification stated.

## Wiring Instructions

- 1 Remove the terminal cover from the drive.
- 2 Loosen the motor cable screen clamp.
- 3 Connect the power supply cable, motor cable and control cables (if required).
- 4 Fasten the motor cable in place with the motor cable screen clamp. Secure any control cable screen connections under the right hand screw.  
*Frames 2 & 3 only : Secure control cables under the wire retainers.*
- 5 Connect the thermistor and user-relay if required.  
*Frames 2 & 3 only: connect the dynamic brake if required (400V units only).*
- 6 Use a cable tie and secure all the control cables and user-relay cables (if fitted) as close to the control terminals as possible.
- 7 Connect the ancillary equipment as shown, for example, an external brake resistor.
- 8 Re-fit the terminal cover.

## IMPORTANT:

Note that the 650S unit must be **permanently earthed** using two independent protective earth/ground incoming supply conductors.

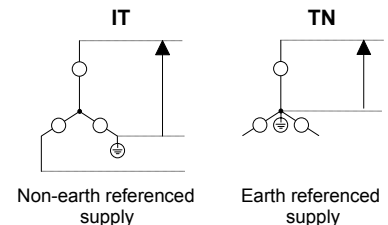



The drive is suitable for use with earth referenced supplies (TN) and non-earth referenced supplies (IT) when fitted with an internal ac supply EMC filter.

## Control Wiring Connections

Terminal (SELV)	Name	Application 1 Default Function (for other Applications refer to Chapter 12: "Applications")	Range
P3	P3	RS232 port for use with remote-mounted RS232 keypad or programming PC	-
RL1A	User Relay	Volt-free contact	0-250Vac/24Vdc 4A
RL1B	User Relay	Volt-free contact	0-250Vac/24Vdc 4A
13	DIN7 (ENC B)	Configurable digital input/encoder input	0-24V
12	DIN6 (ENC A)	Configurable digital input/ encoder input	0-24V
11	DIN5	<b>Not Coast Stop</b> - configurable digital input: 0V = Stop, 24V = Coast Stop	0-24V
10	DIN4/ DOUT2	Configurable digital input/output <b>Not Stop</b> (input): 0V = No latching of Run (DIN1), 24V = Run latched	0-24V Current sourcing *
9	DIN3/DOUT1	Configurable digital input/output <b>Jog</b> – configurable digital input: 0V = Stop, 24V = Jog	0-24V
8	DIN2	<b>Direction</b> – configurable digital input: 0V = Forward, 24V = Reverse	0-24V
7	DIN1	<b>Run Forward</b> – configurable digital input: 0V=Stop, 24V=Run	0-24V
6	+24V	24V supply for digital I/O	24V *
5	AOUT1	<b>Ramp Output</b> – configurable analog output (10mA loading)	0-10V
4	AOUT2	<b>10V reference</b> configurable analog output (10mA maximum loading)	0-10V
3	AIN2	<b>Speed Trim</b> – analog input 2	0-10V, 4-20mA
2	AIN1	<b>Speed Setpoint</b> – analog input 1. If AIN 1 is not used, connect to 0V.	0-10V
1	0V	0V reference for analog/digital I/O	0V

\* The total current available is 50mA, either individually or as the sum of terminal 6 & 10.

## Power Wiring Connections

Terminal	Description	Function	Range	
			200V 1-Phase	200V/400V 3-Phase
TH1A	Thermistor	Connection to motor thermistor	It is good practice to protect motors by fitting temperature sensitive resistors. A typical resistance (up to a reference temperature of 125°C) is 200Ω, rising rapidly to 2000Ω above this temperature. Connect devices in series between TH1A and TH1B. Link the terminals if temperature sensors are not used.	
TH1B	Thermistor	Connection to motor thermistor		
	Reference Terminal	Supply protective earth (PE). This terminal must be connected to a protective (earth) ground for <b>permanent earthing</b> .		
L1 *	Power Input	Single and three phase live connection	220/240V ac ±10% rms with respect to L2/N. 50-60Hz (IT/TN)	220/240V or 380/460V ac ±10% rms with respect to L2, L3 phase-to-phase. 50-60Hz (IT/TN)
L2/N * L2	Power Input	Single phase neutral (or L2 three phase live connection)	220/240V ac ±10% with respect to L1. 50-60Hz (IT/TN)	220/240V or 380/460V ac ±10% with respect to L1, L3. 50-60Hz (IT/TN)
L3	Power Input	Three phase live connection	Not applicable	220/240V or 380/460V ac ±10% with respect to L1, L2. 50-60Hz (IT/TN)
DC-	<i>No user connection</i>			
DC+	Dynamic Brake	Connection to external brake resistor	Not applicable	Frame 2 (high volt only) & 3. See "Internal Dynamic Brake Switch" table
DBR	Dynamic Brake	Connection to external brake resistor	Not applicable	Frame 2 (high volt only) & 3. See "Internal Dynamic Brake Switch" table
M1/U M2/V M3/W	Motor Outputs	Connection for motor	Motor rated at: 0 to 220/240V ac 0 to 500Hz	Motor rated at: 0 to 220/240V or 0 to 380/460V ac 0 to 500Hz
	Reference Terminal	Supply protective earth (PE). This terminal must be connected to a protective(earth) ground for <b>permanent earthing</b> .		

## Terminal Block Acceptance Sizes

Wire sizes should be chosen with respect to the operating conditions and your local National Electrical Safety Installation Requirements. Local wiring regulations always take precedence.

Frame Size	Power Terminals (maximum wire size)	Brake Terminals (maximum wire size)	Thermistor/Control Terminals (maximum wire size)
Frame 1 230V	2.5mm <sup>2</sup> /12 AWG	Not Applicable	2.5mm <sup>2</sup> /12 AWG
Frame 2 230V	2.5mm <sup>2</sup> /12 AWG	Not Applicable	2.5mm <sup>2</sup> /12 AWG
Frame 2 400V	2.5mm <sup>2</sup> /12 AWG	2.5mm <sup>2</sup> /12 AWG	2.5mm <sup>2</sup> /12 AWG
Frame 3 230V	6.0mm <sup>2</sup> /10 AWG	6.0mm <sup>2</sup> /10 AWG	2.5mm <sup>2</sup> /12 AWG
Frame 3 400V	6.0mm <sup>2</sup> /10 AWG	6.0mm <sup>2</sup> /10 AWG	2.5mm <sup>2</sup> /12 AWG

## Power Wiring

**Note:** For specified EMC emission and immunity performance, install to EMC Installation Instructions. Refer to Chapter 10: “Certification for the Drive” - for more information

Terminal tightening torque for Frame 3 power connections is 20 lb.in (2.26Nm).

Protect the incoming mains supply using the specified fuse, or RCD circuit breaker Type B.

**IMPORTANT:** *We do not recommend the use of circuit breakers (e.g. RCD, ELCB, GFCI), however, where their use is mandatory, they must:*

- Operate correctly with dc and ac protective earth currents (i.e. type B RCDs as in Amendment 2 of IEC755).
- Have adjustable trip amplitude and time characteristics to prevent nuisance tripping on switch-on.



## 3-10 *Installing the Drive:*

### **Control Wiring**

Control wiring of between 0.08mm<sup>2</sup> (28AWG) and 2.5mm<sup>2</sup> (12AWG) can be used. Ensure all wiring is rated for the highest system voltage. All control terminals are SELV, i.e. double-insulated from power circuits.

### **Using Cage Clamp Terminals**

Strip wire insulation to 5-6mm (0.20-0.24 inches), or alternatively use wire-crimps. Use a flat-bladed screwdriver, maximum blade size 3.5mm. The cage provides the correct force for a secure connection.

**IMPORTANT:** *DO NOT lever or turn the screwdriver.*

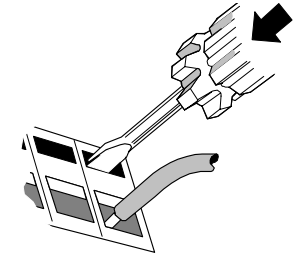

# Optional Equipment

## Fitting the Remote 6511 Keypad

You can remote-mount the drive-mounted Keypad using:

- the RS232 (P3) port located under the terminal cover
- A standard P3 lead, SSD Part Number CM057375U300, which is used to connect the Keypad to the drive.

Two self-tapping screws are provided with the Keypad. Remove the protective film from the gasket. An enclosure rating of IP20 is achieved for the remote Keypad when correctly mounted.

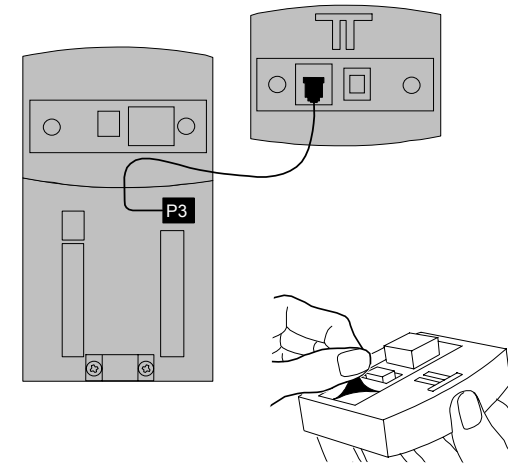

## Assembly Procedure

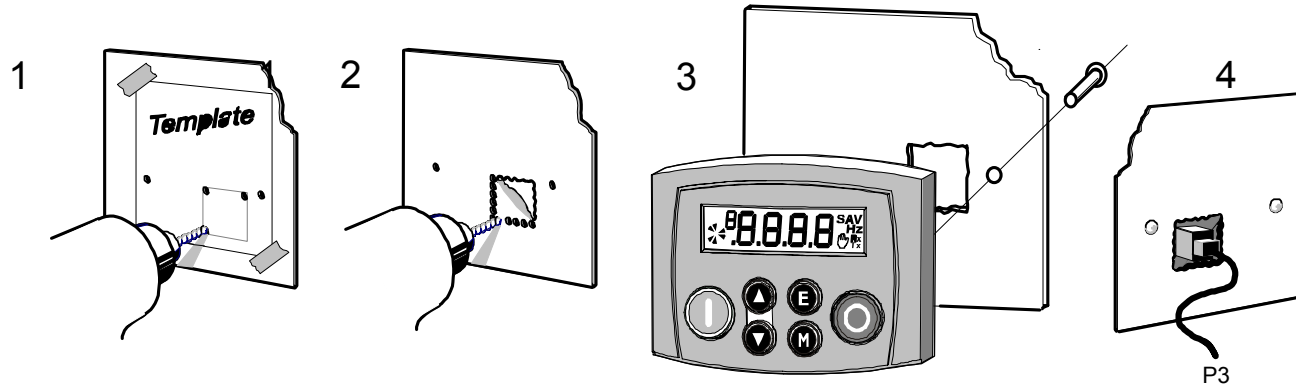

## 3-12 *Installing the Drive:*

### **Cut-out Dimensions**

The drawing below can be photocopied actual size (100%) and used as a template.

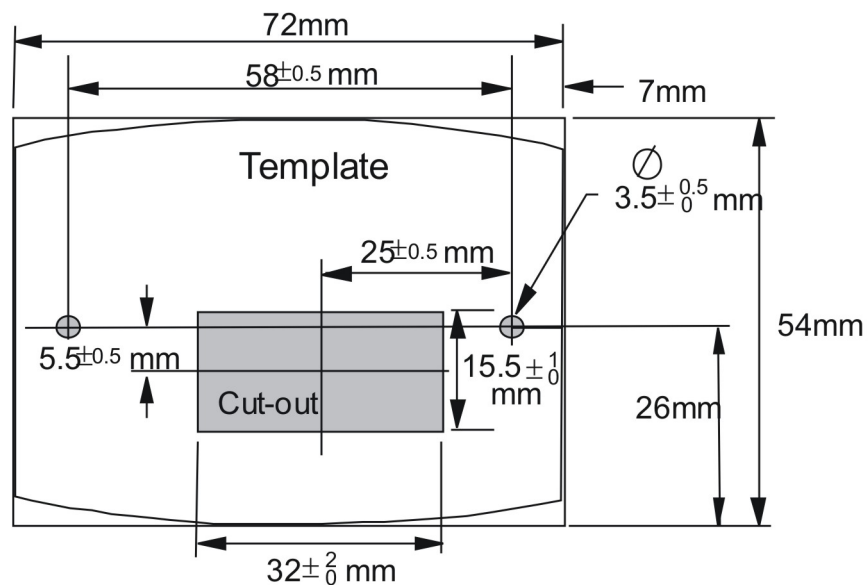

### **Additional Remote Keypad Options:**

650S is also compatible with 6521/6901/6911 Opstations which all require a 6052 Mounting Kit, if door marked (IP20). The assembly procedure is supplied with the mounting kit.

# RS485/RS232 Communication Module

You can create a network of drives by linking a Master (PC/PLC) to one or more 650S drives fitted with this module.

Plug this Communication Module on to the front of the 650S drive, replacing the keypad.

It converts signals from the host 650S drive into RS485 or RS232, and vice versa, so that information can be shared between the Master and 650S drive(s).

Wiring is very simple - all connections are SELV (Safe Extra Low Voltage). Select to use RS485 or RS232 by wiring to the appropriate terminal on the module.

**Note:** RS485 and RS232 terminals cannot be used simultaneously.

We recommend you ground the module to the system earth using the Functional Earth terminal.

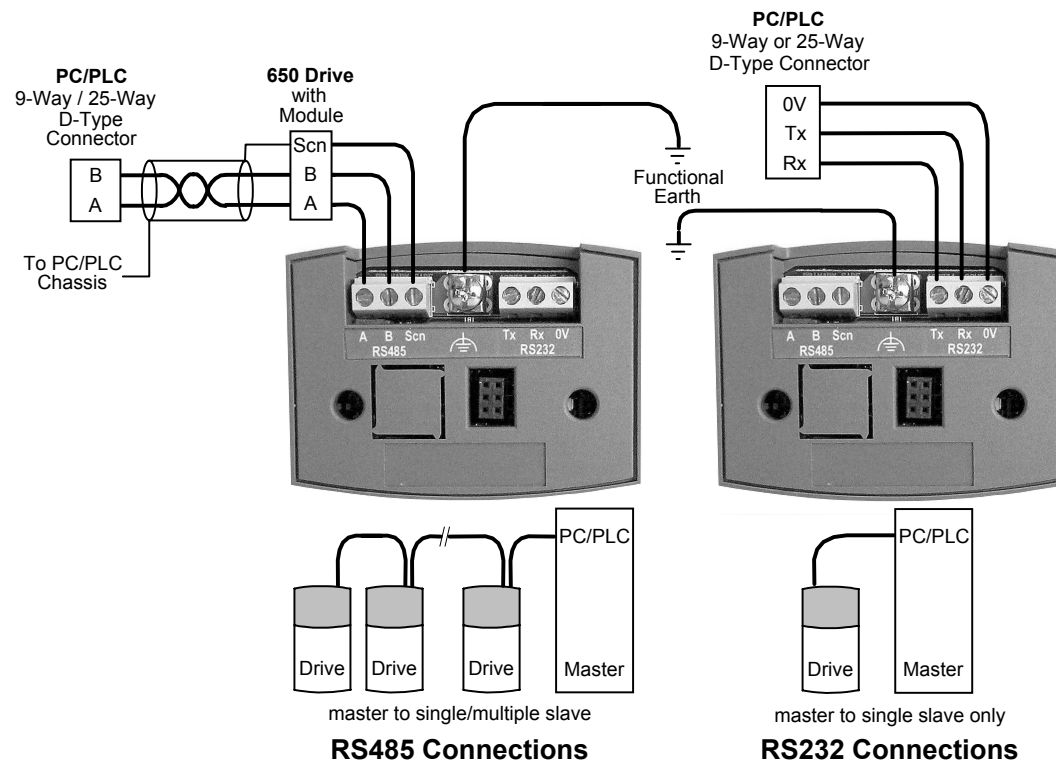

### 3-14 *Installing the Drive:*





<b>Wiring Specifications</b>		
	<b>RS485 Connections</b>	<b>RS232 Connections</b>
<b>Network Type</b>	2-Wire Shielded Twisted-Pair	3-Wire Un-Shielded Cable
<b>Connections</b>	A=RxA/TxA, B=RxB/TxB, Shield	Rx, Tx, Ground (0V)
<b>Signal Levels</b>	To RS485 Standard	To RS232 Standard
<b>Receiver Input Impedance</b>	¼ Unit Load	3 kΩ minimum 7kΩ maximum
<b>Maximum Cable Length</b>	1200m (4000ft)	3 metres
<b>Maximum Baud Rate</b>	57.6kbaud	57.6kbaud
<b>Maximum Number of Units</b>	32 including slaves and masters	2: 1 master and 1 slave only

## LED Indications

The module has three LEDs providing diagnostic information about the 650S host drive's 'Health', 'Receive' and 'Transmit' activity.

HEALTH = Green, Rx = Red, Tx =Red



LED Name	LED Duty	Drive State
HEALTH	 SHORT FLASH	Re-configuration, or corrupted non-volatile memory at power-up
	 EQUAL FLASH	Tripped
	 ON	Healthy
	 LONG FLASH	Braking
	 OFF	No drive power, or serious hardware fault
Rx	INTERMITTENT	Indicates activity on the 'receive' line carrying data from the Master
Tx	INTERMITTENT	Indicates activity on the 'transmit' line carrying data to the Master

## Configure the Drive

Before the module can be used you must configure the drive to your system. Set-up the parameters in the SERIAL menu as appropriate. Refer to Chapter 6: "Programming Your Application" - SET::SERL Menu, parameters <sup>S</sup>SE01 to <sup>S</sup>SE08.

For Tag number information refer to the 650S Software Product Manual, available on the Parker SSD Drives website: [www.SSDdrives.com](http://www.SSDdrives.com).

## Encoder Connections

The drive is **only** suitable for use with single-ended encoders. Take special care wiring the encoder to the drive due to the low level of the signals.

All wiring to the drive should be made in screened cable. Use cable with an overall screen and a over each individual pair. To ensure compliance with the EMC Directive the overall cable screen be connected to the drive chassis.

*Recommended cable (pairs individually screened):*

Belden equivalent 8777

Parker SSD Drives Part Number CM052666

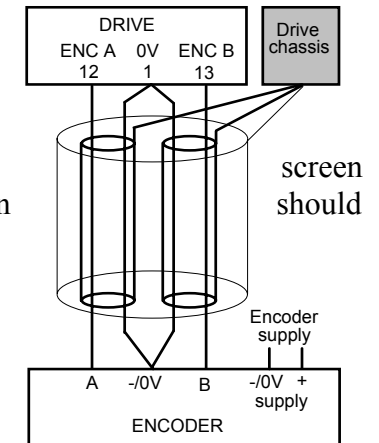

The drive will operate with 5-24V encoders. Provide the correct supply for the encoder. Do not use the 10V or 24V supply from the drive.

The maximum input frequency of terminals 12 and 13 (ENCA and ENCB) is 100kHz.

## **Chapter 4:** **Operating the Drive**

Having turned the motor for the first time, now learn about the various ways you can start and stop the drive. This chapter also offers some application advice.

<b>Pre-Operation Checks .....</b>	<b>4-2</b>
<b>Initial Start-up Routines .....</b>	<b>4-3</b>
Local Control Operation	4-4
Remote Control Operation	4-5
Set-up	4-6
<b>Tuning the Drive to Your System .....</b>	<b>4-7</b>



# Pre-Operation Checks

## **WARNING!**

Wait for 5 minutes after disconnecting power before working on any part of the system or removing the terminal cover from the drive.

### **Initial checks before applying power:**

- Check for damage to equipment.
- Mains power supply voltage is correct.
- Motor is of correct voltage rating
- Check all external wiring circuits - power, control, motor and earth connections.

*Note:* **Completely disconnect the drive before point to point checking with a buzzer, or when checking insulation with a Meggar.**

- Check for loose ends, clippings, drilling swarf etc. lodged in the drive and system.
- If possible check that the motor can be turned freely, and that any cooling fans are intact and free from obstruction.

### **Ensure the safety of the complete system before the drive is energised:**

- Ensure that rotation of the motor in either direction will not cause damage.
- Ensure that nobody else is working on another part of the system which will be affected by powering up.
- Ensure that other equipment will not be adversely affected by powering up.

### **Prepare to energise the drive and system as follows:**

- Remove the supply fuses, or isolate using the supply circuit breaker.
- Disconnect the load from the motor shaft, if possible.
- If any of the drives control terminals are not being used, check whether these unused terminals need to be tied high or low.
- If the motor thermistor terminals are not connected to a motor thermistor, connect these terminals together.
- Check external run contacts are open. Check external speed setpoints are all zero.

### **Re-apply power to the drive and system**

# Initial Start-up Routines

**Note:** Refer to Chapter 5: “The Keypad” to familiarise yourself with the keypad’s indications, and how to use the keys and menu structure.



## IMPORTANT

When power is applied to the drive in Remote Control, it will immediately start running if the RUN signal is active.

## WARNING!

Unpredictable motion, especially if motor parameters are incorrect.  
 Ensure no personnel are in the vicinity of the motor or any connected machinery.  
 Ensure that machinery connected to the motor will not be damaged by unpredictable motion.  
 Ensure that the emergency stop circuits function correctly before running the motor for the first time.

The drive can be started in either Remote Control or Local Control. **By default, the drive will start in Local Control.**

These routines assume that the drive’s control terminals are wired as shown in the Control Wiring Connections in Chapter 3.

Connected in this way, a positive setpoint will rotate the motor in a clockwise direction when viewed down the shaft, looking toward the motor.

**If during the start-up routine the display shows either an alarm (indicated by the letter “A”) or a flashing Warning message, refer to Chapter 7: “Trips and Fault Finding”.**

A typical alarm

# Local Control Operation

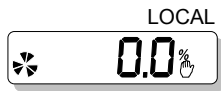

This is the simplest method of operating the drive. Connect the keypad to the drive and power-up the unit. The drive will display the Local screen. If not, refer to Chapter 5 and select Local Control.

Follow the instructions opposite to start and stop the motor.

**Reverse:** Instead of setting a negative setpoint, you can reverse the motor direction by pressing STOP + ▼, or START + ▼.

To change the direction to forwards, (the normal direction), press STOP + ▲ or START + ▲.

Note that the Setpoint parameter will not change sign to indicate this change, however the rotating indicator on the MMI will show the direction.

We recommend that you use the STOP key commands if the motor is stopped, and the START key commands if the motor is running. The keys should be pressed and released together.

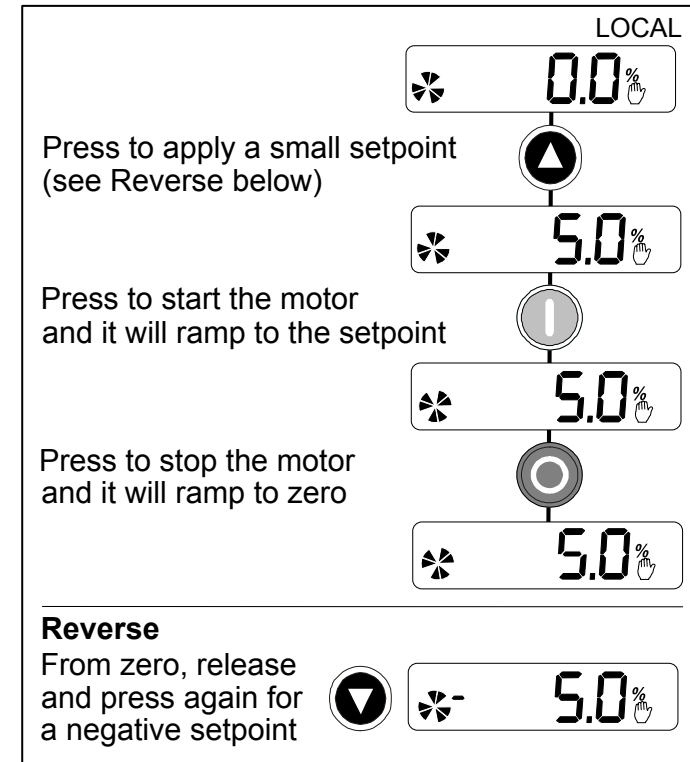

# Remote Control Operation

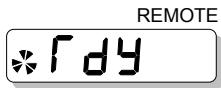

Connect the keypad to the drive and power-up the unit.

The drive will display the Local screen. Refer to Chapter 5 and select Remote Control.

**IMPORTANT:** *Ensure that the speed potentiometer is set to zero.*

Follow the instructions below to start and stop the motor using your control panel.

Reverse the motor's direction of rotation using the DIN2 connection (0V = forward, +24V = reverse). Alternatively, swap two of the motor phases  
**(WARNING: Disconnect the mains supply first).**

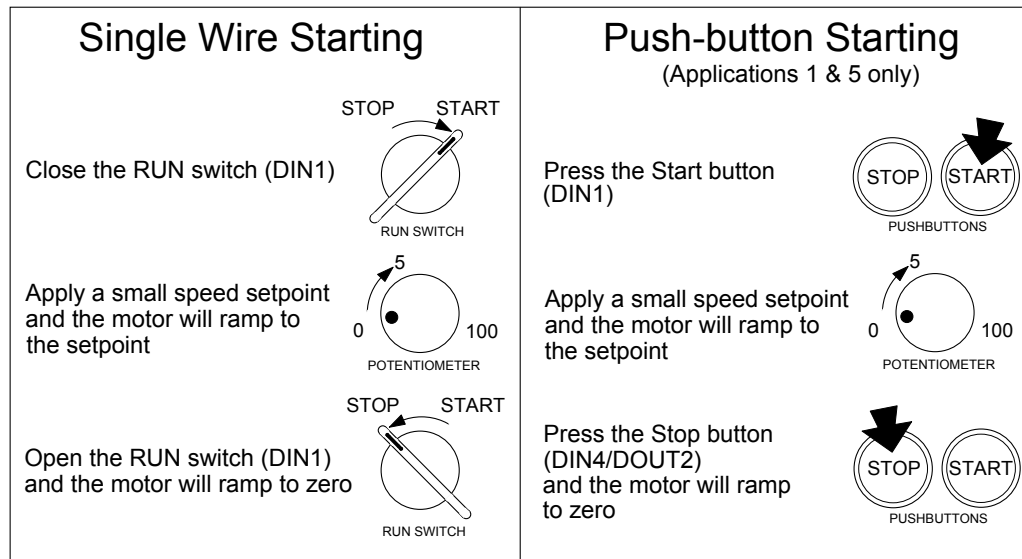

## ***The installation of your drive is now complete:***

The drive will operate as a sensorless drive. It is programmed to control a PMAC motor of equivalent power, current, and voltage rating to the drive. Using the keypad (or other suitable programming tool) the drive must now be set-up.

## Set-up

The drive is operating in Sensorless Permanent Magnet AC (PMAc) Mode

The drive needs to know more about your system. You **MUST** enter "actual" values from your motor nameplate for the parameters listed below. These parameters are in the SET::PAC1 Menu. See Section 6.

Display	Parameter	Default	Brief Description
SPA01	MAX SPEED	3200RPM	Set the maximum motor speed.
SPA02	MAX CURRENT	5.65A	Set the motor maximum current in Amps rms.
SPA03	PERM CURRENT	2.43A	Set the motor nominal current in Amps rms.
SPA04	PERM TORQUE	2.0Nm	Set the motor nominal torque in Nm.
SPA05	POLES	10	Set the motor number of poles.
SPA06	BACK EMF	50.9V	Set the motor's Back EMF phase to phase, rms value (in Volts/1000RPM)
SPA07	R	6.58Ohms	Set the motor's resistance, between phase at 25°C.
SPA08	L	20.3mH	Set the motor's inductance, between phase at nominal current.
SPA09	KT	0.848NM/A	Set the motor's torque constant in Nm/Amps rms
SPA10	INERTIA	0.070	Set the motor's inertia. The units for this parameter are set by the INERTIA SCALE parameter.
SPA11	INERTIA SCALE	0	Set the motor's inertia scale: 0 = gm <sup>2</sup> 1 = kgcm <sup>2</sup> 2 = kgm <sup>2</sup>
SPA12	THERMAL TIME CST	62s	This parameter is used for the motor protection, e.g. I2T motor load. It defines the thermal time constant of the motor that is used to protect the motor1 against overheating. Refer to the PMAc MOT PROTECT for a definition.
SPA13	CUR LOOP BWDTH	400Hz	Set the current loop bandwidth in Hz. This value will automatically generate the proportional gain of the PI corrector of the current loop. The proportional gain is calculated based on the 'L' motor 2 parameter. Modifying this value could induce instability. Please contact Parker SSD Drives if you need to change it.
SPA14	INTEGRAL FREQ	100Hz	Set the frequency of the I term of the PI current loop corrector. The ratio CUR LOOP BWDTH/INTEGRAL FREQ must be kept higher than 3. Modifying this value could induce instability. Please contact Parker SSD Drives if you need to change it.

You also needs to set up the speed loop parameters, mainly the parameters below, see the SET::CTRL Menu see Section 6 :

Display	Parameter	Default	Brief Description
5CL91	SPEED PROP GAIN	Default is Product Code dependent	Sets the proportional gain of the loop. Speed error (revolutions per second) x proportional gain = torque percent.
5CL92	SPEED INT TIME	Default is Product Code dependent	This is the integral time constant of the speed loop. A speed error which causes the proportional term to produce a torque demand T, will cause the integral term to also ramp up to a torque demand T after a time equal to "speed int time".

# Tuning the Drive to Your System

Finally, adjust the parameters below as necessary to tune the drive to your system. Refer to Chapter 6: "Programming Your Application" for details.

Display	Parameter	Default	Brief Description
P 2	MAX SPEED	Default is Product Code dependent	Set the speed in Hz at which the 650S will run when the maximum setpoint is applied.
P 3	MIN SPEED	0.0%	Set the minimum frequency at which the 650S will run, as a % of MAX SPEED
P 4	ACCEL TIME	10.0 s	Set the time taken for the 650S to ramp up from zero to MAX SPEED
P 5	DECEL TIME	10.0 s	Set the time taken for the 650S to ramp down from MAX SPEED to zero
P 8	JOG SETPOINT	10.0 %	Set the jogging speed setpoint, as a % of MAX SPEED
P 9	RUN STOP MODE	0	Select the method by which the motor speed is reduced to zero

## 4-8 *Operating the Drive:*

## Chapter 5: **The Keypad**

In this chapter, learn about the control keys and keypad indications.

<b>The 6511 Keypad .....</b>	<b>5-2</b>
<b>Controlling the Drive using the Keypad .....</b>	<b>5-3</b>
Control Key Definitions	5-3
Display Indications	5-4
Drive Status Indications	5-5
The DIAGNOSTICS Menu	5-6
<b>The Menu System .....</b>	<b>5-7</b>
How To Change a Parameter Value	5-8
<b>Special Menu Features.....</b>	<b>5-9</b>
Resetting to Factory Defaults (2-button reset)	5-9
Changing the Drive Operating Frequency	5-9
Selecting Local or Remote Control	5-10
Password Protection	5-11
Selecting the Menu Detail	5-12



# The 6511 Keypad

The 6511 Keypad (Man-Machine Interface, MMI) provides for local control of the drive, monitoring, and complete access for application programming.

The 650S can be fitted with either a Standard or Remote Keypad. Both Keypads fit on the front of the drive, but the Remote Keypad (with its extra connector) can also be remote-mounted up to 3 metres away using a connecting lead: refer to Chapter 3: “Installing the Drive” – Fitting the Remote Keypad.

To remove a Keypad, simply pull it away from the drive. To refit it, push it back into place.

The product rating label identifies the Drive/Keypad type: refer to Chapter 9: “Technical Specifications” – Understanding the Product Code.

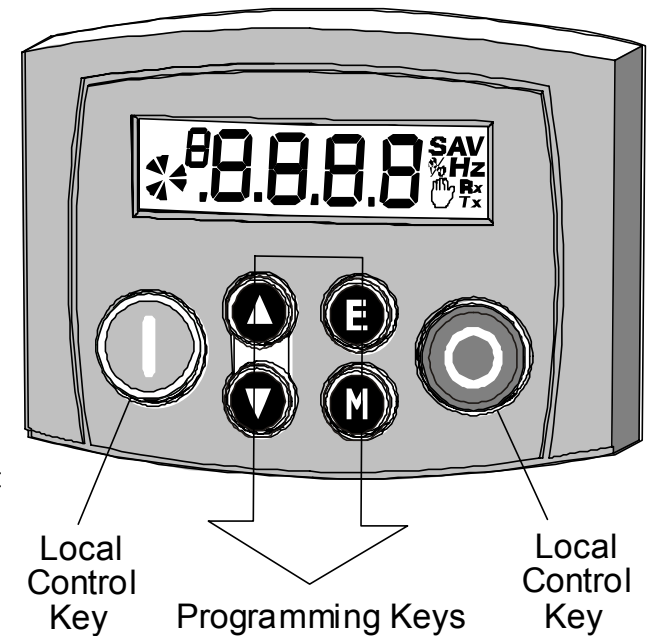







## The Power-Up Condition

On initial power-up, direct from the factory, the drive is in Local Control and the MMI will display the Local Setpoint, **0.0** Hz.

All parameters will be at factory default settings. Any changes to these conditions are automatically saved. The drive will initialise on subsequent power-ups with the previously saved settings and control mode, Local or Remote Control.

# Controlling the Drive using the Keypad

## Control Key Definitions

Key	Operation	Description
	Escape	<i>Navigation</i> – Displays the previous level's menu <i>Parameter</i> – Returns to the parameter list <i>Trip Display</i> – Removes Trip or Error message from display allowing investigation of parameters
	Menu	<i>Navigation</i> – Displays the next menu level, or the first parameter of the current Menu <i>Parameter</i> – Moves cursor to the left when the parameter is adjustable
	Increment	<i>Navigation</i> – Move upwards through the menu system <i>Parameter</i> – Increase value of the displayed parameter <i>Local Mode</i> – Increase value of the local setpoint
	Decrement	<i>Navigation</i> – Move down through the menu system <i>Parameter</i> – Decrease value of the displayed parameter <i>Local Mode</i> – Decrease value of the local setpoint
	Run	<i>Local Mode</i> – Run the drive <i>Trip Reset</i> – Resets trip condition allowing drive to resume operation
	Stop	<i>Local Mode</i> – Stops the drive. Trip Reset in all modes <i>Navigation</i> – Press and hold to toggle between Local and Remote Control modes (refer to page 5.5-10) <i>Trip Reset</i> – Resets trip condition allowing drive to resume operation

## Display Indications

- d** when in the Diagnostics menu
- P** when in the Parameter menu
- S** when in the Setup menu
- A** when displaying an Alarm code
- a negative parameter value

Displays the units for the value:

- S** for time in seconds,    **A** for current in Amps
- V** for voltage in Volts,    **%** for percentage
- Hz** for frequency in Hertz

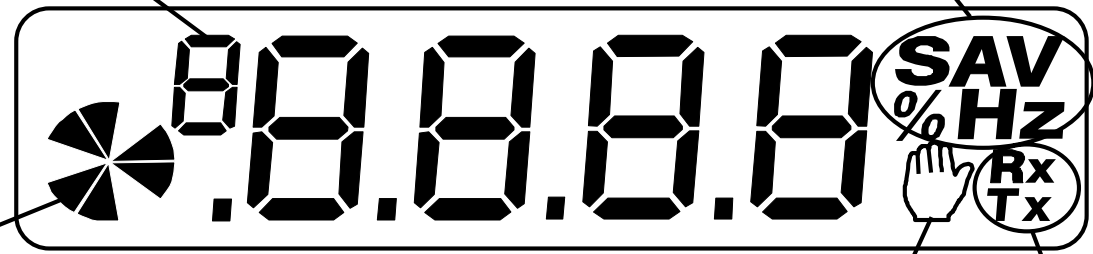

Represents a rotating shaft:  
clockwise = drive running forward  
anticlockwise = drive running in reverse





Indicates parameter numbers or values,  
trip information, error codes etc.  
See "Drive Status Indications" below.

Indicates the drive is in Local control.  
*Drive is in remote control when not visible.*

Indicates control  
via fieldbus  
communications

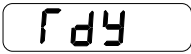
## Drive Status Indications

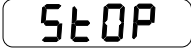
The keypad can display the following status information:

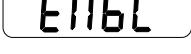
Display	Status Indication and Meaning	Possible Cause
	READY/HEALTHY No alarms present. Remote mode selected	
	PASSWORD Current password must be entered before this parameter may be altered.	Enter password to change the parameter. Refer to page 5.5-11
	LOCAL Local Control selected, healthy, no alarms present	Added or removed from the display letter-by-letter to indicate entering or leaving Local Control
	STOP Coast Stop or Prog Stop active	Jog (6901 op station only) or Run pressed while Coast Stop or Prog Stop lines are active, (low), on the sequencing block. Local control only.
	RUN Not possible to change between Local/Remote mode	The drive is running in Local mode or the Remote run signal is active
	JOG Not possible to change between Local/Remote mode	The Remote jog signal is active
	ENABLE Pressed RUN or JOG key in Local mode while Enable signal is low	The drive Enable signal is inactive, (low)

## The DIAGNOSTICS Menu

Display	Name	Description
0.0 Hz	FREQUENCY	The current output frequency in Hertz
0.0%	SPEED SETPOINT	The set point as a percentage of MAX SPEED
0.0 V	DC LINK VOLTS	$V_{ac} (rms) \times \sqrt{2} = dc \text{ link Volts}$ (when motor stopped)
0.0 A	MOTOR CURRENT	The current load value in Amps

# The Menu System

The menu system is divided into a “tree” structure with 3 menu levels

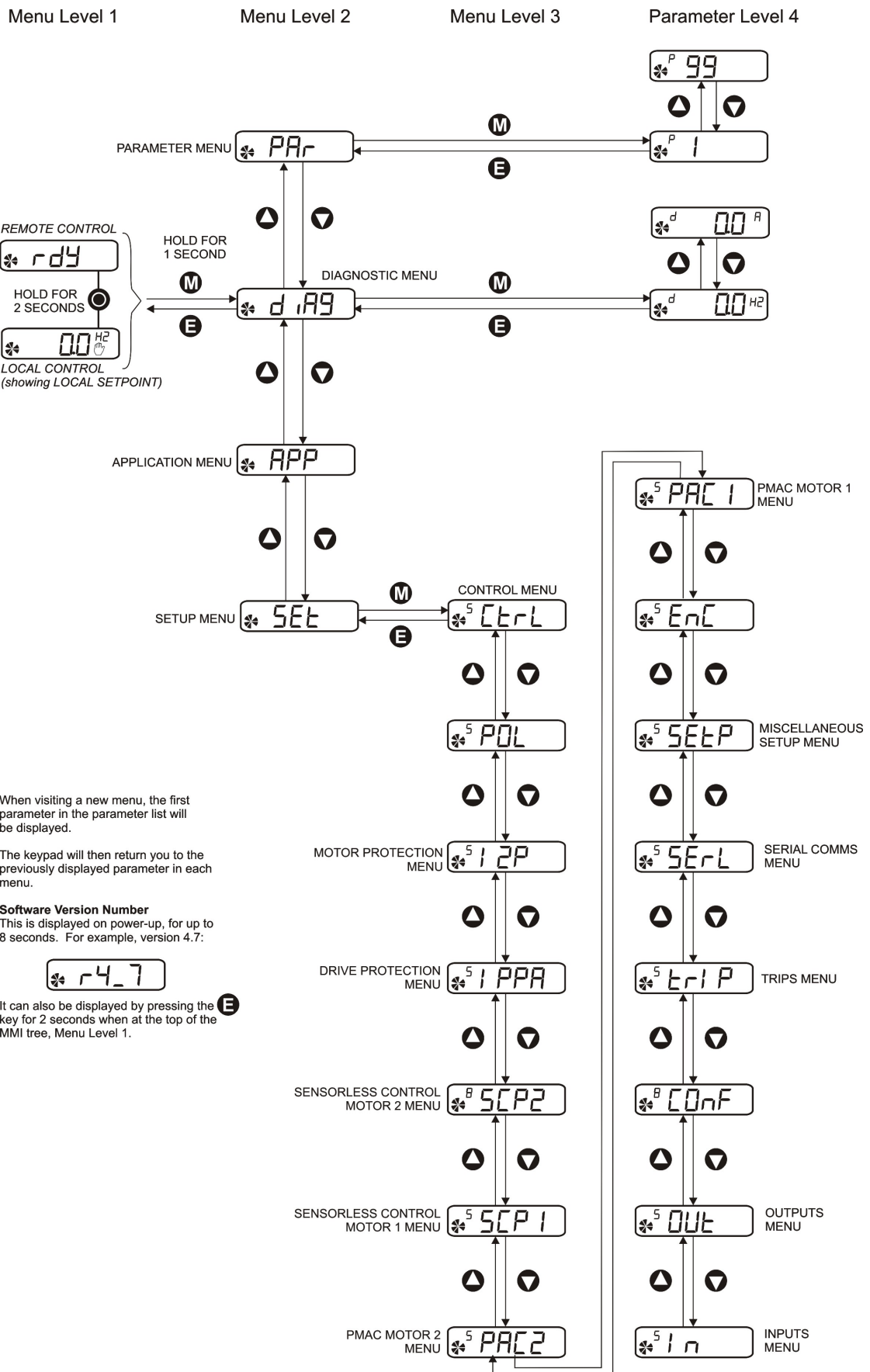

## How To Change a Parameter Value

You can change the values of parameters stored in the **PAR** and **SEt** menus. Refer to Chapter 6: “Programming Your Application” – Configurable Parameters for further information.

- View the parameter to be edited and press **M** to display the parameter’s value.
- Select the digit to be changed (pressing the **M** key moves the cursor from right to left).
- Use the **▲** **▼** keys to adjust the value. Hold the key momentarily to adjust the value marginally, or hold the key to make rapid changes; the rate of change varies with the time held.
- Press **E** to return to the parameter display. The new value is stored.

# Special Menu Features

## Resetting to Factory Defaults (2-button reset)

Power-up the drive whilst holding the keys as shown to return to factory default settings.

This loads Application 1. Then press the  key.

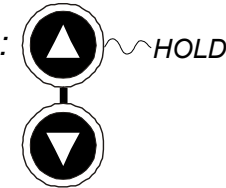

Hold down the keys opposite:  
Power-up the drive, continue  
to hold for at least 1 second



## Changing the Drive Operating Frequency

Power-up the drive whilst holding the keys as shown to display the Engineers Menu.

**IMPORTANT:** *This menu contains sensitive parameters that can dramatically alter the running of the drive.*

This displays parameter <sup>E</sup>0.01. Press the  key to navigate to <sup>E</sup>0.02. Press the  key to edit the parameter: 0 = 50Hz (default), 1 = 60Hz. Select the required frequency then press the  key.

Power-down the drive. No permanent change has been made to the drive at this point. To save the change to parameter <sup>E</sup>0.02, you must now perform a 2-button reset (as above). Please note that this will return the drive to its factory default settings for the selected default frequency.

Hold down the keys opposite:  
Power-up the drive, continue  
to hold for at least 1 second

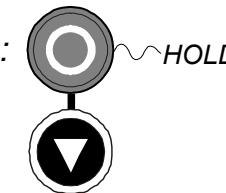



## Selecting Local or Remote Control

The drive can operate in one of two ways:

**Remote Control:** Allowing access for application programming using digital and analog inputs and outputs

**Local Control:** Providing local control and monitoring of the drive using the Keypad

Local control keys are inactive when Remote Control is selected.

In Remote Control, the drive uses a remote setpoint. In Local Control, it uses the Local Setpoint parameter whose value is adjusted on the MMI.

**Note:** You can only change between Local and Remote Control when the drive is “stopped”, and either **rdY** or the Local Setpoint is displayed.

Hold this key down until the display shows **rdY**



Hold this key down until the display spells **LDC**



Release the key to display the Local Setpoint



### Remote to Local Control:

View the Local Setpoint



Hold this key down until **LDC** is removed from the display



Release the key to display **rdY**



### Local to Remote Control:

**Note:** For safety reasons, the drive will not return to Remote Control if this will cause the drive to start. Check RUN and JOG inputs are low.

# Password Protection

When activated, an odd-numbered password prevents unauthorised parameter modification by making all parameters read-only. The local setpoint is not made read-only if an even-numbered password is used. Password protection is set-up using the **P 99** parameter

Steps	ACTIVATE		TEMPORARY DE-ACTIVATION		REMOVE PASSWORD	
	Actions	Display	Actions	Display	Actions	Display
1	Go to <b>P 99</b> Press <b>M</b>	<b>0000</b>	Try to edit any parameter with password activated	<b>PASS →</b> <b>0000</b>	Go to <b>P 99</b> Press <b>M</b>	<b>PASS →</b> <b>0000</b>
2	Enter new password using <b>▲ ▼</b>	<b>000 1</b> for example	Enter current password using <b>▲ ▼</b>	<b>000 1</b> for example	Enter current password using <b>▲ ▼</b>	<b>000 1</b> for example
3	Press <b>E</b> repeatedly until top of menu is reached	<b>r dY</b> , Remote Setpoint or Local Setpoint	Press <b>E</b>	Original parameter displayed, password de-activated	Press <b>E</b> Reset to 0000 using <b>▲ ▼</b>	<b>0000</b>
4	Press <b>E</b> to activate password	<b>r dY</b> , Remote Setpoint or Local Setpoint	<i>A drive will power-up with the last password status. Temporary de-activation is lost on power-down.</i>		Press <b>E</b> to remove password	<b>P 99</b>
	<i>Default = 0000, de-activated Any other value is a password</i>					

## Selecting the Menu Detail

For ease of operation the drive can display full or reduced menus. Refer to Chapter 6 to see how the setting changes the displayed menu. Additional parameters are indicated with **F** in the table.

Navigate to the **St 99** parameter (SET::SETP::ST99) and press the **M** key. This toggles full or partial menu detail. The default setting of 0 provides partial menu detail. Set the parameter to 1 for full menu detail.

# Chapter 6: Programming Your Application

You can program the drive to your specific application. This programming simply involves changing parameter values

Programming Your Application .....	6-2
MMI Parameters.....	6-2
MMI Parameters Table	6-3
Configuring Terminals 9 & 10 (Digital Input/Output)	6-28
PID - Tuning Your Drive	6-30
Auto Restart	6-31
Minimum Speed Mode	6-32
Product-Related Default Values	6-32
* Frequency Dependent Parameters	6-33
** Power Dependent Parameters	6-34

# Programming Your Application

You can program the drive to your specific application. This programming simply involves changing parameter values.

If necessary, there are three parameters for tuning your drive. Refer to PID - Tuning Your Drive, page 6-30.

## Saving Your Modifications

When parameter values are modified, the new settings are saved automatically. The drive will retain the new settings during power-down.

# MMI Parameters









This table provides information about each parameter accessible using the keypad, or MMI (Man Machine Interface). For more information about these and additional parameters accessible using ConfigEd Lite (or other suitable programming tool), refer to the 650S Software Product Manual on our website: [www.SSDdrives.com](http://www.SSDdrives.com).

## Key to MMI Parameters Table

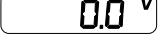
<b>F</b>	Parameters indicated with <b>F</b> are visible with full menus only. Refer to the DETAILED MENUS parameter ( <sup>ST</sup> 99).
<b>M</b>	Parameters indicated with <b>M</b> are Motor Parameters. They are not reset by changing Application using parameter <sup>P</sup> 1; all other parameters are reset to default values.

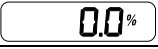
**NOTE** The “Range” for a parameter value is given in the Configurable Parameters Table. Ranges for outputs are given as “—.xx %”, for example, indicating an indeterminate integer for the value, to two decimal places.

# MMI Parameters Table

MMI Parameters Table				
Display	Parameter	Description	Range	Default
<b>DIAG Menu</b>				
	FREQUENCY	The current output frequency in Hertz		
	SPEED SETPOINT	The set point as a percentage of MAX SPEED		
	DC LINK VOLTS	$V_{ac} (rms) \times \sqrt{2} =$ dc link Volts (when motor stopped)		
	MOTOR CURRENT	The current load value in Amps		
<b>DIAG::INPUTS Menu</b>				
	DIN WORD	<b>Four-digit Hexadecimal number to identify the digital input value:</b> 0x0001 is digital input 1 value 0x0002 is digital input 2 value 0x0004 is digital input 3 value 0x0008 is digital input 4 value 0x0010 is digital input 5 value 0x0020 is digital input 6 value 0x0040 is digital input 7 value	—	—
	AIN 1 VALUE	The input reading with scaling and offset applied	—.x%	—.x%
	AIN 2 VALUE	The input reading with scaling and offset applied	—.x%	—.x%
<b>DIAG::OUTPUTS Menu</b>				
	DOUT WORD	<b>Four-digit Hexadecimal number to identify the digital output value:</b> 0x0001 is digital output 1 0x0002 is digital output 2 0x0004 is digital output 3	—	—
	AOUT 1 VALUE	The output value with output and offset applied	—.x%	—.x%
	AOUT 2 VALUE	The output value with output and offset applied)	—.x%	—.x%

## 6-4 Programming Your Application:

MMI Parameters Table				
Display	Parameter	Description	Range	Default
<b>DIAG::TRIPS Menu</b>				
	TRIP1	Records the most recent trip that caused the drive to stop The value displayed is the Trip ID number that can be found in the table 'Hexadecimal Representation of Trips', chapter 7		0
	TRIP2	Records the second most recent trip that caused the drive to stop The value displayed is the Trip ID number that can be found in the table 'Hexadecimal Representation of Trips', chapter 7		0
	TRIP3	Records the third most recent trip that caused the drive to stop The value displayed is the Trip ID number that can be found in the table 'Hexadecimal Representation of Trips', chapter 7		0
	TRIP4	Records the fourth most recent trip that caused the drive to stop The value displayed is the Trip ID number that can be found in the table 'Hexadecimal Representation of Trips', chapter 7		0
	TRIP5	Records the fifth most recent trip that caused the drive to stop The value displayed is the Trip ID number that can be found in the table 'Hexadecimal Representation of Trips', chapter 7		0
	TRIP6	Records the sixth most recent trip that caused the drive to stop The value displayed is the Trip ID number that can be found in the table 'Hexadecimal Representation of Trips', chapter 7		0
	TRIP7	Records the seventh most recent trip that caused the drive to stop The value displayed is the Trip ID number that can be found in the table 'Hexadecimal Representation of Trips', chapter 7		0
	TRIP8	Records the eighth most recent trip that caused the drive to stop The value displayed is the Trip ID number that can be found in the table 'Hexadecimal Representation of Trips', chapter 7		0
	TRIP9	Records the ninth most recent trip that caused the drive to stop The value displayed is the Trip ID number that can be found in the table 'Hexadecimal Representation of Trips', chapter 7		0
	TRIP10	Records the tenth most recent trip that caused the drive to stop The value displayed is the Trip ID number that can be found in the table 'Hexadecimal Representation of Trips', chapter 7		0

MMI Parameters Table				
Display	Parameter	Description	Range	Default
<b>SET::CTRL Menu</b>				
<b>5CL82</b>	POS TORQUE LIMIT	This parameter sets the maximum allowed level of positive motor torque.	-500.0 to 500.0%	200.0%
<b>5CL83</b>	NEG TORQUE LIMIT	This parameter sets the maximum allowed level of negative motor torque.	-500.0 to 500.0%	-200.0%
<b>5CL84</b>	STALL TRIP TYPE <b>F</b>	This parameter determines whether the stall trip operates on motor torque or motor current. FALSE = TORQUE, TRUE = CURRENT	0= FALSE 1= TRUE	1
<b>5CL91</b>	SPEED PROP GAIN <b>FM</b>	Sets the proportional gain of the loop. Speed error (revolutions per second) x proportional gain = torque percent.	0.00 to 300.00	product code dependent
<b>5CL92</b>	SPEED INT TIME <b>FM</b>	This is the integral time constant of the speed loop. A speed error which causes the proportional term to produce a torque demand T, will cause the integral term to also ramp up to a torque demand T after a time equal to "speed int time".	1 to 15000ms	product code dependent
<b>5CL93</b>	SPEED POS LIMIT <b>F</b>	This sets the upper limit of the speed demand.	-110.00 to 110.00%	110.00%
<b>5CL94</b>	SPEED NEG LIMIT <b>F</b>	This sets the lower limit of the speed demand.	-110.00 to 110.00%	-110.00%
<b>SET::IN Menu</b>				
<b>5IPd1</b>	DIN 1 INVERT	Inverts the value of the signal, TRUE or FALSE.	0= FALSE 1= TRUE	0
<b>5IPd2</b>	DIN 2 INVERT	As <sup>S</sup> IP01	As <sup>S</sup> IP01	0
<b>5IPd3</b>	DIN 3 INVERT	As <sup>S</sup> IP01	As <sup>S</sup> IP01	0
<b>5IPd4</b>	DIN 4 INVERT	As <sup>S</sup> IP01	As <sup>S</sup> IP01	0
<b>5IPd5</b>	DIN 5 INVERT	As <sup>S</sup> IP01	As <sup>S</sup> IP01	1
<b>5IPd6</b>	DIN 6 INVERT	As <sup>S</sup> IP01	As <sup>S</sup> IP01	0
<b>5IPd7</b>	DIN 7 INVERT	As <sup>S</sup> IP01	As <sup>S</sup> IP01	0
<b>5IP11</b>	AIN 1 SCALE	<p>0 to 100% of selected TYPE</p>	-300.0 to 300.0%	100.0%
<b>5IP12</b>	AIN 1 OFFSET		-300.0 to 300.0%	0.0%
<b>5IP13</b>	AIN 1 TYPE		0= 0-10V 1= 0-5V	0



## 6-6 Programming Your Application:

MMI Parameters Table				
Display	Parameter	Description	Range	Default
5 IP21	AIN 2 SCALE	<p>UNPROCESSED INPUT → [X] → [+] → VALUE</p> <p>0 to 100% of selected TYPE</p>	-300.0 to 300.0%	100.0%
5 IP22	AIN 2 OFFSET		-300.0 to 300.0%	0.0%
5 IP23	AIN 2 TYPE		0= 0-10V 1= 0-5V 2= 0-20mA 3= 4-20mA	3
SET::OUT Menu				
5 OPd1	DOUT 1 INVERT	Inverts the value of the signal, TRUE or FALSE.	0= FALSE 1= TRUE	0
5 OPd2	DOUT 2 INVERT	Inverts the value of the signal, TRUE or FALSE.	0= FALSE 1= TRUE	0
5 OPd3	RELAY INVERT	Inverts the value of the signal, TRUE or FALSE.	0=FALSE 1=TRUE	0
5 OP11	AOUT 1 SCALE	<p>VALUE → [X] → [+] → [ X ] → CLAMP → OUTPUT</p> <p>CLAMP: 0% to 100%</p>	-300.00 to 300.00%	100.00%
5 OP12	AOUT 1 OFFSET		-300.00 to 300.00%	0.00%
5 OP13	AOUT 1 ABSOLUTE		0= FALSE (not absolute) 1= TRUE (absolute)	1
5 OP21	AOUT 2 SCALE	<p>VALUE → [X] → [+] → [ X ] → CLAMP → OUTPUT</p> <p>CLAMP: 0% to 100%</p>	-300.00 to 300.00%	100.00%
5 OP22	AOUT 2 OFFSET		-300.00 to 300.00%	0.00%
5 OP23	AOUT 2 ABSOLUTE		0= FALSE (not absolute) 1= TRUE (absolute)	1

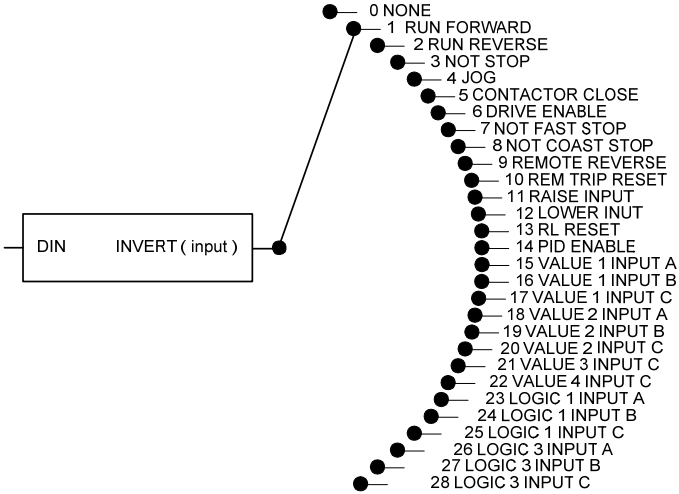
MMI Parameters Table				
Display	Parameter	Description	Range	Default
<b>SET::CONF Menu</b>				
\$ IPd1	F	 <ul style="list-style-type: none"> <li>0 NONE</li> <li>1 RUN FORWARD</li> <li>2 RUN REVERSE</li> <li>3 NOT STOP</li> <li>4 JOG</li> <li>5 CONTACTOR CLOSE</li> <li>6 DRIVE ENABLE</li> <li>7 NOT FAST STOP</li> <li>8 NOT COAST STOP</li> <li>9 REMOTE REVERSE</li> <li>10 REM TRIP RESET</li> <li>11 RAISE INPUT</li> <li>12 LOWER INPUT</li> <li>13 RL RESET</li> <li>14 PID ENABLE</li> <li>15 VALUE 1 INPUT A</li> <li>16 VALUE 1 INPUT B</li> <li>17 VALUE 1 INPUT C</li> <li>18 VALUE 2 INPUT A</li> <li>19 VALUE 2 INPUT B</li> <li>20 VALUE 2 INPUT C</li> <li>21 VALUE 3 INPUT C</li> <li>22 VALUE 4 INPUT C</li> <li>23 LOGIC 1 INPUT A</li> <li>24 LOGIC 1 INPUT B</li> <li>25 LOGIC 1 INPUT C</li> <li>26 LOGIC 3 INPUT A</li> <li>27 LOGIC 3 INPUT B</li> <li>28 LOGIC 3 INPUT C</li> </ul>	0 : NONE 1 : RUN FORWARD 2 : RUN REVERSE 3 : NOT STOP 4 : JOG 5 : CONTACTOR CLOSE 6 : DRIVE ANABLE 7 : NOT FAST STOP ..... 28 LOGIC 3 INPUT C	1 : RUN FORWARD Default FORWARD
\$ IPd2	F	DIN 2 DESTINATION	Same as DIN1 DESTINATION	2 : RUN REVERSE
\$ IPd3	F		Same as DIN 1 DESTINATION	4 : JOG
\$ IPd4	F		Same as DIN 1 DESTINATION	3 : NOT STOP
\$ IPd5	F		Same as DIN 1 DESTINATION	8 : NOT COAST STOP
\$ IPd6	F		Same as DIN 1 DESTINATION	0 : NONE
\$ IPd7	F		Same as DIN 1 DESTINATION	0 : NONE

# 6-8 Programming Your Application:

MMI Parameters Table					
Display	Parameter	Description	Range	Default	
50Pd1	F	<p>NONE : Relay is open  <i>Relay is closed when:</i>                      HEALTH : the Run signal is not present, or no trip is active                      TRIPPED : a trip is present                      RUNNING : the motor is running                      AT ZERO : the output frequency is below 1% of MAX SPEED (<sup>P2</sup>)                      AT SPEED : the output frequency is at or near Setpoint and within ±1% of MAX SPEED, set by (<sup>P2</sup>). For example: if MAX SPEED = 50Hz and Setpoint = 30Hz, then 1% of MAX SPEED = 0.5Hz. So AT LOAD is True between 30 ±0.5Hz.                      AT LOAD : the magnitude of the output torque is greater than or equal to the torque level set in <sup>ST42</sup></p>	0 : NONE 1 : HEALTH 2 : TRIPPED 3 : RUNNING 4 : AT ZERO 5 : AT SPEED 6 : AT LOAD	0 : NONE	
50Pd2	Refer to Configuring Terminals 9 & 10 (Digital Input/Output), page 5-6-28 F		0 : NONE 1 : HEALTH 2 : TRIPPED 3 : RUNNING 4 : AT ZERO 5 : AT SPEED 6 : AT LOAD	0 : NONE	0 : NONE
50Pd3	F		0 : NONE 1 : HEALTH 2 : TRIPPED 3 : RUNNING 4 : AT ZERO 5 : AT SPEED 6 : AT LOAD	0 : NONE	1 : HEALTH
50PA1	F		SCALE 50P11 OFFSET 50P12 ABSOLUTE 50P13	0 : NONE	1 : DEMAND
			0 : NONE 1 : DEMAND 2 : CURRENT 3 : PID ERROR 4 : RAISE/LOWER	1 : DEMAND	1 : DEMAND

MMI Parameters Table				
Display	Parameter	Description	Range	Default
			SCALE OFFSET ABSOLUTE	0 : NONE 1 : DEMAND 2 : CURRENT 3 : PID ERROR 4 : RAISE/LOWER
<b>SET::TRIP Menu</b>				
	DISABLE LOOP	Disables LOST I LOOP trip (4-20mA)	0= TRIP ENABLED 1= TRIP DISABLED	1
	AIN2 OVERLOAD	Disables the overload trip (Terminal 3)	As <sup>S</sup> LOOP	0
	DISABLE STALL	Disables STALL trip	As <sup>S</sup> LOOP	0
	DISABLE MOTOR OVERTEMP	Disables the motor thermistor trip	As <sup>S</sup> LOOP	0
	INVERSE TIME	Disables the inverse time trip	As <sup>S</sup> LOOP	1
	DYNAMIC BRAKE RESISTOR	Disables the dynamic brake resistor trip	As <sup>S</sup> LOOP	1
	DYNAMIC BRAKE SWITCH	Disables the dynamic brake switch trip	As <sup>S</sup> LOOP	1
	SPEED FEEDBACK	Disables the speed feedback trip	As <sup>S</sup> LOOP	0
	OVERSPEED	Disables the overspeed trip	As <sup>S</sup> LOOP	0
	DISPLAY (KEYPAD)	Disables the display (keypad) trip	As <sup>S</sup> LOOP	0
	DC LINK RIPPLE	Disables the DC link ripple trip	As <sup>S</sup> LOOP	0
<b>SET::SERL Menu</b>				
	REMOTE COMMS SEL	Selects the type of remote communications mode: 0 : FALSE, and in REMOTE mode then control is from the terminals. 1 : TRUE, and in REMOTE mode then control is from the communications.	0=FALSE 1=TRUE	0
	COMMS TIMEOUT	Sets the maximum time allowed between refreshing the COMMS COMMAND parameter. The drive will trip if this time is exceeded. Set the time to 0.00 seconds to disable this feature.	0.0 to 600.0s	0.0s
	COMMS ADDRESS	The drives identity address. Note: if set to 0, it will only respond to broadcast messages.	0 to 255	0







## 6-10 Programming Your Application:

MMI Parameters Table				
Display	Parameter	Description	Range	Default
<b>5SE04</b>	BAUD RATE F	Selects the Baud Rate for the MODBUS protocol.	0 : 1200 1 : 2400 2 : 4800 3 : 7200 4 : 9600 5 : 14400 6 : 19200 7 : 38400 8 : 57600	4
<b>5SE05</b>	PARITY F	Selects the Parity for the MODBUS protocol.	0= NONE 1= ODD 2= EVEN	0
<b>5SE06</b>	REPLY DELAY ms	The time in milliseconds between the drive receiving the complete request from the communications master (PLC/PC) and replying to this request.	0 to 200	5
<b>5SE07</b>	OP PORT PROTOCOL F	Selects the protocol to be used by the keypad port on the front of the drive. When EIBISYNC ASCII is selected, BAUD RATE is 19200 and PARITY is EVEN. FIELD BUS is reserved for future use.	0= AUTOMATIC 1= KEYPAD 2=EIBISYNC ASCII 3= MODBUS 4= FIELD BUS	0
<b>5SE08</b>	P3 PORT PROTOCOL F	Selects the protocol to be used by the RS232 programming port on the drive's control board. When EIBISYNC ASCII is selected, BAUD RATE is 19200 and PARITY is EVEN. FIELD BUS is reserved for future use.	As 5SE07	0

SET::SETP Menu				
<b>5SE01</b>	JOG ACCEL TIME	As P4, for Jog	0.0 to 3000.0s	1.0
<b>5SE02</b>	JOG DECEL TIME	As P5, for Jog	0.0 to 3000.0s	1.0
<b>5SE03</b>	RAMP TYPE	Selects the ramp type	0=LINEAR 1=S	0
<b>5SE04</b>	S RAMP JERK	Rate of change of acceleration of the curve in units per second <sup>3</sup>	0.01 to 100.00 s <sup>3</sup>	10.00
<b>5SE05</b>	S RAMP CONTINUOUS	When TRUE and the S ramp is selected, forces a smooth transition if the speed setpoint is changed when ramping. The curve is controlled by the S RAMP JERK parameter. When FALSE, there is an immediate transition from the old curve to the new curve	0=FALSE 1=TRUE	1
<b>5SE06</b>	MIN SPEED MODE	Selects a mode to determine how the drive will follow a reference: Proportional : minimum limit, Linear : between minimum and maximum.	0=PROP.W/MIN. 1=LINEAR (used by the 601 product)	0
<b>5SE11</b>	SKIP FREQUENCY 1	This parameter contains the centre frequency of skip band 1 in Hz	0.0 to 240.0 Hz	0.0

MMI Parameters Table				
Display	Parameter	Description	Range	Default
55E12	SKIP FREQUENCY BAND 1	The width of skip band 1 in Hz	0.0 to 60.0 Hz	0.0
55E13	SKIP FREQUENCY 2	This parameter contains the centre frequency of skip band 2 in Hz	0.0 to 240.0 Hz	0.0
55E14	SKIP FREQUENCY BAND 2	The width of skip band 2 in Hz	0.0 to 60.0 Hz	0.0
55E21	AUTO RESTART ATTEMPTS	Determines the number of restarts that will be permitted before requiring an external fault reset	0 to 10	0
55E22	AUTO RESTART DELAY	Determines the delay between restart attempts for a trip included in AUTO RESTART TRIGGERS and AUTO RESTART TRIGGERS+. The delay is measured from all error conditions clearing	0.0 to 600.0 s	10.0
55E23	AUTO RESTART TRIGGERS	Allows Auto Restart to be enabled for a selection of trip conditions. Refer to Chapter 7: "Trips and Fault Finding" - Hexadecimal Representation of Trips	0x0000 to 0xFFFF	0x0000
55E24	AUTO RESTART TRIGGERS+	Allows Auto Restart to be enabled for a selection of trip conditions. Refer to Chapter 7: "Trips and Fault Finding" - Hexadecimal Representation of Trips	0x0000 to 0xFFFF	0x0000
55E31	DB ENABLE	Enables operation of the dynamic braking.	0=FALSE 1=TRUE	1
55E32	DB RESISTANCE	The value of the load resistance.	1 to 1000	product code dependent
55E33	DB POWER	The power that the load resistance may continually dissipate.	0.1 to 510.0 kW	product code dependent
55E34	DB OVER-RATING	Multiplier that may be applied to DB POWER for power overloads lasting no more than 1 second.	1 to 40	25
55E51	LOCAL MIN SPEED	The magnitude of the minimum setpoint that will be used when running in Local Mode.	0.0 to 100.0 %	0.0 %
55E52	ENABLED KEYS	The following keys on the 6901 keypad can be enabled or disabled separately. The combination produces the parameter setting as in the table below. The default of FFFF enables all keys.	0000 to FFFF	FFFF

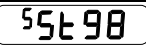
## 6-12 Programming Your Application:

MMI Parameters Table							
Display	Parameter	Description	Range			Default	
 <p>6901</p>  <p>6911</p>	Parameter Setting	RUN	L/R	JOG	DIR		
	0000	-	-	-	-	-	
	0010	-	-	-	ENABLED	ENABLED	
	0020	-	-	-	ENABLED	-	
	0030	-	-	-	ENABLED	ENABLED	
	0040	-	-	ENABLED	-	-	
	0050	-	-	ENABLED	-	ENABLED	
	0060	-	-	ENABLED	ENABLED	-	
	0070	-	-	ENABLED	ENABLED	ENABLED	
	0080	ENABLED	-	-	-	-	
	0090	ENABLED	-	-	-	ENABLED	
	00A0	ENABLED	-	-	ENABLED	-	
	00B0	ENABLED	-	-	ENABLED	ENABLED	
	00C0	ENABLED	ENABLED	-	-	-	
	00D0	ENABLED	ENABLED	ENABLED	-	ENABLED	
	00E0	ENABLED	ENABLED	ENABLED	ENABLED	-	
	00F0	ENABLED	ENABLED	ENABLED	ENABLED	ENABLED	
 <p>6511</p>		<p>When using the standard 6511 and 6521 keypad, disabling the <b>DIR</b> key prevents the local setpoint going negative (for reverse). Similarly, disabling the <b>L/R</b> key prevents the drive being changed from Local to Remote, or Remote to Local modes.</p>					
 <p>6521</p>							
	APPLICATION LOCK	Setting this parameter to TRUE prevents editing of parameter <sup>P</sup> 1. Set this parameter to FALSE to edit parameter <sup>P</sup> 1.			0=FALSE 1=TRUE	0	
	DETAILED MENUS	Selects Full menu detail when TRUE. The additional parameters in the Full menus are indicated in this table by			0=FALSE 1=TRUE	0	

MMI Parameters Table				
Display	Parameter	Description	Range	Default
<b>SET::ENC Menu</b>				
<b>SENO1</b>	ENC MODE <b>F</b>	Set this parameter to the requirements for your encoder: 0 : QUADRATURE (using digital inputs 6 & 7, ENCA and ENCB respectively) 1 : CLOCK/DIR (using digital inputs 6 & 7, ENCA and ENCB respectively) 2 : CLOCK (using digital input 6, ENCA)	0= QUADRATURE 1= CLOCK/DIR 2= CLOCK	0
<b>SENO2</b>	ENC RESET <b>F</b>	When TRUE the POSITION and SPEED outputs are set (and held) at zero.	0=FALSE 1=TRUE	0
<b>SENO3</b>	ENC INVERT <b>F</b>	When TRUE, changes the sign of the measured speed and the direction of the position count.	0=FALSE 1=TRUE	0
<b>SENO4</b>	ENC LINES <b>F</b>	The number of lines must be set to match the type of encoder being used. Incorrect setting of this parameter will result in an erroneous speed measurement.	100 to 10000	100
<b>SENO5</b>	ENC SPEED SCALE <b>F</b>	This parameter allows the output "speed" to be scaled to any value the user requires. With a default value of 1.00, the output "speed" is measured in revs per second. Changing the ENC SPEED SCALE value to 60.00 will provide an output in revs per minute.  To provide an output in percent of the motor maximum speed, where maximum speed is the maximum speed your motor will run in rpm, the ENC SPEED SCALE parameter should be set to the result of:  $\frac{6000}{\text{maximum speed (rpm)}}$	0.00 to 300.00	1.00
<b>SENO6</b>	ENC SPEED <b>F</b>	Speed feedback, in units defined by the ENC SPEED SCALE parameter.	—.x	—.x
<b>SET::PAC1 Menu</b>				
<b>SPAO1</b>	MAX SPEED MOTOR1 <b>M</b>	Set the maximum motor 1 speed.	0 to 30000 RPM	3200RPM
<b>SPAO2</b>	MAX CURRENT MOTOR1 <b>M</b>	Set the motor 1 maximum current in Amps rms.	1.0 to 512.0 Arms	5.65A
<b>SPAO3</b>	PERM CURRENT MOTOR1 <b>M</b>	Set the motor 1 nominal current in Amps rms.	1.0 to 512.0 Arms	2.43A



## 6-14 Programming Your Application:

MMI Parameters Table				
Display	Parameter	Description	Range	Default
SPR04	PERM TORQUE MOTOR1 M	Set the motor 1 nominal torque in Nm.	1.0 to 512.0 Nm	2.0Nm
SPR05	POLES MOTOR1 M	Set the motor 1 number of poles.	0 to 400	10
SPR06	BACK EMF MOTOR1 M	Set the motor1's Back EMF phase to phase, rms value (in Volts/1000RPM)	0 to 8192 Vrms/1000RPM	50.9V
SPR07	R MOTOR1 M	Set the motor1's resistance, between phase at 25°C.	0 to 50 Ohms	6.58Ohms
SPR08	L MOTOR1 M	Set the motor1's inductance, between phase at nominal current.	0 to 1000mH	20.3mH
SPR09	KT MOTOR1 M	Set the motor1's torque constant in Nm/Amps rms	0 to 100 NM/Arms	0.848NM/ A
SPR10	INERTIA MOTOR1 M	Set the motor1's inertia. The units for this parameter are set by the INERTIA SCALE parameter.	0 to 100	0.070
SPR11	INERTIA SCALE MOTOR1 M	Set the motor1's inertia scale: 0 = gm <sup>2</sup> 1 = kgcm <sup>2</sup> 2 = kgm <sup>2</sup>		0
SPR12	THERMAL TIME CST MOTOR1 M	This parameter is used for the motor1 protection, e.g. I2T motor load. It defines the thermal time constant of the motor1 that is used to protect the motor1 against overheating. Refer to the PMAC MOT PROTECT for a definition.	0 to 10000 s	62s
SPR13	CUR LOOP BWDTH MOTOR1 M	Set the current loop bandwidth in Hz. This value will automatically generate the proportional gain of the PI corrector of the current loop. The proportional gain is calculated based on the 'L' motor 2 parameter. Modifying this value could induce instability. Please contact Parker SSD Drives if you need to change it.	10 to 1500 Hz	400Hz
SPR14	INTEGRAL FREQ MOTOR1 M	Set the frequency of the I term of the PI current loop corrector. The ratio CUR LOOP BWDTH/INTEGRAL FREQ must be kept higher than 3. Modifying this value could induce instability. Please contact Parker SSD Drives if you need to change it.	1 to 600 Hz	100Hz

MMI Parameters Table				
Display	Parameter	Description	Range	Default
SPAS15	SELECT MOTOR1 M	Used to select the motor to run:  0 = motor 2 is selected, e.g. SV Motor Data 2 and SV Motor Ctrl 2 parameters are used by the drive  1 = motor 1 is selected, e.g. SV Motor Data 1 and SV Motor Ctrl 1 parameters are used by the drive		1
<b>SET::PAC2 Menu</b>				
SPAS1	MAX SPEED MOTOR2 M	Set the maximum motor 2 speed.	0 to 30000 RPM	4000RPM
SPAS2	MAX CURRENT MOTOR2 M	Set the motor 2 maximum current in Amps rms.	1.0 to 512.0 Arms	10.6A
SPAS3	PERM CURRENT MOTOR2 M	Set the motor 2 nominal current in Amps rms.	1.0 to 512.0 Arms	5.24A
SPAS4	PERM TORQUE MOTOR2 M	Set the motor 2 nominal torque in Nm.	1.0 to 512.0 Nm	5.5Nm
SPAS5	POLES MOTOR2 M	Set the motor 2 number of poles.	0 to 400	10
SPAS6	BACK EMF MOTOR2 M	Set the motor2's Back EMF phase to phase, rms value (in Volts/1000RPM)	0 to 8192 Vrms/1000RPM	65.5V
SPAS7	R MOTOR2 M	Set the motor2's resistance, between phase at 25°C.	0 to 50 Ohms	2.19Ohms
SPAS8	L MOTOR2 M	Set the motor2's inductance, between phase at nominal current.	0 to 1000mH	10.9mH
SPAS9	KT MOTOR2 M	Set the motor2's torque constant in Nm/Amps rms	0 to 100 NM/Arms	1.075Nm/A
SPAS0	INERTIA MOTOR2 M	Set the motor2's inertia. The units for this parameter are set by the INERTIA SCALE parameter.	0 to 100	0.40

## 6-16 Programming Your Application:

MMI Parameters Table				
Display	Parameter	Description	Range	Default
SPAG1	INERTIA SCALE MOTOR2 M	Set the motor2's inertia scale: 0 = gm <sup>2</sup> 1 = kgcm <sup>2</sup> 2 = kgm <sup>2</sup>		0
SPAG2	THERMAL TIME CST MOTOR2 M	This parameter is used for the motor2 protection, e.g. I2T motor load. It defines the thermal time constant of the motor1 that is used to protect the motor1 against overheating. Refer to the PMAC MOT PROTECT for a definition.	0 to 10000 s	76.4s
SPAG3	CUR LOOP BWDTH MOTOR2 M	Set the current loop bandwidth in Hz. This value will automatically generate the proportional gain of the PI corrector of the current loop. The proportional gain is calculated based on the 'L' motor 2 parameter. Modifying this value could induce instability. Please contact Parker SSD Drives if you need to change it.	10 to 1500 Hz	400Hz
SPAG4	INEGRAL FREQ MOTOR2 M	Set the frequency of the I term of the PI current loop corrector. The ratio CUR LOOP BWDTH/INTEGRAL FREQ must be kept higher than 3. Modifying this value could induce instability. Please contact Parker SSD Drives if you need to change it.	1 to 600 Hz	100Hz

MMI Parameters Table				
Display	Parameter	Description	Range	Default
<b>SET::SCP1 Menu</b>				
\$5C01	TRIP INHIBIT MOTOR1	This parameter is used to inhibit/enable the SV trip.	0=FALSE 1=TRUE	0
\$5C02	LPF SPEED MOTOR1	Set the Low Pass Filter frequency applied on the estimated speed. The default value is appropriate for most motors.	0.1 to 1000.0 Hz	60Hz
\$5C03	PI GAIN MOTOR1	Set the Proportional gain of the PI corrector used for extracting speed and position. The default value is appropriate for most motors.	0 to 2000	1
\$5C04	PI INTEGRAL MOTOR1	Set the Integral frequency of the PI corrector used for extracting speed and position. The default value is appropriate for most motors	1 to 2000 Hz	20Hz
\$5C05	SPD THRESHOLD MOTOR1	Set the threshold value used to enable/disable the I term of the PI corrector (used for extracting speed and position).	0 to 30000 RPM	200RPM

The default value is appropriate for most motors (2000 to 6000RPM). It can be changed to the Nominal motor speed divided by 20 to 30.

## 6-18 Programming Your Application:

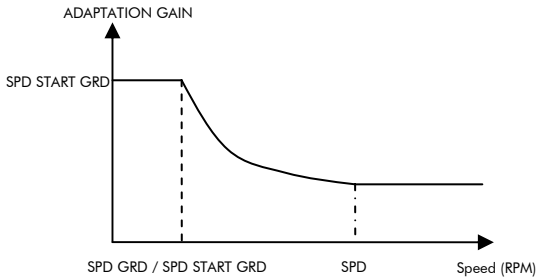
MMI Parameters Table				
Display	Parameter	Description	Range	Default
55C06	SPD START GRAD MOTOR1	<p>The gain of the PI corrector varies as 1 over speed. To maintain the PI gain at a constant value over the whole range of the speed, the gain is internally varied as a function of the speed. This parameter is used to determine where the 1/X variation is starting to work (because of zero and low speed behaviour of the estimation). The default value is 5, and is considered appropriate for most applications.</p>  <p>The total gain applied is: <math>PI\ GAIN * ADAPTATION\ GAIN</math></p> <p>With:</p> <p><math>ADAPTATION\ GAIN = SPD\ START\ GRAD</math> from 0 to <math>SPD\ GRD / SPD\ START\ GRAD</math></p> <p><math>ADAPTATION\ GAIN = SPD\ GRD / real\_speed\ (RPM)</math> from <math>SPD\ GRD / SPD\ START\ GRAD</math> to <math>SPD\ GRD</math></p> <p><math>ADAPTATION\ GAIN = 1</math> above <math>SPD\ GRD</math></p>	0.1 to 100	5
55C08	SPD GRD MOTOR1	<p>The gain of the PI corrector varies as 1 over speed. To maintain the PI gain at a constant value over the whole range of the speed, the gain is internally varied as a function of the speed.</p> <p>This parameter is used to select the speed where the <math>GAIN\_ADAPTATION</math> is kept constant and equal to 1 (see graph below). This value must be set to the nominal motor or application speed.</p>	-32000 to 32000 RPM	4000RPM

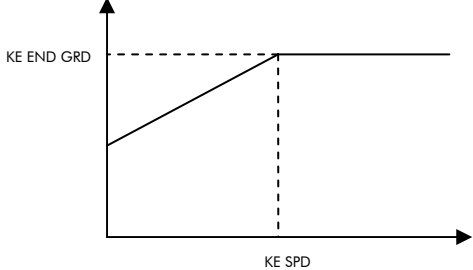
MMI Parameters Table				
Display	Parameter	Description	Range	Default
55C09	KE START GRD MOTOR1	<p>This parameter is used to vary the Back EMF versus speed used in the SV algorithm.</p> <p>The default value of 0.2 is considered appropriate for most applications.</p> 	0 to 100	0.2
55C10	KE END GRD MOTOR1	<p>This parameter is used to vary the Back EMF versus speed used in the SV algorithm.</p> <p>The default value of 1.0 is considered appropriate for most applications.</p>	0 to 100	1
55C11	KE SPD MOTOR1	<p>This parameter is used to vary the Back EMF versus speed used in the SV algorithm. It defines the speed at which the variation stops. The default value is 50 RPM, and is considered appropriate for most applications.</p> <p>As it is mostly used to start the motor, a very low value (between 0 to 100RPM) must be selected if changed from the default value.</p>	-32000 to 32000 RPM	50RPM
55C12	ENABLE STARTUP MOTOR1	<p><b>Start the motor with a high friction load</b></p> <p>This parameter is used to enable/disable a specific startup procedure when the motor/drive is switched ON (starting rotation). This is mainly used where applications need to start the motor with a high inertia and/or friction load and the standard start is ineffective.</p> <p>This parameter is also used to work in up – down motion, where we need to go down to zero speed or crossing the zero speed point.</p>	0=FALSE 1=TRUE	FALSE

MMI Parameters Table				
Display	Parameter	Description	Range	Default
55C 13	STARTUP TIME MOTOR1	<p>This parameter is used in conjunction with the ENABLE STARTUP parameter. It selects the duration of Step 1 and Step 2 in the startup procedure used for starting motors with a high inertia and/or friction load:</p> <ul style="list-style-type: none"> <li>- half the time for the current ramping</li> <li>- half the time for the position variation on one electrical turn</li> </ul> <p>The value is dependant upon the motor inertia + load inertia.</p>	0 to 100s	0.5s
55C 14	STARTUP CURRENT MOTOR1	<p>This parameter is used in conjunction with the ENABLE STARTUP parameter. It selects the current level during the startup procedure used for starting motors with a high inertia and/or friction load.</p> <p>The percentage value is a percentage of the nominal motor current (I0 of the PMAC MOTOR function block)</p> <p>This value cannot be higher than 150% of the drive rating.</p> <p>The default value of 10% is considered appropriate for most applications.</p>	0 to 200%	10%
55C 15	STARTUP SPEED MOTOR1	<p>This parameter is used in conjunction with the ENABLE STARTUP parameter. It selects the speed setpoint at which the speed control is switched from an open loop mode to a closed loop mode during the startup procedure used for starting motors with a high inertia and/or friction load..</p> <p>The percentage value is a percentage of the maximum application speed (MAX SPEED of the REFERENCE function block )</p> <p>In open loop mode, the system is not controlled in speed mode. It must only be used to 'start' the motor under heavy conditions, or to transitorily reach the zero speed or crossing the zero speed setpoint. It is not intended to be used to control accurately a motion.</p>	0 to 100%	5%

MMI Parameters Table				
Display	Parameter	Description	Range	Default
<b>SET::SCP2 Menu</b>				
\$5C51	TRIP INHIBIT MOTOR2	This parameter is used to inhibit/enable the SV trip.	0=FALSE 1=TRUE	0
\$5C52	LPF SPEED MOTOR2	Set the Low Pass Filter frequency applied on the estimated speed. The default value is appropriate for most motors.	0.1 to 1000.0 Hz	60Hz
\$5C53	PI GAIN MOTOR2	Set the Proportional gain of the PI corrector used for extracting speed and position. The default value is appropriate for most motors.	0 to 2000	1
\$5C54	PI INTEGRAL MOTOR2	Set the Integral frequency of the PI corrector used for extracting speed and position. The default value is appropriate for most motors	1 to 2000 Hz	20Hz
\$5C55	SPD THRESHOLD MOTOR2	Set the threshold value used to enable/disable the I term of the PI corrector (used for extracting speed and position).	0 to 30000 RPM	200RPM

The default value is appropriate for most motors (2000 to 6000RPM). It can be changed to the Nominal motor speed divided by 20 to 30.

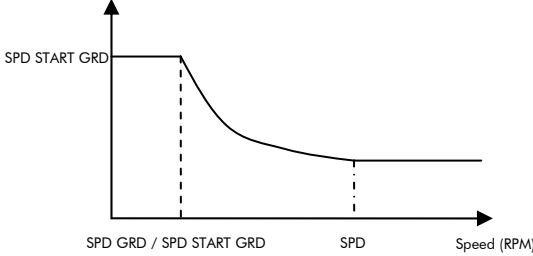

## 6-22 Programming Your Application:

MMI Parameters Table				
Display	Parameter	Description	Range	Default
55C56	SPD START GRAD MOTOR2	<p>The gain of the PI corrector varies as 1 over speed. To maintain the PI gain at a constant value over the whole range of the speed, the gain is internally varied as a function of the speed. This parameter is used to determine where the 1/X variation is starting to work (because of zero and low speed behaviour of the estimation). The default value is 5, and is considered appropriate for most applications.</p>  <p>The total gain applied is: <math>PI\ GAIN * ADAPTATION\ GAIN</math></p> <p>With:</p> <p><math>ADAPTATION\ GAIN = SPD\ START\ GRD</math> from 0 to <math>SPD\ GRD / SPD\ START\ GRD</math></p> <p><math>ADAPTATION\ GAIN = SPD\ GRD / real\_speed\ (RPM)</math> from <math>SPD\ GRD / SPD\ START\ GRD</math> to <math>SPD\ GRD</math></p> <p><math>ADAPTATION\ GAIN = 1</math> above <math>SPD\ GRD</math></p>	0.1 to 100	5
55C58	SPD GRD MOTOR2	<p>The gain of the PI corrector varies as 1 over speed. To maintain the PI gain at a constant value over the whole range of the speed, the gain is internally varied as a function of the speed.</p> <p>This parameter is used to select the speed where the <math>GAIN\_ADAPTATION</math> is kept constant and equal to 1 (see graph below). This value must be set to the nominal motor or application speed.</p>	-32000 to 32000 RPM	4000RPM

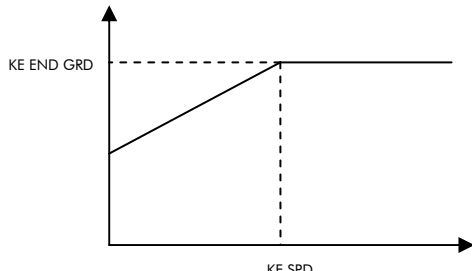
MMI Parameters Table				
Display	Parameter	Description	Range	Default
\$5C59	KE START GRD MOTOR2	<p>This parameter is used to vary the Back EMF versus speed used in the SV algorithm.</p> <p>The default value of 0.2 is considered appropriate for most applications.</p> 	0 to 100	0.2
\$5C60	KE END GRD MOTOR2	<p>This parameter is used to vary the Back EMF versus speed used in the SV algorithm.</p> <p>The default value of 1.0 is considered appropriate for most applications.</p>	0 to 100	1
\$5C61	KE SPD MOTOR2	<p>This parameter is used to vary the Back EMF versus speed used in the SV algorithm. It defines the speed at which the variation stops. The default value is 50 RPM, and is considered appropriate for most applications.</p> <p>As it is mostly used to start the motor, a very low value (between 0 to 100RPM) must be selected if changed from the default value.</p>	-32000 to 32000 RPM	50RPM
\$5C62	ENABLE STARTUP MOTOR2	<p><b>Start the motor with a high friction load</b></p> <p>This parameter is used to enable/disable a specific startup procedure when the motor/drive is switched ON (starting rotation). This is mainly used where applications need to start the motor with a high inertia and/or friction load and the standard start is ineffective.</p> <p>This parameter is also used to work in up – down motion, where we need to go down to zero speed or crossing the zero speed point.</p>	0=FALSE 1=TRUE	FALSE
\$5C63	STARTUP TIME MOTOR2	<p>This parameter is used in conjunction with the ENABLE STARTUP parameter. It selects the duration of Step 1 and Step 2 in the startup procedure used for starting motors with a high inertia and/or friction load:</p> <ul style="list-style-type: none"> <li>- half the time for the current ramping</li> <li>- half the time for the position variation on one electrical turn</li> </ul> <p>The value is dependant upon the motor inertia + load inertia.</p>	0 to 100s	0.5s

## 6-24 Programming Your Application:

MMI Parameters Table				
Display	Parameter	Description	Range	Default
55C64	STARTUP CURRENT MOTOR2	<p>This parameter is used in conjunction with the ENABLE STARTUP parameter. It selects the current level during the startup procedure used for starting motors with a high inertia and/or friction load.</p> <p>The percentage value is a percentage of the nominal motor current (I0 of the PMAC MOTOR function block)</p> <p>This value cannot be higher than 150% of the drive rating.</p> <p>The default value of 10% is considered appropriate for most applications.</p>	0 to 200%	10%
55C65	STARTUP SPEED MOTOR2	<p>This parameter is used in conjunction with the ENABLE STARTUP parameter. It selects the speed setpoint at which the speed control is switched from an open loop mode to a closed loop mode during the startup procedure used for starting motors with a high inertia and/or friction load..</p> <p>The percentage value is a percentage of the maximum application speed (MAX SPEED of the REFERENCE function block )</p> <p>In open loop mode, the system is not controlled in speed mode. It must only be used to 'start' the motor under heavy conditions, or to transitorily reach the zero speed or crossing the zero speed setpoint. It is not intended to be used to control accurately a motion.</p>	0 to 100%	5%
SET::IPPA Menu				
5 IP01	AIMING POINT	Determines the final level of the inverse time current limit after a period of prolonged motor overload.	50 to 150%	105%
5 IP02	DELAY	Determines the maximum overload duration before inverse time current limit action is taken	5 to 60s	30s
5 IP03	DOWN TIME	Determines the rate at which the inverse time current limit is ramped down to the AIMING POINT after a period of prolonged overload.	1 to 10s	1s
5 IP04	UP TIME	Determines the rate at which the inverse time current limit is ramped back to the maximum current.	0.5 to 100s	1s
5 IP05	IT LIMITING	This diagnostic indicates if the drive protection is active.	0=FALSE 1=TRUE	
5 IP06	INV TIME OP	This diagnostic indicates the actual current level limit.	---%	
5 IP07	IT WARNING	This diagnostic indicates that the drive will reach its maximum overload level.	0=FALSE 1=TRUE	

MMI Parameters Table				
Display	Parameter	Description	Range	Default
<b>SET::I2P Menu</b>				
\$2P01	I2T INHIBIT	Inhibit/enable the action of the motor protection.	0=FALSE 1=TRUE	FALSE
\$2P02	I2T LIMIT MOTOR	This is diagnostic information: 0 : motor load level is lower than 100% 1 : motor load level is higher than 100%	0/1	
\$2P03	I2T LIMIT LOAD	This is a diagnostic information.  Indicates the percentage of motor load. This value is based on PERM CURRENT (permanent motor current). The time variation is based on THERMAL TIM CST	---%	
\$2P04	I2T MOTOR TRIP	State of the I2T trip, reported as MOTOR OVERTEMP: 0: the motor is running, the motor load level is lower than 100% 1: the motor is stopped; the motor load level is higher than 100%	0=FALSE 1=TRUE	
<b>SET::POL Menu</b>				
\$P001	POLARISATION	Set this parameter to enter the motor polarisation mode Clear it for standard SV control mode	0=FALSE 1=TRUE	
\$P002	POLAR START	Set this parameter to enable the motor polarisation mode Clear it to disable the motor polarisation mode	0=FALSE 1=TRUE	
\$P003	MOTOR PHASE	Select on which motor phases the motor polarisation is applied. When the motor polarisation is enabled, changing the motor phase allows to rotate the motor like a stepper motor. That gives the possibility to verify the correct motor phase connection to get a clockwise direction for a positive speed setpoint	0=U PHASE 1=V PHASE 2=W PHASE	
\$P004	CURRENT	This diagnostic gives the current setpoint applied to the motor during the motor polarisation mode.	---A	

## 6-26 Programming Your Application:

MMI Parameters Table				
Display	Parameter	Description	Range	Default
<b>PAR Menu</b>				
P 1	APPLICATION	This parameter selects and loads the Application to be used. APP 0 will not control a motor. APP 6, 7 & 8 are for future use. You can edit an Application in DSElite and, then set this parameter to CUSTOM to produce your own custom Application. Refer to the 650S Software Product Manual, Chapter 5: "Applications" which gives detailed information about each Application. <b>Note: Parameter values are changed to factory settings by loading a new Application, except Motor Parameters (indicated M)</b>	0= NULL 1= STANDARD 2= LOCAL/REM (AUTO/MANUAL) 3= PRESETS 4= RAISE/LOWER 5= PID 6= APP 6 7= APP 7 8= APP 8 9= CUSTOM	1
P 2	MAX SPEED M	The frequency at which the 650V will run when maximum setpoint is applied. The default is Product Code dependent	7.5 to 300Hz	50 or 60Hz
P 3	MIN SPEED	The minimum frequency at which the 650V will run, as a percentage of the MAX SPEED parameter	-100.0 to 100.0%	0.0%
P 4	ACCEL TIME	The time taken for the 650V output frequency to ramp up from zero to MAX SPEED	0.0 to 3000.0s	10.0s
P 5	DECEL TIME	The time taken for the 650V output frequency to ramp down from MAX SPEED to zero	0.0 to 3000.0s	10.0s
P 8	JOG SETPOINT	Speed the 650V will run at if the Jog input is high, as a percentage of the MAX SPEED parameter	-100.0 to 100.0%	10.0%
P 9	RUN STOP MODE	RAMPED : The motor speed is reduced to zero at a rate set by DECEL TIME (P5). A 2 second DC pulse is applied at end of ramp COAST : The motor is allowed to freewheel to a standstill DC INJECTION : On a stop command, the motor volts are rapidly reduced at constant frequency to deflux the motor. A low frequency braking current is then applied until the motor speed is almost zero. This is followed by a timed DC pulse to hold the motor shaft.	0=RAMPED 1=COAST 2=DC INJECTION	0
P 99	PASSWORD	A password may be set to prohibit unauthorised adjustment of parameters. When P99 is set to non-zero you will be required to match this value before parameters can be adjusted	0000 – FFFF	0000
<b>APP Menu</b>				
<b>Parameters visible when Application 3 is selected in parameter P1</b>				
AP01	PRESET 0	A user-adjustable speed preset, set by potentiometer	-100.00 to 100.00	-
AP02	PRESET 1	A user-adjustable speed preset	-100.00 to 100.00	20.00
AP03	PRESET 2	A user-adjustable speed preset	-100.00 to 100.00	50.00

MMI Parameters Table				
Display	Parameter	Description	Range	Default
AP04	PRESET 3	A user-adjustable speed preset	-100.00 to 100.00	100.00
AP05	PRESET 4	A user-adjustable speed preset	-100.00 to 100.00	-10.00
AP06	PRESET 5	A user-adjustable speed preset	-100.00 to 100.00	-20.00
AP07	PRESET 6	A user-adjustable speed preset	-100.00 to 100.00	-50.00
AP08	PRESET 7	A user-adjustable speed preset	-100.00 to 100.00	-100.00
<i>Parameters visible when Application 4 is selected in parameter P1</i>				
AP01	R/L RAMP TIME	The time taken to ramp the Raise/Lower output from 0.00% to 100.00% of its value	0.0 to 600.0s	10.0s
AP02	R/L MAX VALUE	The maximum value for the ramp output	-100.00 to 100.00%	100.00%
AP03	R/L MIN VALUE	The minimum value for the ramp output	-100.00 to 100.00%	0.00%
AP04	R/L RESET VALUE	The value the output is set to when Reset is TRUE, when DIN4 (terminal 10) is 24V in Application 4	-100.00 to 100.00%	0.00%
<i>Parameters visible when Application 5 is selected in parameter P1</i>				
AP01	PI P GAIN	The PI proportional gain	0.00 to 100.00	0.10
AP02	PI I GAIN	The PI integral gain	0.00 to 100.00	1.00
AP03	PID D GAIN	The PID derivative gain	0.00 to 100.00	0.00
AP04	PID D FILTER TC	In order to help attenuate high frequency noise on the derivative term, a first order lag has been provided. This parameter determines the filter time constant.	0.05 to 10.00s	0.05s
AP05	PID FEEDBACK GAIN	A multiplier applied to the feedback signal of the PID	-10.00 to 10.00	1.00
AP06	PID LIMIT	Determines the maximum positive and negative excursion (Limit) of the PID output	0.00 to 300.00%	300.00%
AP07	PID SCALING	This parameter represents an overall scaling factor which is applied after the PID positive and negative limit clamps	-3.0000 to 3.0000	1.0000
AP08	PID ERROR	The result of SETPOINT - FEEDBACK x FEEDBACK GAIN	—.xx %	—.xx%
AP09	PID OUTPUT	The output of the PID function block	—.xx %	—.xx %

## Configuring Terminals 9 & 10 (Digital Input/Output)

Terminal 10 can be operated as digital input DIN 4 or digital output DOUT2. It is configured via the keypad or ConfigEd Lite (or other suitable programming tool). The default for terminal 10 is to operate as a digital input, and the input logic is non-inverted.

Terminal 9 can be operated as digital input DIN3 or digital output DOUT1, however, it can only be configured via ConfigEd Lite (or other suitable programming tool). The default for terminal 9 is to operate as a digital input, and the input logic is non-inverted.

### Configure for use as a Digital Input (default)

For example, to use terminal 10 as an input, the output circuitry must be disabled by setting DOUT 2 SOURCE and DOUT 2 INVERT to zero. You can invert this logic using parameter DIN 4 INVERT.

Parameter	Setting
DOUT2 SOURCE	0
DOUT2 INVERT	0
DIN4 INVERT	Default is 0, setting to 1 inverts the input logic

## Configure for use as a Digital Output

For example, to use terminal 10 as an output, select DOUT 2 SOURCE to be 1, 2, 3, 4, 5 or 6. For instance, you could set parameter DOUT 2 SOURCE to 3 to have the output go high (24V) whenever the motor is running, operating an external relay or lamp. You can invert this logic using parameter DOUT 2 INVERT.

Parameter	Setting
DOUT2 SOURCE	<p><i>The output is high when:</i></p> <p>1 = HEALTH      The Run signal is not present, or no trip is active</p> <p>2 = TRIPPED      A trip is present</p> <p>3 = RUNNING      The motor is running</p> <p>4 = AT ZERO      The output frequency is below 1% of MAX SPEED (P2)</p> <p>5 = AT SPEED      The output frequency is at or near Setpoint and within <math>\pm 1\%</math> of MAX SPEED, set by (P2).</p> <p>6 = AT LOAD</p> <p>Always set DIN 4 INVERT to 0 if using Applications 1 and 5 – refer to Chapter 12.</p>
	DOUT2 INVERT      Default is 0, setting to 1 inverts the output logic



## PID - Tuning Your Drive

PID is used to control the response of any closed loop system. It is used specifically in system applications involving the control of drives to provide zero steady state error between Setpoint and Feedback, together with good transient performance.

### Proportional Gain (<sup>P</sup>AP01)

This is used to adjust the basic response of the closed loop control system. The PI error is multiplied by the Proportional Gain to produce an output.

### Integral (<sup>P</sup>AP02)

The Integral term is used to reduce steady state error between the setpoint and feedback values of the PI. If the integral is set to zero, then in most systems there will always be a steady state error.

### Derivative (<sup>P</sup>AP03)

This is used to correct for certain types of control loop instability, and therefore improve response. It is sometimes used when heavy or large inertia rolls are being controlled. The derivative term has an associated filter to suppress high frequency signals.

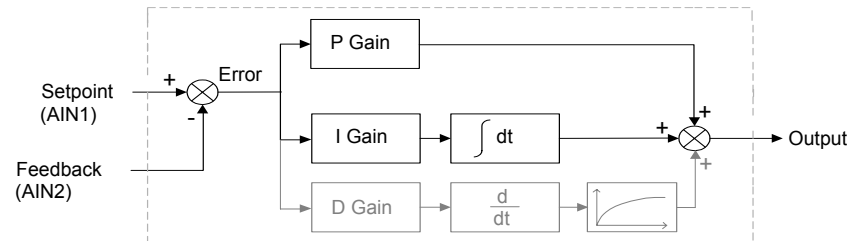

- Functions as P, PI, PID controller
- Single symmetric limit on output

### ***A Method for Setting-up the PI Gains***

The gains should be set-up so that a critically damped response is achieved for a step change in setpoint. An underdamped or oscillatory system can be thought of as having too much gain, and an overdamped system has too little.

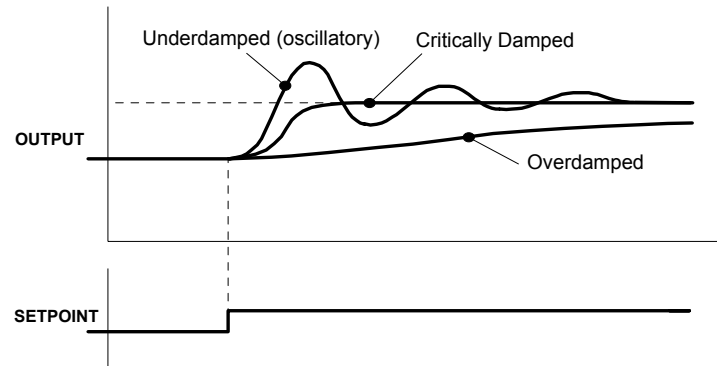

To set up the P gain, set the I gain to zero. Apply a step change in setpoint that is typical for the System, and observe the response. Increase the gain and repeat the test until the system becomes oscillatory. At this point, reduce the P gain until the oscillations disappear. This is the maximum value of P gain achievable.

If a steady state error is present, i.e. the feedback never reaches the setpoint value, the I gain needs to be increased. As before, increase the I gain and apply the step change. Monitor the output. If the output becomes oscillatory, reduce the P gain slightly. This should reduce the steady state error. Increasing the I gain further may reduce the time to achieve zero steady state error.

These values of P and I can now be adjusted to provide the exact response required for this step change.

## **Auto Restart**

Parameters <sup>S</sup>ST21 to <sup>S</sup>ST24 provide the facility to automatically reset a choice of trip events and restart the drive with a programmed number of attempts. If the drive is not successfully started, a manual or remote trip reset is required.

The number of attempted restarts are recorded. This count is cleared after a trip-free period of operation (5 minutes or 4 x AUTO RESTART DELAY, whichever is the longer); or after a successful manual or remote trip reset; or by removing the Run signal (Terminal 7, DIN1).

Refer to Chapter 7: "Trips and Fault Finding" - Hexadecimal Representation of Trips.

## Minimum Speed Mode

There are two operating modes for the minimum speed feature.

### Proportional with Minimum

In this mode the speed setpoint is clamped to be between the minimum speed value (P3) and 100%. This is the default for the minimum speed feature.

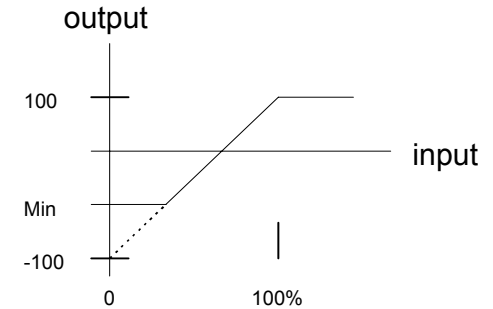

### Linear

In this mode the speed setpoint is first clamped to be in the range 0 to 100%. It is then rescaled so that the output goes linearly between the minimum speed value (P3) and 100% for an input setpoint that goes between 0% and 100%. If the minimum speed value (P3) is negative the speed setpoint will be internally set to 0%.

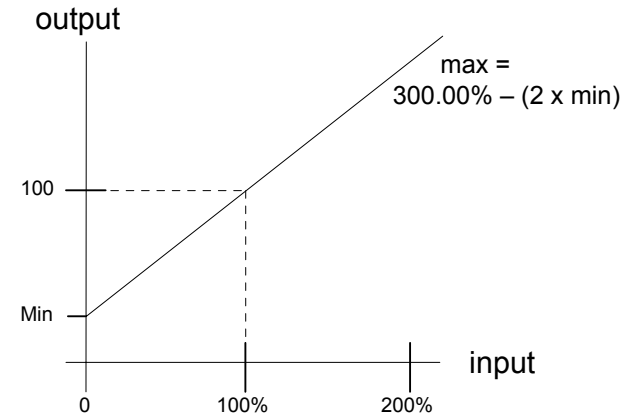

## Product-Related Default Values

All examples given in this book are based on a UK, 230V, 50Hz, 0.25kW drive. This manual provides information about each parameter accessible using the keypad, or MMI (Man Machine Interface). For more information about these and additional parameters accessible using ConfigEd Lite (or other suitable programming tool), refer to the 650S Software Product Manual on our web site: [www.SSDdrives.com](http://www.SSDdrives.com).

## \* Frequency Dependent Parameters

These parameter values (marked with “\*” in the Application diagrams) are dependent upon the drive’s "default frequency".

Changing the "default frequency" parameter from 50Hz to 60Hz, and vice versa, causes the values of the parameters in the table below to be changed.

To change the "default frequency", power-down the drive. Power-up the drive holding down the STOP and DOWN keys on the keypad. Release the keys to display the ° 0.01 parameter.

### Caution

You are now in a menu containing some sensitive and important parameters.

Press the UP key to display the ° 0.02 parameter. Press the M key. The values for this parameter are: 0 = 50Hz default, 1 = 60Hz default. Select the setting using the UP/DOWN keys and then press the E key. Power-down the drive and power-up again holding down the UP and DOWN keys. This resets **ALL** parameters to their correct default values, including Motor Parameters.

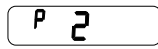
Frequency Dependent Defaults					
Display	Parameter	Function Block	Tag	50Hz Operation	60Hz Operation
	MAX SPEED	REFERENCE	57	250Hz	250Hz
# The correct value is selected for the size of drive - refer to the Power Dependent Parameters table below * The correct value is selected for the drive, however, when 60Hz is selected the 400V unit = 460V					

## \*\* Power Dependent Parameters

These parameters (marked with “\*\*” in the Application diagrams) are set to a value depending on the drive's overall “power-build” indicated by the Product Code. We recommend that you do not change the Product Code.

230V Build Power Dependent Defaults								
Parameter	Function Block	Tag	Frame 1				Frame 2	
			0.25kW	0.37kW	0.55kW	0.75kW	1.1kW	1.5kW
ACCEL TIME	REFERENCE RAMP	258	10.0 s	10.0 s	10.0 s	10.0 s	10.0 s	10.0 s
DECEL TIME	REFERENCE RAMP	259	10.0 s	10.0 s	10.0 s	10.0 s	10.0 s	10.0 s
SPEED PROP GAIN	SPEED LOOP	1187	20	20	20	20	20	20
SPEED INT TIME	SPEED LOOP	1188	500. ms	500. ms	500. ms	500. ms	500. ms	500. ms
BRAKE RESISTANCE	DYNAMIC BRAKING	77	500	500	500	500	500	500

400V Build Power Dependent Defaults								
Parameter	Function Block	Tag	Frame 2					
			0.37kW	0.55kW	0.75kW	1.1kW	1.5kW	2.2kW
ACCEL TIME	REFERENCE RAMP	258	10.0 s	10.0 s	10.0 s	10.0 s	10.0 s	10.0 s
DECEL TIME	REFERENCE RAMP	259	10.0 s	10.0 s	10.0 s	10.0 s	10.0 s	10.0 s
SPEED PROP GAIN	SPEED LOOP	1187	20	20	20	20	20	20
SPEED INT TIME	SPEED LOOP	1188	500. ms	500. ms	500. ms	500. ms	500. ms	500. ms
BRAKE RESISTANCE	DYNAMIC BRAKING	77	500	500	500	200	200	200

400V Build Power Dependent Defaults								
Parameter	Function Block	Tag	Frame 3					
ACCEL TIME	REFERENCE RAMP	258	10.0 s	10.0 s	10.0 s	10.0 s	10.0 s	10.0 s
DECEL TIME	REFERENCE RAMP	259	10.0 s	10.0 s	10.0 s	10.0 s	10.0 s	10.0 s
SPEED PROP GAIN	SPEED LOOP	1187	20	20	20	20	20	20
SPEED INT TIME	SPEED LOOP	1188	500. ms	500. ms	500. ms	500. ms	500. ms	500. ms
BRAKE RESISTANCE	DYNAMIC BRAKING	77	100	100	56	56	56	56

## **Chapter 7: Trips and Fault Finding**

The drive may trip in order to protect itself. To restart the drive, you will need to clear the trip(s). This chapter provides a list of trips, as displayed by the 6901, 6511, 6521 and 6911 keypads.

Trips .....	7-2
Using the Keypad to Manage Trips .....	7-3
Hexadecimal Representation of Trips .....	7-7
Fault Finding .....	7-10

# Trips

## Trip Warning Message

The trip display message is flashed repeatedly on the screen to warn of an imminent trip. Some trip conditions need time to take effect. The warning can allow you time to rectify the situation.

The message will clear when you use the keypad, but after a short time will reappear until the problem is resolved, or the drive trips.

## What Happens when a Trip Occurs

When a trip occurs, the drive's power stage is immediately disabled causing the motor and load to coast to a stop. The trip is latched until action is taken to reset it. This ensures that trips due to transient conditions are captured and the drive is disabled, even when the original cause of the trip is no longer present.

### Keypad Indications

If a trip condition is detected the activated alarm is displayed on the MMI display.

## Resetting a Trip Condition

All trips must be reset before the drive can be re-enabled. A trip can only be reset once the trip condition is no longer active, i.e. a trip due to a heatsink over-temperature will not reset until the temperature is below the trip level.

You can reset the trip as follows:





1. Press the  (STOP) key to reset the trip and clear the alarm from the display.
2. Remove and then re-apply the RUN command and the drive will run normally.

In remote mode, success is indicated by displaying **rdy**.

# Using the Keypad to Manage Trips







## Trip Messages

If the drive trips, then the display immediately shows a message indicating the reason for the trip. The possible trip messages are given in the table below.

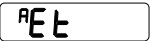
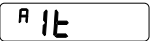
ID	Trip Name	Possible Reason for Trip
1	OVERVOLTAGE 	<i>The drive internal dc link voltage is too high:</i> <ul style="list-style-type: none"> <li>The supply voltage is too high</li> <li>Trying to decelerate a large inertia load too quickly; DECEL TIME time too short</li> <li>The brake resistor is open circuit</li> </ul>
2	UNDERVOLTAGE 	<i>DC link low trip:</i> Supply is too low/power down
3	OVERCURRENT 	<i>The motor current being drawn from the drive is too high:</i> <ul style="list-style-type: none"> <li>Trying to accelerate a large inertia load too quickly; ACCEL TIME time too short</li> <li>Trying to decelerate a large inertia load too quickly; DECEL TIME time too short</li> <li>Application of shock load to motor</li> <li>Short circuit between motor phases</li> <li>Short circuit between motor phase and earth</li> <li>Motor output cables too long</li> <li></li> </ul>
4	HEATSINK 	<i>Drive heatsink temperature &gt; 100°C:</i> <ul style="list-style-type: none"> <li>The ambient air temperature is too high</li> <li>Poor ventilation or spacing between drives</li> </ul>

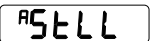

## 7-4 Trips and Fault Finding:

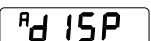
ID	Trip Name	Possible Reason for Trip
5	EXTERNAL TRIP 	<p><i>The external trip input is high:</i></p> <ul style="list-style-type: none"> <li>Check configuration to identify the source of the signal (non-standard configuration)</li> </ul>
6	INVERSE TIME 	<p><i>A prolonged overload condition, exceeding the Inverse Time allowance, has caused the trip:</i></p> <ul style="list-style-type: none"> <li>Remove the overload condition - refer to Chapter 5: P12</li> </ul>
7	CURRENT LOOP 	<p><i>A current of less than 1mA is present when 4-20mA setpoint is selected:</i></p> <ul style="list-style-type: none"> <li>Look for a wire break</li> </ul>
8	MOTOR STALLED 	<p><i>The motor has stalled (not rotating)</i></p> <ul style="list-style-type: none"> <li>SV trip validated, and speed lower than 5% of the maximum motor speed</li> <li>Too much friction to start rotating the motor</li> </ul>
9	ANIN FAULT 	<p><i>AIN2 overload on terminal 3:</i></p> <ul style="list-style-type: none"> <li>Overcurrent applied in Current mode to terminal 3</li> </ul>
10	BRAKE RESISTOR 	<p><i>External dynamic brake resistor has been overloaded:</i></p> <ul style="list-style-type: none"> <li>Trying to decelerate a large inertia too quickly or too often</li> </ul>
11	BRAKE SWITCH 	<p><i>Internal dynamic braking switch has been overloaded:</i></p> <ul style="list-style-type: none"> <li>Trying to decelerate a large inertia too quickly or too often</li> </ul>
12	DISPLAY/KEYPAD 	<p><i>Keypad has been disconnected from drive whilst drive is running in Local Control:</i></p> <ul style="list-style-type: none"> <li>Keypad accidentally disconnected from drive (indicated over Comms, or by second keypad)</li> </ul>

ID	Trip Name	Possible Reason for Trip
13	LOST COMMS R5C1	<i>Lost communications:</i> <ul style="list-style-type: none"> <li>• COMMS TIMEOUT parameter set too short</li> <li>• Master device failed</li> <li>• Wiring broken</li> <li>• Incorrect Comms setup</li> </ul>
14	CONTACTOR FBK R C N E C	<i>Contactor feedback signal lost:</i> <ul style="list-style-type: none"> <li>• Check connection to the terminal wired to "contactor closed" parameter in Sequencing Logic (non-standard configuration)</li> </ul>
15	SPEED FEEDBACK R SPd	<i>Speed feedback:</i> <ul style="list-style-type: none"> <li>• SPEED ERROR &gt; 50.00% for 10 seconds</li> </ul>
17	MOTOR OVERTEMP R O t	<i>The motor temperature is too high:</i> <ul style="list-style-type: none"> <li>• Excessive load ( Thermal switch )</li> <li>• Excessive load ( I2T software protection )</li> <li>• Motor voltage rating incorrect</li> <li>• Prolonged operation of the motor at low speed without forced cooling</li> <li>• Break in motor thermistor connection</li> </ul>
18	CURRENT LIMIT R I H I	<i>Software overcurrent trip:</i> <ul style="list-style-type: none"> <li>• If the current exceeds 180% of stack rated current for a period of 1 second, the drive will trip. This is caused by shock loads. Remove the shock load.</li> <li>• ACCEL TIME and/or FIXED BOOST set too high</li> <li>• DECEL TIME set too low</li> </ul>
21	LOW SPEED OVER I R L SPd	<ul style="list-style-type: none"> <li>• <i>The motor is drawing too much current (&gt; 100%) at zero output frequency</i></li> </ul>

## 7-6 Trips and Fault Finding:

ID	Trip Name	Possible Reason for Trip
22	10V FAULT A <sub>t</sub> 4	10V fault: <ul style="list-style-type: none"> <li>+10V REF overload warning (terminal 4) - 10mA maximum</li> </ul>
25	DC LINK RIPPLE A <sub>DCRP</sub>	The dc link ripple voltage is too high: <ul style="list-style-type: none"> <li>Check for a missing input phase</li> </ul>
27	OVERSPEED A <sub>OSPd</sub>	Overspeed: <ul style="list-style-type: none"> <li>&gt;150% base speed when in Sensorless Vector mode</li> </ul>
28	ANOUT FAULT A <sub>t</sub> 5	AOUT overload on terminal 5: <ul style="list-style-type: none"> <li>10mA maximum</li> </ul>
29	DIGIO 1 (T9) FAULT A <sub>t</sub> 9	DIN3 overload on terminal 9: <ul style="list-style-type: none"> <li>20mA maximum</li> </ul>
30	DIGIO 2 (T10) FAULT A <sub>t</sub> 10	DOUT2 overload on terminal 10: <ul style="list-style-type: none"> <li>50mA maximum</li> </ul>
31	UNKNOWN A <sub>EFIP</sub>	Unknown trip
32	OTHER A <sub>EF32</sub>	"OTHER" trip is active (Trip ID 34 to 44 inclusive)
-	Product Code Error A <sub>CODE</sub>	Switch unit off/on. If persistent, return unit to factory
-	Calibration Data Error A <sub>CAL</sub>	Switch unit off/on. If persistent, return unit to factory
-	Configuration Data Error A <sub>DATA</sub>	Press the <b>E</b> key to accept the default configuration. If persistent, return unit to factory

# Hexadecimal Representation of Trips

The tables below show the possible parameter values for the AUTO RESTART TRIGGERS and AUTO RESTART TRIGGERS+ parameters, <sup>S</sup>ST23 and <sup>S</sup>ST24 respectively. Refer to the 650S Software Product Manual, "Trips Status" (on our website: [www.SSDdrives.com](http://www.SSDdrives.com)) for additional trip information that is available over the Comms.

Each trip has a unique, four-digit hexadecimal number number as shown in the tables below.

<b><sup>S</sup>ST23 : AUTO RESTART TRIGGERS</b>				
ID	Trip Name (MMI 6901)	Trip Name (MMI 6511 & 6521)	Mask	User Disable
1	OVERVOLTAGE	DCHI	0x0001	
2	UNDERVOLTAGE	DCLO	0x0002	
3	OVERCURRENT	OC	0x0004	
4	HEATSINK	HOT	0x0008	
5	EXTERNAL TRIP	ET	0x0010	✓
6	INVERSE TIME	<sup>S</sup> I T	0x0020	✓
7	CURRENT LOOP	<sup>S</sup> L O O P	0x0040	✓
8	MOTOR STALLED	<sup>S</sup> S T L L	0x0080	✓
9	ANIN FAULT	<sup>S</sup> T 3	0x0100	✓
10	BRAKE RESISTOR	<sup>S</sup> d b r	0x0200	✓
11	BRAKE SWITCH	<sup>S</sup> d b S	0x0400	✓
12	DISPLAY/KEYPAD	<sup>S</sup> d i S P	0x0800	✓
13	LOST COMMS	SCI	0x1000	✓
14	CONTACTOR FBK	CNTC	0x2000	✓
15	SPEED FEEDBACK	<sup>S</sup> S P d	0x4000	✓

7-8 Trips and Fault Finding:

ST24 : AUTO RESTART TRIGGERS+				
ID	Trip Name (MMI 6901)	Trip Name (MMI 6511 & 6521)	Mask +	User Disable
17	MOTOR OVERTEMP	50t	0x0001	✓
18	CURRENT LIMIT	I HI	0x0002	
21	LOW SPEED OVER I	LSPD	0x0010	
22	10V FAULT	T 4	0x0020	✓
25	DC LINK RIPPLE	DCRP	0x0100	✓
27	OVERSPEED	50SPd	0x0400	✓
28	ANOUT FAULT	T 5	0x0800	✓
29	DIGIO 1 (T9) FAULT	T 9	0x1000	✓
30	DIGIO 2 (T10) FAULT	T 10	0x2000	✓
31	UNKNOWN	TRIP	0x4000	
32	OTHER	TR32	0x8000	
34	MAX SPEED LOW	ATN1	0x8000	N/A
35	MAIN VOLTS LOW	ATN2	0x8000	N/A
36	NOT AT SPEED	ATN3	0x8000	N/A
37	MAG CURRENT FAIL	ATN4	0x8000	N/A
38	NEGATIVE SLIP F	ATN5	0x8000	N/A
39	TR TOO LARGE	ATN6	0x8000	N/A
40	TR TOO SMALL	ATN7	0x8000	N/A
41	MAX RPM DATA ERR	ATN8	0x8000	N/A
42	MOTOR TURNING ERR	ATNA	0x8000	N/A
43	MOTOR STALL ERR	ATNB	0x8000	N/A
44	LEAKGE L TIMEOUT	ATN9	0x8000	N/A

## Keypads (MMIs):

Trips shown as MMI displays in the tables above, i.e.  , can be disabled using the keypads in the TRIPS menu. Other trips, as indicated, can be disabled over the Comms.



6901



6511



6521



6911

## Hexadecimal Representation of Trips

When more than one trip is to be represented at the same time then the trip codes are simply added together to form the value displayed. Within each digit, values between 10 and 15 are displayed as letters A to F

For example referring to the tables above, if the AUTO RESTART TRIGGERS parameter is set to **04A0**, then this represents:

a “4” in digit 3

an “8” and a “2” in digit 2  
(8+2 = 10, displayed as **A**)

an “0” in digit 1

Decimal number	Display
10	A
11	B
12	C
13	D
14	E
15	F

This in turn represents the trips BRAKE SWITCH, ANIN FAULT, MOTOR STALLED and INVERSE TIME.

In the same way, the AUTO RESTART TRIGGERS+ parameter set to **04A0** would represent OVERSPEED, ANIN FAULT, DESAT OVER I and 10V FAULT.

# Fault Finding

---

Problem	Possible Cause	Remedy
Drive will not power-up	Fuse blown	Check supply details, fit correct fuse. Check Product Code against Model Number.
	Faulty cabling	Check all connections are correct/secure. Check cable continuity.
Drive fuse keeps blowing	Faulty cabling or connections wrong	Check for problem and rectify before replacing with correct fuse.
	Faulty drive	Contact Parker SSD Drives.
Cannot obtain power-on state	Incorrect or no supply available	Check supply details.
Motor will not run at switch-on	Motor jammed	Stop the drive and clear the jam.
Motor runs and stops	Motor becomes jammed	Stop the drive and clear the jam.
	Open circuit speed reference potentiometer	Check terminal.

## Chapter 8: Routine Maintenance and Repair

The drive may trip in order to protect itself. To restart the drive, you will need to clear the trip(s). This chapter provides a list of trips, as displayed by the 6901, 6511, 6521 and 6911 keypads.

<b>Routine Maintenance</b> .....	<b>8-2</b>
<b>Repair</b> .....	<b>8-2</b>
Saving Your Application Data	8-2
Returning the Unit to Parker SSD Drives	8-2
Disposal	8-3



# Routine Maintenance

Periodically inspect the drive for build-up of dust or obstructions that may affect ventilation of the unit. Remove this using dry air.

# Repair

There are no user-serviceable components.

**IMPORTANT** *MAKE NO ATTEMPT TO REPAIR THE UNIT - RETURN IT TO PARKER SSD DRIVES.*

## Saving Your Application Data

In the event of a repair, application data will be saved whenever possible. However, we advise you to copy your application settings before returning the unit.

## Returning the Unit to Parker SSD Drives

Please have the following information available:

- The model and serial number - see the unit's rating label
- Details of the fault

Contact your nearest Parker SSD Drives Service Centre to arrange return of the item.

You will be given a *Returned Material Authorisation*. Use this as a reference on all paperwork you return with the faulty item. Pack and despatch the item in the original packing materials; or at least an anti-static enclosure. Do not allow packaging chips to enter the unit.

## Disposal

This product contains materials which are consignable waste under the Special Waste Regulations 1996 which complies with the EC Hazardous Waste Directive - Directive 91/689/EEC.

We recommend you dispose of the appropriate materials in accordance with the valid environmental control laws. The following table shows which materials can be recycled and which have to be disposed of in a special way.

Material	Recycle	Disposal
Metal	yes	no
plastics material	yes	no
printed circuit board	no	yes

The printed circuit board should be disposed of in one of two ways:

1. High temperature incineration (minimum temperature 1200°C) by an incinerator authorised under parts A or B of the Environmental Protection Act
2. Disposal in an engineered land fill site that is licensed to take aluminium electrolytic capacitors. Do not dispose of in a land fill site set aside for domestic waste.

## Packaging

During transport our products are protected by suitable packaging. This is entirely environmentally compatible and should be taken for central disposal as secondary raw material.

## 8-4 *Routine Maintenance and Repair:*

## Chapter 9: **Technical Specifications**

Understanding the Product Code.....	9-2
Environmental Details	9-3
Power Details	9-4
Electrical Ratings	9-5
User Relay	9-7
Analog Inputs/Outputs	9-7
Digital Inputs	9-8
Digital Outputs	9-8
Cabling Requirements for EMC Compliance	9-9
Internal Dynamic Braking Circuit	9-10
External Brake Resistor	9-11
Supply Harmonic Analysis (230V filtered)	9-13
Supply Harmonic Analysis (400V filtered)	9-14
Supply Harmonic Analysis (230V unfiltered)	9-15
Supply Harmonic Analysis (400V unfiltered)	9-16

# Understanding the Product Code

## Model Number

The unit is fully identified using a four block alphanumeric code which records how the drive was calibrated, and its various settings when despatched from the factory.

The Product Code appears as the “Model No.” on the product rating label. Each block of the Product Code is identified as below:

	Block 1	Block 2	Block 3	Block 4
Example:	650S	21140010	B01P00	A1
<b>Family</b>	650S Sensorless PMAC ( frames 1-3 )			650S
<b>Rating Data</b>	Supply Voltage	kW	Output Current	Frame Size
	230v 1ph			21
		0.75	4.0	1
		1.5	7.0	2
	400/460v 3ph			43
		0.75	2.5	2
		2.2	5.5	2
	4.0	9.0	3	
	7.5	16.0	3	2160 3
<b>Auxiliary supply</b>	Not required (Frames 1-3)			0
<b>Brake Switch</b>	Not Fitted (mandatory on Frame 1 & Frame 2 230V products)			0
	Brake switch fitted (mandatory on Frame 2 400V products & all Frame 3 & C products)			B
<b>Filter</b>	Not fitted (Optional on Frames 1-3)			0
	Filter fitted (Optional on Frames 1-3 only)			F
<b>Comms</b>	RS232 port fitted			1
<b>Mechanical style</b>	Panel Mount			P
<b>Special Option</b>	None			00
	Documented special options (01-99)			
<b>Destination</b>	English (50Hz)			A
<b>Keypad</b>	6511 TTL fitted (option on Frames 1-3 only)			1

<b>Environmental Details</b>	
<b>Operating Temperature</b>	0°C to 40°C  Output power is derated linearly at 2% per degree centigrade for temperature exceeding the maximum rating ambient of maximum 50°C
<b>Storage Temperature</b>	-25°C to +55°C
<b>Shipping Temperature</b>	-25°C to +70°C
<b>Product Enclosure Rating</b>	IP20 (UL Open Type) suitable for cubicle mount only
<b>Cubicle Rating</b>	Cubicle to provide 15dB attenuation to radiated emissions between 30-100MHz. It must also require a security tool for opening
<b>Altitude</b>	If >1000 metres (3300 feet) above sea level, derate Motor Power Rating by 1% per 100 metres (330 feet)
<b>Humidity</b>	Maximum 85% relative humidity at 40°C non-condensing
<b>Atmosphere</b>	Non flammable, non corrosive and dust free
<b>Climatic Conditions</b>	Class 3k3, as defined by EN50178
<b>Vibration</b>	Test Fc of EN60068-2-6  10Hz ≤ f ≤ 57Hz sinusoidal 0.075mm amplitude 57Hz ≤ f ≤ 150Hz sinusoidal 1g  10 sweep cycles per axis on each of three mutually perpendicular axis
<b>Safety</b>	
Pollution Degree Overvoltage Category	Pollution Degree II (non-conductive pollution, except for temporary condensation) Overvoltage Category III (numeral defining an impulse withstand level)

## 9-4 Technical Specifications:

<b>Power Details</b>	
<b>1-Phase Supply</b>	220-240V ac $\pm 10\%$ , 50/60Hz $\pm 10\%$ , ground referenced (TN) or non-ground referenced (IT)
<b>3-Phase Supply</b>	220-240V ac or 380-460V ac $\pm 10\%$ , 50/60Hz $\pm 10\%$ , ground referenced (TN) or non-ground referenced (IT) *
<b>Supply Power Factor (lag)</b>	0.9 (@ 50/60Hz)
<b>Output Frequency</b>	0 – 500Hz
<b>Overload</b>	150% for 30 seconds
<b>Supply Short Circuit Rating</b>	220-240V 1 $\phi$ product - 5000A, 220-240V ac 3 $\phi$ product - 7500A 380-460V 3 $\phi$ product - 10000A

\* An optional internal RFI filter offering full electromagnetic compatibility (EMC) for the majority of applications

# Electrical Ratings

Motor power, output current and input current must not be exceeded under steady state operating conditions.

Maximum Motor  $dv/dt = 10,000V/\mu s$ . This can be reduced by adding a motor choke in series with the motor. Contact Parker SSD Drives for recommended choke details.

Local wiring regulations always take precedence. Select cable rated for the drive.

The supply must be protected with a fuse (or Type B RCD) rated to the supply cable.

## FRAME 1 : 1-Phase (IT/TN), 230V

Drive Power (kW/hp)	Input Current @ 5kA		Output Current @ 40°C (A) ac	Maximum Power Loss (W)
	Surge Current peak/rms for 10ms (A)	(A)		
0.25/0.3	19/12	4.2	1.5	26
0.37/0.5	19/12	6.2	2.2	32
0.55/0.75	20/14	7.9	3.0	41
0.75/1.0	22/15	10.5	4.0	52

## FRAME 2 : 1-Phase (IT/TN), 230V

Drive Power (kW/hp)	Input Current @ 5kA		Output Current @ 40°C (A) ac	Maximum Power Loss (W)
	Surge Current peak/rms for 10ms (A)	(A)		
1.1/1.5	24/17	13.8	5.5	65
1.5/2.0	25/18	16.0	7.0	82

## FRAME 2 : 3-Phase (IT/TN), 400V

Drive Power (kW/hp)	Input Current @ 10kA (A)	Output Current @ 40°C (A) ac	Maximum Power Loss (W)
0.37/0.5	2.5	1.5	26
0.55/0.75	3.3	2.0	32
0.75/1.0	4.1	2.5	40
1.1/1.5	5.9	3.5	55
1.5/2.0	7.5	4.5	61
2.2/3.0	9.4	5.5	70



## Electrical Ratings

Motor power, output current and input current must not be exceeded under steady state operating conditions.

Maximum Motor dv/dt = 10,000V/μs. This can be reduced by adding a motor choke in series with the motor. Contact Parker SSD Drives for recommended choke details.

Local wiring regulations always take precedence. Select cable rated for the drive.

The supply must be protected with a fuse (or Type B RCD) rated to the supply cable.

### FRAME 3 : 1-Phase (IT/TN), 230V

Drive Power (kW/hp)	Input Current @ 7.5kA (A)	Output Current @ 40°C (A) ac	Maximum Power Loss (W)
2.2/3.0	22.0	9.6	112

### FRAME 3 : 3-Phase (IT/TN), 230V

Drive Power (kW/hp)	Input Current @ 7.5kA (A)	Output Current @ 40°C (A) ac	Maximum Power Loss (W)
2.2/3.0	14.3	9.6	103
3.0/4.0	18.1	12.3	133
4.0/5.0	23.1	16.4	180

### FRAME 3 : 3-Phase (IT/TN), 400V

Drive Power (kW/hp)	Input Current @ 10kA (A)	Output Current @ 40°C (A) ac	Maximum Power Loss (W)
3.0/4.0	11.1	6.8	80
4.0/5.0	13.9	9.0	100
5.5/7.5	18.0	12.0	136
7.5/10.0	23.6	16.0	180

<b>User Relay</b> RL1A, RL1B.	
Maximum Voltage	250Vac
Maximum Current	4A resistive load
Sample Interval	10ms

<b>Analog Inputs/Outputs</b> AIN1, AIN2, AOUT.		
	Inputs	Output
Range	0-10V and 0-5V (no sign) set via parameter <sup>s</sup> IP13 (AIN1) 0-10V, 0-5V, 0-20mA or 4-20mA (no sign) set via parameter <sup>s</sup> IP23 (AIN2) Absolute maximum input current 25mA in current mode Absolute maximum input voltage 24V dc in voltage mode	0-10V (no sign) Maximum rated output current 10mA, with short circuit protection
Impedance	Voltage input 20k $\Omega$ Current Input <6V @ 20mA	
Resolution	10 bits (1 in 1024)	10 bits (1 in 1024)
Dynamic Response	Sampled every 10ms	Bandwidth 15Hz

9-8 *Technical Specifications:*

<h2>Digital Inputs</h2>	
<b>Operating Range</b>	<p>DIN1, DIN2, DIN3, DIN4, DIN5:            0-5V dc = OFF, 15-24V dc = ON            (absolute maximum input voltage <math>\pm 30V</math> dc)            IEC1131</p> <p>DIN6, DIN7:            0-1.5V dc = OFF, 4-24V dc = ON            (absolute maximum input voltage <math>\pm 30V</math> dc)            IEC1131</p>
<b>Input Current</b>	7.5mA @ 24V
<b>Sample Interval</b>	10ms

<h2>Digital Outputs</h2>	
<p>DOUT1 and DOUT2 (DOUT1 is only configurable using ConfigEd Lite or other suitable programming tool).</p>	
<b>Nominal Open Circuit Output Voltage</b>	23V (minimum 19V)
<b>Nominal Output Impedance</b>	33 $\Omega$
<b>Rated Output Current</b>	50mA

<b>Cabling Requirements for EMC Compliance</b>				
	<b>Power Supply Cable</b>	<b>Motor Cable</b>	<b>Brake Resistor Cable</b>	<b>Signal/Control Cable</b>
<b>Cable Type (for EMC Compliance)</b>	Unscreened	Screened/armoured	Screened/armoured	Screened
<b>Segregation</b>	From all other wiring (clean)	From all other wiring (noisy)		From all other wiring (sensitive)
<b>Length Limitations With Internal AC Supply EMC Filter</b>	Unlimited	*25 metres	25 metres	25 metres
<b>Length Limitations Without Internal AC Supply EMC Filter</b>	Unlimited	25 metres	25 metres	25 metres
<b>Screen to Earth Connection</b>		Both ends	Both ends	Drive end only
<b>Output Choke</b>		300 metres maximum		
* Maximum motor cable length under any circumstances				

<b>Internal Dynamic Braking Circuit</b>				
The dynamic braking circuit is intended for with short term stopping or braking.				
Motor Power (kW/Hp)	Brake Switch Peak Current (A)	Brake Switch Continuous Current (A)	Peak Brake Dissipation (kW/Hp)	Minimum Brake Resistor Value (Ω)
<b>Frame 2 : 3 Phase (IT/TN), 400V, 100% duty</b> DC link brake voltage : 750V				
0.37/0.5	1.5	1.5	1.1/1.5	500
0.55/0.75	1.5	1.5	1.1/1.5	500
0.75/1.0	1.5	1.5	1.1/1.5	500
1.1/1.5	1.5	1.5	1.1/1.5	500
1.5/2.0	3.75	3.75	2.8/3.75	200
2.2/3.0	3.75	3.75	2.8/3.75	200
<b>Frame 3 : 1 Phase (IT/TN), 230V, 100% duty</b>				
2.2/3.0	7.0	7.0	2.72	56
<b>Frame 3 : 3 Phase (IT/TN), 230V, 100% duty</b> DC link brake voltage : 390V				
2.2/3.0	7.0	7.0	2.72	56
3.0/4	10.8	10.8	4.23	36
4.0/5	14.0	14.0	5.44	28
<b>Frame 3 : 3 Phase (IT/TN), 400V, 30% duty</b> DC link brake voltage : 750V				
3.0/4	7.5	2.3	5.6/7.5	100
4.0/5	7.5	2.3	5.6/7.5	100
5.5/7.5	13.5	4.0	10/13.4	56
7.5/10	13.5	4.0	10/13.4	56

## External Brake Resistor

All 650S units are supplied without braking resistors. The dynamic brake switch terminals (where fitted) allow easy connection to an external resistor. These resistors should be mounted on a heatsink (back panel) and covered to prevent injury from burning.

### Recommended Brake Resistors

The following brake resistors are available from Parker SSD Drives:

Brake Resistor Value : Frame 2 : 200Ω, 100W - CZ467714; 500Ω, 60W - CZ467715  
 Frame 3 : 28Ω, 500W (2 x 56Ω in parallel) - CZ467716; 36Ω, 500W - CZ388396;  
 56Ω, 500W - CZ467716; 100Ω, 200W - CZ467717

### Alternative Brake Resistor Selection

Brake resistor assemblies must be rated to absorb both peak braking power during deceleration and the average power over the repeated cycles.

$$\text{Peak braking power } P_{pk} = \frac{0.0055 \times J \times (n_1^2 - n_2^2)}{t_b} \quad (\text{W})$$

$$\text{Average braking power } P_{av} = \frac{P_{pk}}{t_c} \times t_b$$

- J - total inertia (kgm<sup>2</sup>)
- n<sub>1</sub> - initial speed (rpm)
- n<sub>2</sub> - final speed (rpm)
- t<sub>b</sub> - braking time (s)
- t<sub>c</sub> - cycle time (s)

## 9-12 Technical Specifications:

Obtain information on the peak power rating and the average power rating of the resistors from the resistor manufacturer. If this information is not available, a large safety margin must be incorporated to ensure that the resistors are not overloaded. By connecting these resistors in series and in parallel the braking capacity can be selected for the application.

**IMPORTANT:** *The minimum resistance of the combination and maximum dc link voltage must be as specified.*

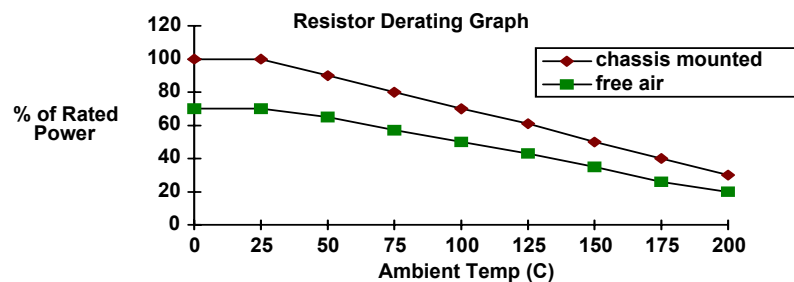

### Supply Harmonic Analysis (230V filtered)

Assumptions: (Short circuit fault to Neutral)  
 5kA short circuit supply capability at 230V 1φ, equivalent to 146μH supply impedance  
 7.5kA short circuit supply capability at 230V 3φ, equivalent to 56μH supply impedance  
 10kA short circuit supply capability at 400V 3φ, equivalent to 73μH supply impedance

$$THD(V) \times 100 = \frac{\sqrt{\sum_{h=2}^{h=40} Q_h^2}}{Q_{1n}} \%$$

where  $Q_{1n}$  is the rated rms value of the fundamental voltage of the supply transformer.  
 The results conform to stage 1 and stage 2 of the Engineering Recommendation G.5/4 February 2001,  
 Classification 'C': Limits for Harmonics in the UK Electricity Industry.

Drive Type	650S								
Motor Power (kW)	0.25	0.37	0.55	0.75	1.1	1.5	2.2	3.0	4.0
Fundamental Voltage (V)	230	230	230	230	230	230	230	230	230
Typical Motor Efficiency %	85	85	85	85	85	85	85	85	85
Harmonic No.	RMS Current (A)								
1	7.4	7.5	7.8	8.2	9.0	10.3	TBA	TBA	TBA
3	1.4	0.2	1.9	2.2	2.9	3.9			
5	2.9	0.4	4.4	4.6	4.8	5.2			
7	1.1	0.5	1.9	2.0	2.3	2.5			
9	0.2	0.2	0.2	0.3	0.4	0.4			
11	0.1	0.1	0.2	0.2	0.2	0.3			
13	0.0	0.1	0.1	0.1	0.1	0.1			
15	0.1	0.0	0.1	0.1	0.1	0.1			
17	0.0	0.1	0.0	0.0	0.0	0.1			
19	0.0	0.0	0.0	0.0	0.0	0.1			
21	0.0	0.0	0.0	0.0	0.0	0.1			
23	0.0	0.0	0.0	0.0	0.0	0.0			
25	0.0	0.0	0.0	0.0	0.0	0.0			
27	0.0	0.0	0.0	0.0	0.0	0.0			
29	0.0	0.0	0.0	0.0	0.0	0.0			
31	0.0	0.0	0.0	0.0	0.0	0.0			
33	0.0	0.0	0.0	0.0	0.0	0.0			
35	0.0	0.0	0.0	0.0	0.0	0.0			
37	0.0	0.0	0.0	0.0	0.0	0.0			
39	0.0	0.0	0.0	0.0	0.0	0.0			
40	0.0	0.0	0.0	0.0	0.0	0.0			
Total RMS Current (A)	8.2	7.5	9.3	9.9	10.9	12.5			
THD (V) %	0.3559	0.0972	0.5426	0.5733	0.6277	0.7055			



## 9-14 Technical Specifications:

### Supply Harmonic Analysis (400V filtered)

Assumptions: (Short circuit fault to Neutral)

5kA short circuit supply capability at 230V 1 $\phi$ , equivalent to 146 $\mu$ H supply impedance

7.5kA short circuit supply capability at 230V 3 $\phi$ , equivalent to 56 $\mu$ H supply impedance

10kA short circuit supply capability at 400V 3 $\phi$ , equivalent to 73 $\mu$ H supply impedance

$$THD(V) \times 100 = \sqrt{\frac{\sum_{h=40}^{h=2} Q_{h^2}}{Q_{1n}}} \%$$

where  $Q_{1n}$  is the rated rms value of the fundamental voltage of the supply transformer.

The results conform to stage 1 and stage 2 of the Engineering Recommendation G.5/4 February 2001,

Classification 'C': Limits for Harmonics in the UK Electricity Industry.

Drive Type	650S									
Motor Power (kW)	0.37	0.55	0.75	1.1	1.5	2.2	3.0	4.0	5.5	7.5
Fundamental Voltage (V)	400	400	400	400	400	400	400	400	400	400
Typical Motor Efficiency %	85	85	85	85	85	85	85	85	85	85
Harmonic No.	RMS Current (A)									
1	0.6	1.0	1.3	1.9	2.6	3.8	5.2	6.9	9.5	12.9
3	0.0	0.0	0.0	0.0	0.0	0.0	0.0	0.0	0.0	0.0
5	0.6	0.9	1.2	1.8	2.4	3.5	4.7	6.2	8.3	11.1
7	0.6	0.9	1.2	1.7	2.3	3.3	4.3	5.5	7.3	9.5
9	0.0	0.0	0.0	0.0	0.0	0.0	0.0	0.0	0.0	0.0
11	0.5	0.8	1.0	1.5	1.9	2.6	3.3	3.9	4.8	5.7
13	0.0	0.7	0.9	1.3	1.6	2.2	2.7	3.0	3.5	3.9
15	0.4	0.0	0.0	0.0	0.0	0.0	0.0	0.0	0.0	0.0
17	0.4	0.6	0.7	1.0	1.1	1.4	1.6	1.5	1.4	1.2
19	0.0	0.5	0.6	0.9	0.9	1.1	1.1	0.9	0.8	0.7
21	0.3	0.0	0.0	0.0	0.0	0.0	0.0	0.0	0.0	0.0
23	0.2	0.3	0.4	0.6	0.5	0.5	0.4	0.3	0.5	0.7
25	0.0	0.3	0.3	0.4	0.3	0.3	0.2	0.4	0.5	0.7
27	0.1	0.0	0.0	0.0	0.0	0.0	0.0	0.0	0.0	0.0
29	0.1	0.2	0.2	0.2	0.1	0.2	0.3	0.4	0.4	0.4
31	0.0	0.1	0.1	0.1	0.1	0.2	0.3	0.3	0.3	0.3
33	0.1	0.0	0.0	0.0	0.0	0.0	0.0	0.0	0.0	0.0
35	0.0	0.1	0.1	0.1	0.1	0.2	0.2	0.2	0.2	0.3
37	0.0	0.1	0.1	0.1	0.1	0.2	0.1	0.1	0.2	0.3
39	0.0	0.0	0.0	0.0	0.0	0.0	0.0	0.0	0.0	0.0
40	0.0	0.0	0.0	0.0	0.0	0.0	0.0	0.0	0.0	0.0
Total RMS Current (A)	1.4	2.1	2.8	4.0	5.1	7.2	9.5	12.0	15.8	20.8
THD (V) %	0.1561	0.2158	0.2776	0.3859	0.4393	0.5745	0.6994	0.8111	0.9899	1.2110

### Supply Harmonic Analysis (230V unfiltered)

Assumptions: (Short circuit fault to Neutral)  
 5kA short circuit supply capability at 230V 1 $\phi$ , equivalent to 146 $\mu$ H supply impedance  
 7.5kA short circuit supply capability at 230V 3 $\phi$ , equivalent to 56 $\mu$ H supply impedance  
 10kA short circuit supply capability at 400V 3 $\phi$ , equivalent to 73 $\mu$ H supply impedance

$$THD(V) \times 100 = \frac{\sqrt{\sum_{h=2}^{h=40} Q_h^2}}{Q_{1n}} \%$$

where  $Q_{1n}$  is the rated rms value of the fundamental voltage of the supply transformer.

The results conform to stage 1, stage 2 and stage 3 of the Engineering Recommendation G.5/3 September 1976, Classification 'C': Limits for Harmonics in the UK Electricity Industry.

Drive Type	650S								
Motor Power (kW)	0.25	0.37	0.55	0.75	1.1	1.5	2.2	3.0	4.0
Fundamental Voltage (V)	230	230	230	230	230	230	230	230	230
Typical Motor Efficiency %	85	85	85	85	85	85	85	85	85
Harmonic No.	RMS Current (A)								
1	1.3	2.0	2.9	3.9	5.7	7.8	TBA	TBA	TBA
3	1.3	1.9	2.9	3.8	5.5	7.4			
5	1.2	1.9	2.7	3.5	5.0	6.7			
7	1.1	1.7	2.5	3.1	4.4	5.4			
9	1.1	1.6	2.2	2.7	3.7	4.6			
11	1.0	1.4	1.9	2.2	2.9	3.4			
13	0.8	1.2	1.6	1.6	2.1	2.3			
15	0.7	1.0	1.3	1.2	1.4	1.4			
17	0.6	0.8	1.0	0.8	0.8	0.7			
19	0.5	0.7	0.7	0.4	0.4	0.3			
21	0.4	0.5	0.5	0.2	0.2	0.4			
23	0.3	0.3	0.3	0.2	0.3	0.4			
25	0.2	0.2	0.1	0.2	0.3	0.4			
27	0.1	0.1	0.1	0.2	0.3	0.3			
29	0.1	0.1	0.1	0.2	0.2	0.2			
31	0.0	0.1	0.1	0.1	0.1	0.1			
33	0.0	0.1	0.1	0.1	0.1	0.2			
35	0.0	0.1	0.1	0.1	0.1	0.2			
37	0.1	0.1	0.1	0.1	0.1	0.1			
39	0.0	0.1	0.1	0.1	0.1	0.1			
40	0.0	0.0	0.0	0.0	0.0	0.0			
Total RMS Current (A)	3.2	4.8	6.7	8.3	11.7	15.3			
THD (V) %	0.5633	0.8016	1.0340	1.0944	1.4611	1.7778			

## 9-16 Technical Specifications:

### Supply Harmonic Analysis (400V unfiltered)

Assumptions: (Short circuit fault to Neutral)

5kA short circuit supply capability at 230V 1 $\phi$ , equivalent to 146 $\mu$ H supply impedance

7.5kA short circuit supply capability at 230V 3 $\phi$ , equivalent to 56 $\mu$ H supply impedance

10kA short circuit supply capability at 400V 3 $\phi$ , equivalent to 73 $\mu$ H supply impedance

$$THD(V) \times 100 = \frac{\sqrt{\sum_{h=2}^{h=40} Q_{h^2}}}{Q_{1n}} \%$$

where  $Q_{1n}$  is the rated rms value of the fundamental voltage of the supply transformer.

The results conform to stage 1, stage 2 and stage 3 of the Engineering Recommendation G.5/3 September 1976, Classification 'C': Limits for Harmonics in the UK Electricity Industry.

Drive Type	650S									
Motor Power (kW)	0.37	0.55	0.75	1.1	1.5	2.2	3.0	4.0	5.5	7.5
Fundamental Voltage (V)	400	400	400	400	400	400	400	400	400	400
Typical Motor Efficiency %	85	85	85	85	85	85	85	85	85	85
Harmonic No.	RMS Current (A)									
1	0.6	0.9	1.3	1.9	2.6	3.8	5.2	6.9	9.5	12.7
3	0.0	0.0	0.0	0.0	0.0	0.0	0.0	0.0	0.0	0.0
5	0.6	0.9	1.2	1.8	2.4	3.6	4.7	6.3	8.4	11.0
7	0.6	0.9	1.2	1.7	2.3	3.3	4.3	5.7	7.4	9.5
9	0.0	0.0	0.0	0.0	0.0	0.0	0.0	0.0	0.0	0.0
11	0.5	0.8	1.0	1.5	1.9	2.6	3.3	4.2	4.9	5.8
13	0.5	0.7	0.9	1.3	1.6	2.2	2.7	3.4	3.7	4.0
15	0.0	0.0	0.0	0.0	0.0	0.0	0.0	0.0	0.0	0.0
17	0.4	0.6	0.7	0.9	1.2	1.5	1.6	1.9	1.5	1.3
19	0.4	0.5	0.6	0.8	0.9	1.1	1.1	1.3	0.8	0.7
21	0.0	0.0	0.0	0.0	0.0	0.0	0.0	0.0	0.0	0.0
23	0.3	0.4	0.4	0.5	0.5	0.5	0.4	0.4	0.5	0.7
25	0.2	0.3	0.3	0.3	0.4	0.3	0.2	0.3	0.5	0.7
27	0.0	0.0	0.0	0.0	0.0	0.0	0.0	0.0	0.0	0.0
29	0.1	0.2	0.2	0.2	0.1	0.2	0.2	0.3	0.4	0.4
31	0.1	0.1	0.1	0.1	0.1	0.2	0.3	0.3	0.3	0.3
33	0.0	0.0	0.0	0.0	0.0	0.0	0.0	0.0	0.0	0.0
35	0.1	0.1	0.1	0.1	0.1	0.2	0.2	0.2	0.2	0.3
37	0.0	0.1	0.1	0.1	0.1	0.2	0.2	0.1	0.2	0.2
39	0.0	0.0	0.0	0.0	0.0	0.0	0.0	0.0	0.0	0.0
40	0.0	0.0	0.0	0.0	0.0	0.0	0.0	0.0	0.0	0.0
Total RMS Current (A)	1.5	2.1	2.8	4.0	5.1	7.4	9.5	12.4	16.0	20.6
THD (V) %	0.1634	0.2209	0.2817	0.3569	0.4444	0.5886	0.7107	0.8896	1.0127	1.2138

## Chapter 10: **Certification for the Drive**

This Chapter outlines the additional steps that may be required to achieve EMC conformance.

<b>Requirements for EMC Compliance .....</b>	<b>10-2</b>
Earthing Requirements	10-2
<b>Requirements for UL Compliance .....</b>	<b>10-3</b>
<b>European Directives and the CE Mark.....</b>	<b>10-6</b>
CE Marking for Low Voltage Directive	10-6
CE Marking for EMC - Who is Responsible?	10-6
<b>EMC Compliance.....</b>	<b>10-7</b>
Certificates	10-8

# Requirements for EMC Compliance

---

## Earthing Requirements

**IMPORTANT:** *Protective earthing always takes precedence over EMC earthing.*

### Protective Earth (PE) Connections

**Note:** In accordance with installations to EN60204, only one protective earth conductor is permitted at each protective earth terminal contacting point.

Local wiring regulations may require the protective earth connection of the motor to be connected locally, i.e. not as specified in these instructions. This will not cause shielding problems because of the relatively high RF impedance of the local earth connection.

### EMC Earth Connections

For compliance with EMC requirements, the “0V/signal ground” is to be separately earthed. When a number of units are used in a system, these terminals should be connected together at a single, local earthing point.

Control and signal cables connections should be made with screened cables, with the screen connected only at the VSD end. However, if high frequency noise is still a problem, earth screen at the non VSD end via a 0.1 $\mu$ F capacitor.

**Note:** Connect the screen (at the VSD end) to the VSD protective earth point , and not to the control board terminals.

# Requirements for UL Compliance

---

## Solid-State Motor Overload Protection

These devices provide Class 10 motor overload protection. The maximum internal overload protection level (current limit) is 150% for 30 seconds.

An external motor overload protective device must be provided by the installer where the motor has a full-load ampere rating of less than 50% of the drive output rating.

## Short Circuit Rating

The following drives are suitable for use on a circuit capable of delivering not more than:

- 220-240V product, 1 $\phi$  - 5000 RMS Symmetrical Amperes
- 220-240V product, 3 $\phi$  - 7500 RMS Symmetrical Amperes
- 380-460V product, 3 $\phi$  - 10000 RMS Symmetrical Amperes

## Solid-State Short-Circuit Protection

These devices are provided with Solid-State Short-Circuit (output) Protection. Branch circuit protection requirements must be in accordance with the latest edition of the National Electrical Code NEC/NFPA-70.

## Recommended Branch Circuit Protection

It is recommended that UL Listed (JDDZ) non-renewable cartridge fuses, Class K5 or H; or UL Listed (JDRX) renewable cartridge fuses, Class H, are installed upstream of the drive.

## Motor Base Frequency

The motor base frequency rating is 500Hz maximum.

## Field Wiring Temperature Rating

Use 75°C Copper conductors only.

## 10-4 Certification for the Drive

### **Field Wiring Terminal Markings**

For correct field wiring connections that are to be made to each terminal refer to Chapter 3: “Installing the Drive”.

### **Terminal Tightening Torque**

Refer to Chapter 3: “Installing the Drive” – Terminal Tightening Torque.

### **Terminal/Wire Sizes**

North American wire sizes (AWG) are based on NEC/NFPA-70 for ampacities of thermoplastic-insulated (75°C) copper conductors.

Power input and output wire sizes should allow for an ampacity of 125% of the rated input and output amperes for motor branch-circuit conductors as specified in NEC/NFPA-70. Refer to Chapter 3: “Installing the Drive” – Terminal Block Acceptance Sizes.

### **Field Grounding Terminals**

The field grounding terminals are identified with the International Grounding Symbol  (IEC Publication 417, Symbol 5019).

### **Operating Ambient Temperature**

Devices are considered acceptable for use in a maximum ambient temperature of 40°C (can be derated up to 50°C, see page 9-3 “Operating Temperature”).

## Input Fuse Ratings

If fitted, fuses should be in accordance with NEC/NFPA-70.

<b>FRAME 1 : 1-Phase (IT/TN), 230V</b>		
Drive Power (kW/hp)	Input Current @ 5kA (A)	Supply Fuse Rating (A) 10 x 38mm
0.25/0.3	4.2	10
0.37/0.5	6.2	10
0.55/0.75	7.9	10
0.75/1.0	10.5	15
<b>FRAME 2 : 1-Phase (IT/TN), 230V</b>		
Drive Power (kW/hp)	Input Current @ 5kA (A)	Supply Fuse Rating (A) 10 x 38mm
1.1/1.5	13.8	20
1.5/2.0	16.0	20
<b>FRAME 2 : 3-Phase (IT/TN), 400V</b>		
Drive Power (kW/hp)	Input Current @ 10kA (A)	Supply Fuse Rating (A) 10 x 38mm
0.37/0.5	2.5	10
0.55/0.75	3.3	10
0.75/1.0	4.1	10
1.1/1.5	5.9	10
1.5/2.0	7.5	10
2.2/3.0	9.4	15
<b>FRAME 3 : 1-Phase (IT/TN), 230V</b>		
Drive Power (kW/hp)	Input Current @ 7.5kA (A)	Supply Fuse Rating (A) 10 x 38mm
2.2/3.0	22.0	30
<b>FRAME 3 : 3-Phase (IT/TN), 230V</b>		
Drive Power (kW/hp)	Input Current @ 7.5kA (A)	Supply Fuse Rating (A) 10 x 38mm
2.2/3.0	14.3	15
3.0/4.0	18.1	20
4.0/5.0	23.1	25
<b>FRAME 3 : 3-Phase (IT/TN), 400V</b>		
Drive Power (kW/hp)	Input Current @ 10kA (A)	Supply Fuse Rating (A) 10 x 38mm
3.0/4	11.1	15
4.0/5	13.9	20
5.5/7.5	18.0	25
7.5/10	23.6	30



# European Directives and the CE Mark

---

## CE Marking for Low Voltage Directive

When installed in accordance with this manual, the 650S AC Drive is CE marked by Parker Hannifin Ltd, Automation Group, SSD Drives Europe, in accordance with the low voltage directive (S.I. No. 3260 implements this LVD directive into UK law). An EC Declaration of Conformity (low voltage directive) is included at the end of this chapter.

## CE Marking for EMC - Who is Responsible?

**Note:** The specified EMC emission and immunity performance of this unit can only be achieved when the unit is installed to the EMC Installation Instructions given in this manual.

According to S.I. No. 2373 which implements the EMC directive into UK law, the requirement for CE marking this unit falls into two categories:

1. Where the supplied unit has an intrinsic/direct function to the end user, then the unit is classed as *relevant apparatus*. In this situation the responsibility for certification rests with Parker Hannifin Ltd, Automation Group, SSD Drives Europe. The Declaration of Conformity is included at the end of this Chapter.
2. Where the supplied unit is incorporated into a higher system/apparatus or machine which includes (at least) the motor, cable and a driven load but is unable to function without this unit, then the unit is classed as a *component*. In this circumstance, the responsibility rests with the manufacturer/supplier/installer of the system/apparatus/machine.

# EMC Compliance

---

<b>All Models</b>	
All models are compliant with BS EN61800-3.	
<b>Radiated Emissions</b>	EN61000-6-3 and EN61800-3 unrestricted distribution when mounted inside the specified cubicle, see above. Control and motor cables must be screened and correctly fitted with glands where they exit the cubicle. Control 0V must be connected to protective earth/ground.
<b>Immunity</b>	EN61800-3, EN61000-6-2
<b>FRAME 1 &amp; 2: 1-Phase (TN only),</b>	
<b>Conducted Emissions</b>	EN61000-6-3, EN61800-3 unrestricted distribution, maximum motor cable length: 25m
<b>FRAME 2 &amp; 3 : 3-Phase, FRAME 3 : 1-Phase (TN only)</b>	
<b>Conducted Emissions</b>	EN61000-6-4, EN61800-3 restricted distribution maximum motor cable length: 25m

# Certificates

Issued for compliance with the EMC Directive when the unit is used as *relevant apparatus*.

This is provided to aid your justification for EMC compliance when the unit is used as a component.

<b>650S 0.25 – 2.0kW 230V</b>	
<b>CE</b>	
<b>EC DECLARATIONS OF CONFORMITY</b>	
Date CE marked first applied: 19/10/2009	
<p><b>EMC Directive</b></p> <p>In accordance with the EEC Directive 2004/108/EC</p> <p>We Parker Hannifin Ltd., Automation Group, SSD Drives Europe, address as below, declare under our sole responsibility that the above Electronic Products when installed and operated with reference to the instructions in the Product Manual (provided with each piece of equipment) is in accordance with the relevant clauses from the following standard:-</p> <p style="text-align: center;">BSEN61800-3 (2004)</p>	<p><b>Low Voltage Directive</b></p> <p>In accordance with the EEC Directive 2006/95/EC</p> <p>We Parker Hannifin Ltd., Automation Group, SSD Drives Europe, address as below, declare under our sole responsibility that the above Electronic Products when installed and operated with reference to the instructions in the Product Manual (provided with each piece of equipment), is in accordance with the following standard :-</p> <p style="text-align: center;">EN50178 (1998)</p>
<b>MANUFACTURERS DECLARATIONS</b>	
<p><b>EMC Declaration</b></p> <p>We Parker Hannifin Ltd., Automation Group, SSD Drives Europe, address as below, declare under our sole responsibility that the above Electronic Products when installed and operated with reference to the instructions in the Product Manual (provided with each piece of equipment) is in accordance with the relevant clauses from the following standard:-</p> <p style="text-align: center;">BSEN61800-3 (2004)</p>	<p><b>Machinery Directive</b></p> <p>The above Electronic Products are components to be incorporated into machinery and may not be operated alone. The complete machinery or installation using this equipment may only be put into service when the safety considerations of the Directive 2006/42/EC are fully adhered to. Particular reference should be made to EN60204-1 (Safety of Machinery - Electrical Equipment of Machines). All instructions, warnings and safety information of the Product Manual must be adhered to.</p>
 <hr style="width: 20%; margin: auto;"/> <p style="text-align: center;">Dr Martin Payn (Conformance Officer)</p>	
<p><b>PARKER HANNIFIN LIMITED, AUTOMATION GROUP, SSD DRIVES EUROPE</b>                  NEW COURTWICK LANE, LITTLEHAMPTON, WEST SUSSEX BN17 7RZ                  TELEPHONE: +44(0)1903 737000 FAX: +44(0)1903 737100</p> <p><small>Registered Number: 4806503 England. Registered Office: 55 Maylands Avenue, Hemel Hempstead, Herts HP2 4SJ</small></p>	

The drive is CE marked in accordance with the low voltage directive for electrical equipment and appliances in the voltage range when installed correctly.

Since the potential hazards are mainly electrical rather than mechanical, the drive does not fall under the machinery directive. However, we do supply a manufacturer's declaration for when the drive is used (as a component) in machinery.

**650S 0.37 - 10kW 400V**



**EC DECLARATIONS OF CONFORMITY**

Date CE marked first applied: 19/10/2009

**EMC Directive**

In accordance with the EEC Directive 2004/108/EC

We Parker Hannifin Ltd., Automation Group, SSD Drives Europe, address as below, declare under our sole responsibility that the above Electronic Products when installed and operated with reference to the instructions in the Product Manual (provided with each piece of equipment) is in accordance with the relevant clauses from the following standard:-

BSEN61800-3 (2004)

**Low Voltage Directive**

In accordance with the EEC Directive 2006/95/EC

We Parker Hannifin Ltd., Automation Group, SSD Drives Europe, address as below, declare under our sole responsibility that the above Electronic Products when installed and operated with reference to the instructions in the Product Manual (provided with each piece of equipment), is in accordance with the following standard :-

EN50178 (1998)

The drive is CE marked in accordance with the low voltage directive for electrical equipment and appliances in the voltage range when installed correctly.

**MANUFACTURERS DECLARATIONS**

**EMC Declaration**

We Parker Hannifin Ltd., Automation Group, SSD Drives Europe, address as below, declare under our sole responsibility that the above Electronic Products when installed and operated with reference to the instructions in the Product Manual (provided with each piece of equipment) is in accordance with the relevant clauses from the following standard:-

BSEN61800-3 (2004)

**Machinery Directive**

The above Electronic Products are components to be incorporated into machinery and may not be operated alone.

The complete machinery or installation using this equipment may only be put into service when the safety considerations of the Directive 2006/42/EC are fully adhered to.

Particular reference should be made to EN60204-1 (Safety of Machinery - Electrical Equipment of Machines). All instructions, warnings and safety information of the Product Manual must be adhered to.

Since the potential hazards are mainly electrical rather than mechanical, the drive does not fall under the machinery directive. However, we do supply a manufacturer's

Dr Martin Payn (Conformance Officer)

declaration for when the drive is used (as a component) in machinery.

**PARKER HANNIFIN LIMITED, AUTOMATION GROUP, SSD DRIVES EUROPE**

NEW COURTWICK LANE, LITTLEHAMPTON, WEST SUSSEX BN17 7RZ

TELEPHONE: +44(0)1903 737000 FAX: +44(0)1903 737100

Registered Number: 4806503 England. Registered Office: 55 Maylands Avenue, Hemel Hempstead, Herts HP2 4SJ

Issued for compliance with the EMC Directive when the unit is used as *relevant apparatus*.

This is provided to aid your justification for EMC compliance when the unit is used as a component.



# Chapter 11: **Serial Communications**

Connection to the P3 Port ..... 11-2

# Connection to the P3 Port

---

**IMPORTANT:** *The drive MUST be earthed. Failure to do so could damage your communications ports.*

The port is an un-isolated RS232, 19200 Baud, supporting the standard EI bisynch ASCII communications protocol. Contact Parker SSD Drives for further information.

The P3 port is located under the terminal cover and is used only by the remote-mounted RS232 Keypad.

## P3 Port

A standard P3 lead is used to connect to the drive.

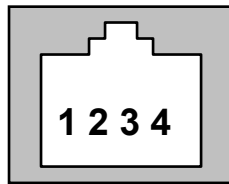

P3 Port Pin	Lead	Signal
1	Black	0V
2	Red	5V
3	Green	TX
4	Yellow	RX

**Note:** There is 5V present on pin 2 of the P3 port - do not connect this to your PC.

## Chapter 12: Applications

The Default Application .....	12-2
How to Load an Application.....	12-2
Application Description.....	12-3
• Control Wiring for Applications	12-3
• Application 1 : Basic Speed Control (default)	12-4
• Application 1: Basic Speed Control (default)	12-5
• Application 2 : Auto/Manual Control	12-6
• Application 3 : Preset Speeds	12-8
• Application 4 : Raise/Lower Trim	12-11
• Application 5 : PID	12-13



# The Default Application

The drive is supplied with 6 Applications, Application 0 to Application 5. Each Application recalls a pre-programmed structure of internal links when it is loaded.

DEFAULT

- Application 0 will not control a motor. Loading Application 0 removes all internal links.
- Application 1 is the factory default application, providing for basic speed control
- Application 2 supplies speed control using a manual or auto setpoint
- Application 3 supplies speed control using preset speeds
- Application 4 is a set-up providing speed control with Raise/Lower Trim
- Application 5 supplies speed control with Run Forward/Run Reverse

**IMPORTANT:** *Refer to Chapter 5: The Keypad – Special Menu Features to reset the drive to factory default values which are suitable for most applications.*

## How to Load an Application

In the **PAR** menu, go to **P I** and press the **M** key twice.

The Applications are stored in this menu.

Use the **▲** **▼** keys to select the appropriate Application by number.

Press the **E** key to load the Application.

# Application Description

## Control Wiring for Applications

The large Application Diagrams on the following pages show the full wiring for push-button starting. The diagrams on the reverse show the full wiring for single wire starting.

For the minimum connections to make the drive run refer to Chapter 3: "Installing the Drive" - Electrical Installation; the remaining connections can be made to suit your system.

When you load an Application, the input and output parameters shown in these diagrams default to the settings shown. For alternative user-settings refer to the Software Product Manual, Chapter 6 "Programming Your Application".

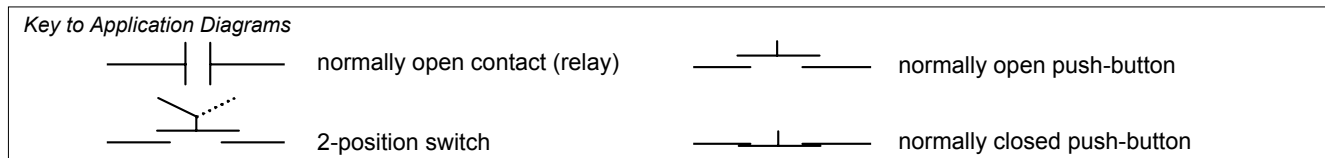

# Application 1 : Basic Speed Control (default)

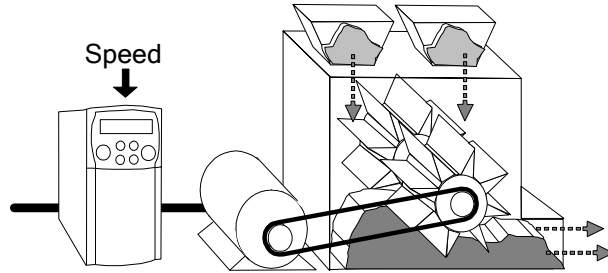

## Basic Speed Control

IDEAL FOR GENERAL PURPOSE APPLICATIONS

*Italic text indicates Default*

### STANDARD PARAMETERS

- p2 Max speed
- p3 Min speed
- p4 Accel time
- p5 Decel time
- p8 Jog setpoint
- p9 Stop mode
- p99 Password

### DIAGNOSTICS

- Frequency Hz
- Speed Setpt %
- DC Link Volts V
- Motor Current A

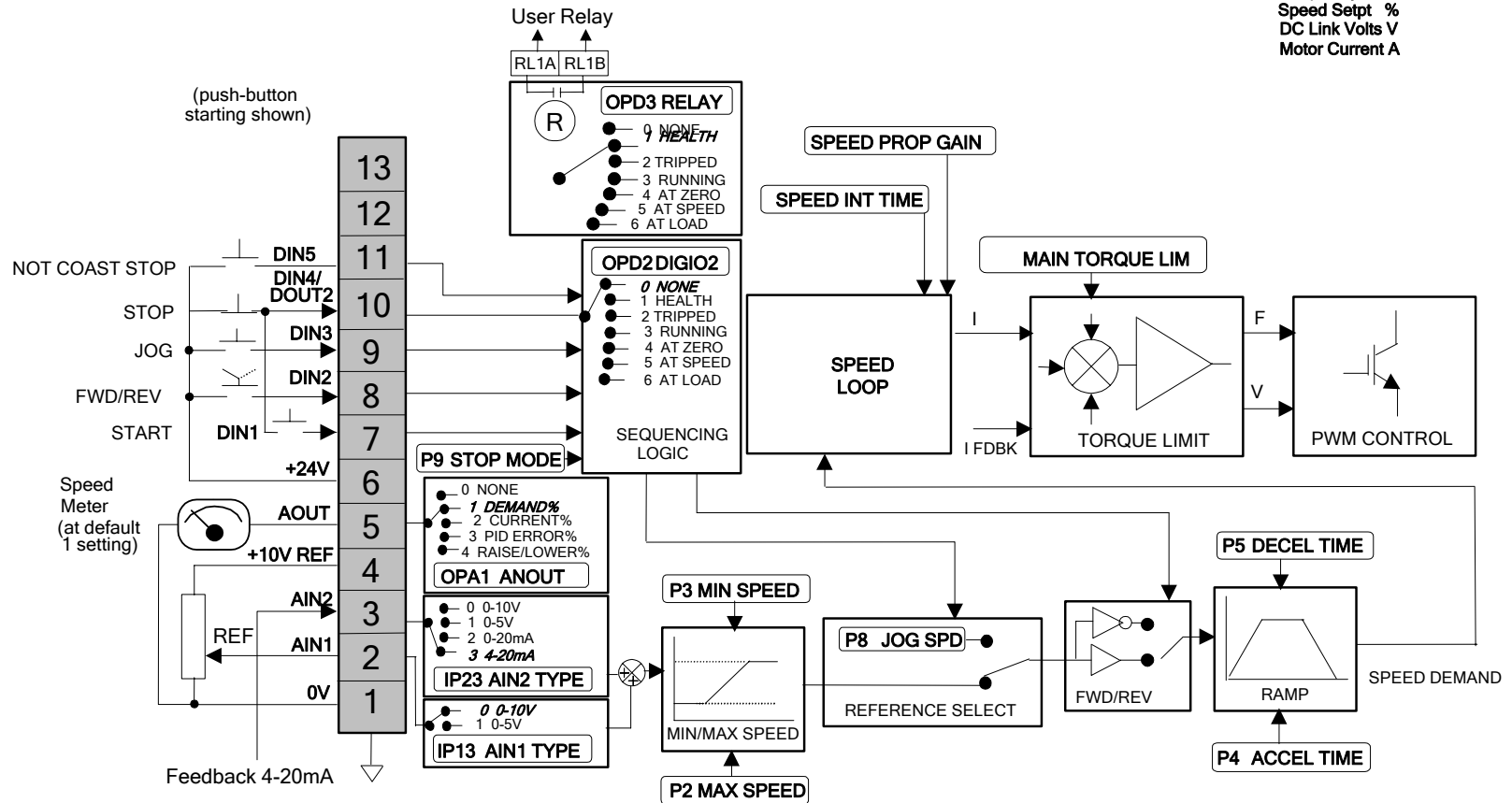

# Application 1: Basic Speed Control (default)

This Application is ideal for general purpose applications. It provides push-button or switched start/stop control. The setpoint is the sum of the two analogue inputs AIN1 and AIN2, providing Speed Setpoint + Speed Trim capability.

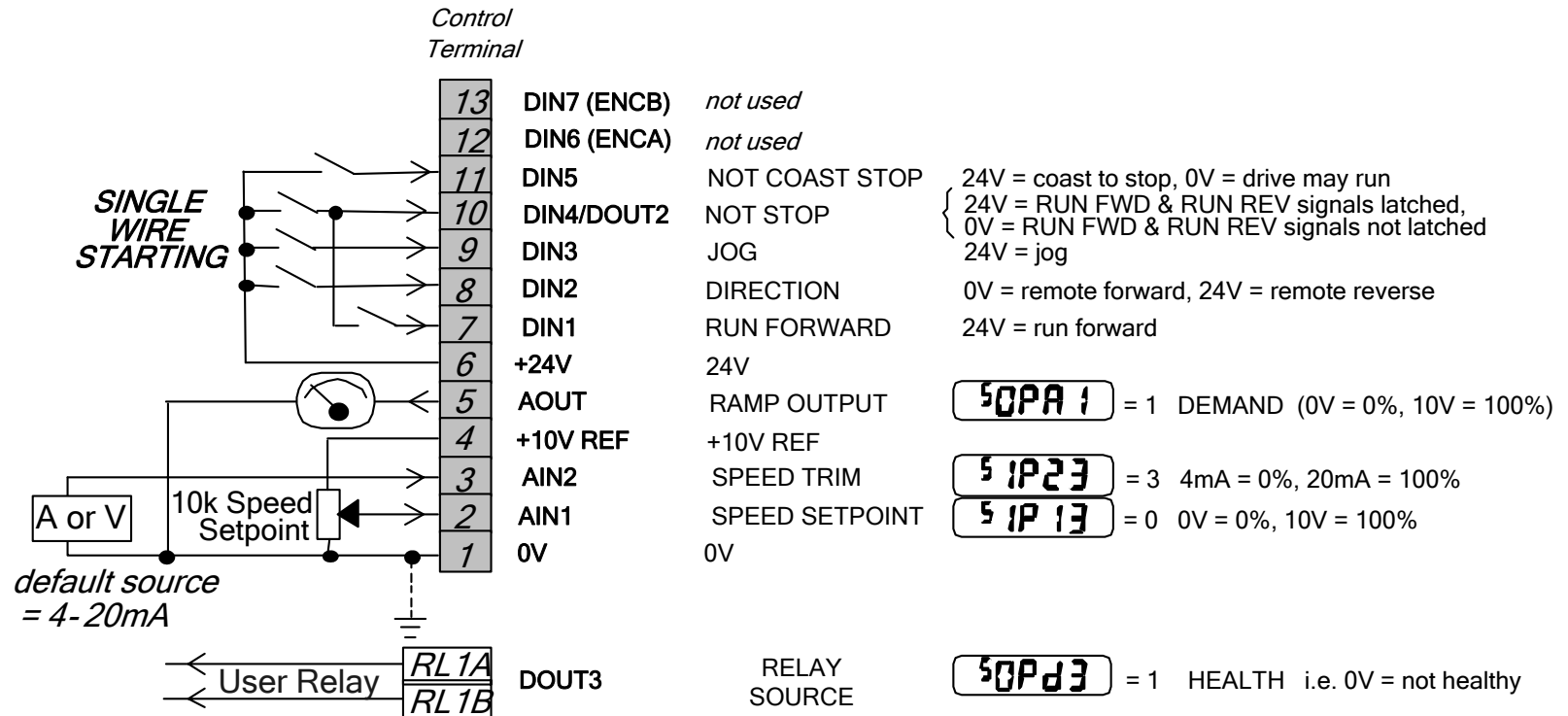

# Application 2 : Auto/Manual Control

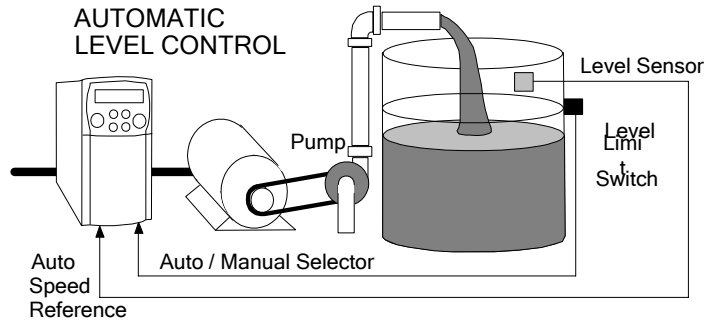

## Auto/Manual Control

IDEAL FOR AUTOMATIC CONTROL APPLICATIONS  
WITH LIMIT SWITCHES OR PROXIMITY TRANSDUCERS  
*Italic text indicates Default*

### STANDARD PARAMETERS

- p2 Max speed
- p3 Min speed
- p4 Accel time
- p5 Decel time
- p8 Jog setpoint
- p9 Stop mode
- p99 Password

### DIAGNOSTICS

- Frequency Hz
- Speed Setpt %
- DC Link Volts V
- Motor Current A

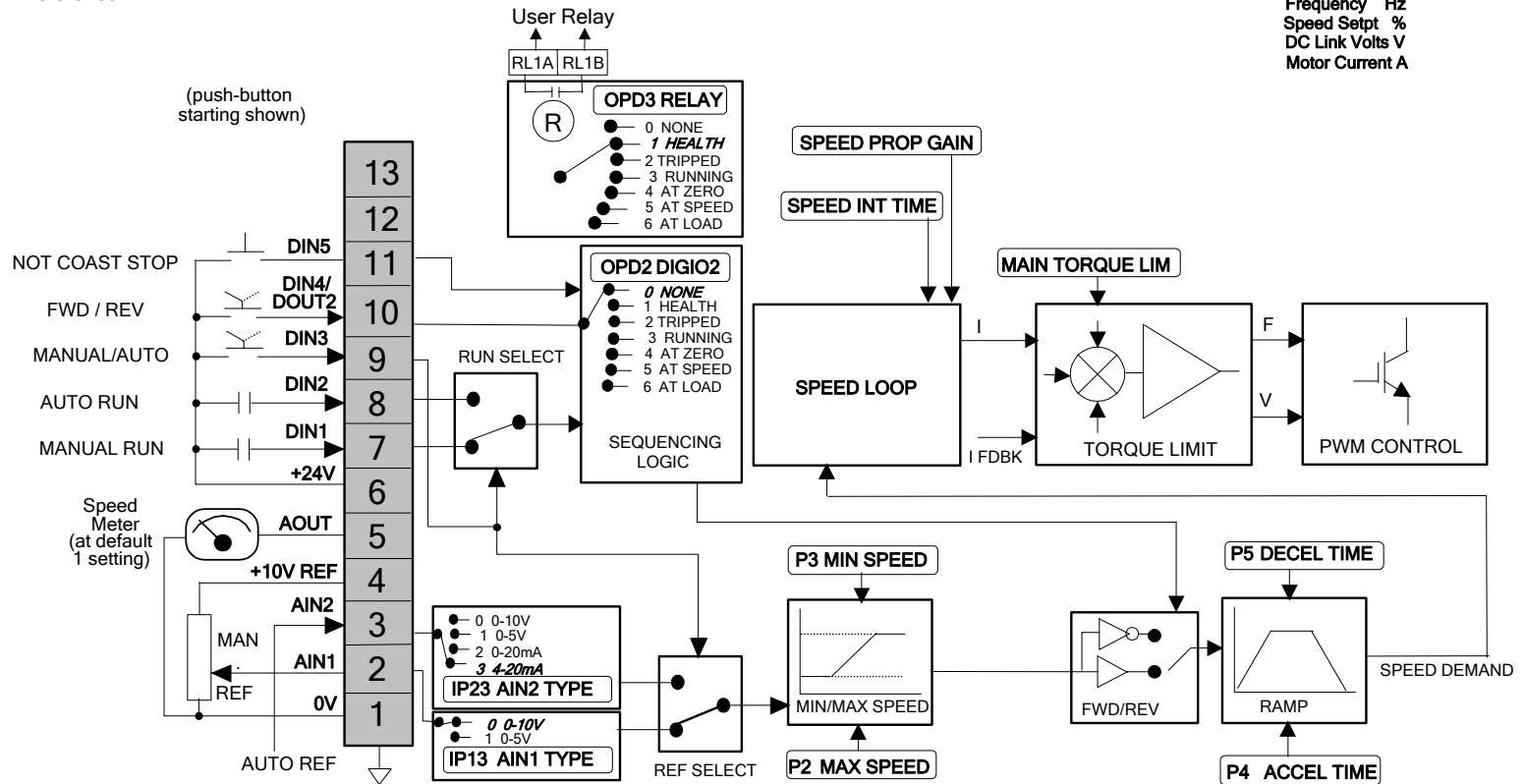

## Application 2: Auto/Manual Control

Two Run inputs and two Setpoint inputs are provided. The Auto/Manual switch selects which pair of inputs is active.

The Application is sometimes referred to as Local/Remote.

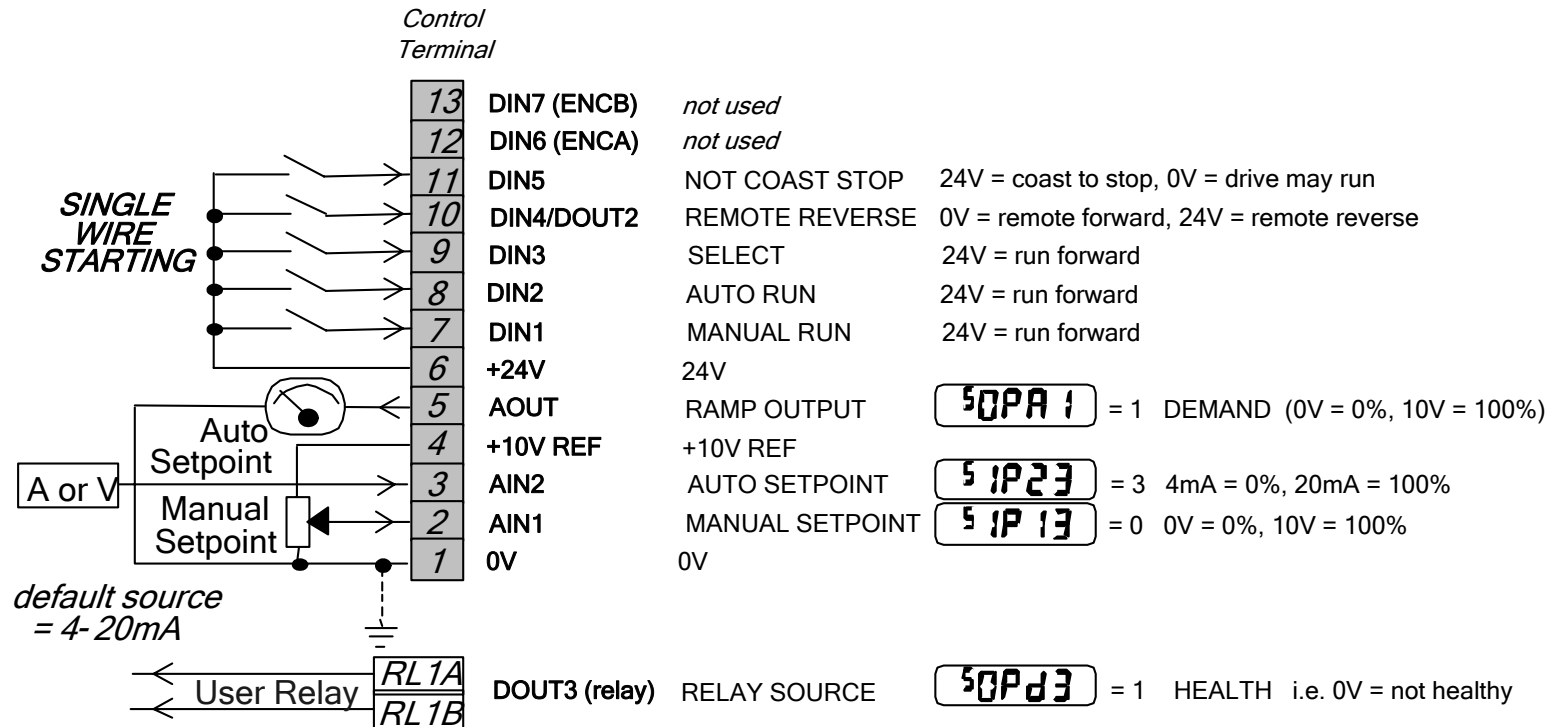

# Application 3 : Preset Speeds

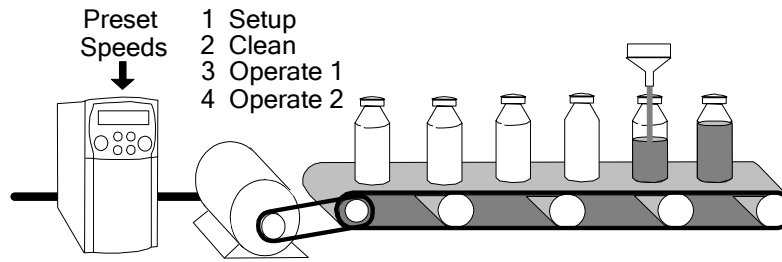

## Preset Speeds

IDEAL FOR APPLICATIONS REQUIRING MULTIPLE DISCRETE SPEED LEVELS

*Italic text indicates Default*

### STANDARD PARAMETERS

- p2 Max speed
- p3 Min speed
- p4 Accel time
- p5 Decel time
- p8 Jog setpt
- p9 Stop mode
- p99 Password

### DIAGNOSTICS

- Frequency Hz
- Speed Setpt %
- DC Link Volts V
- Motor Current A

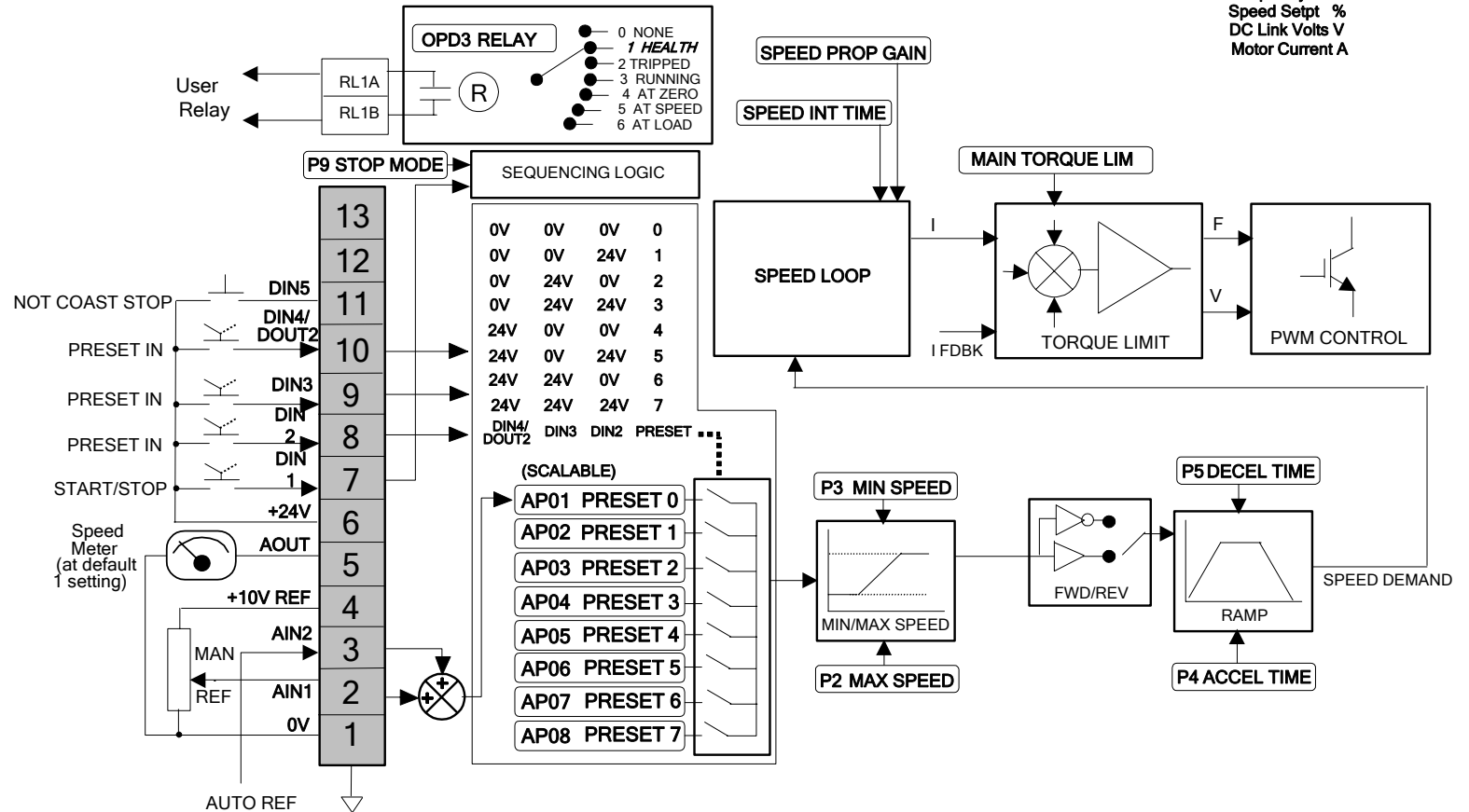

# Application 3: Preset Speeds

This is ideal for applications requiring multiple discrete speed levels.

The setpoint is selected from either the sum of the analogue inputs, (as in Application 1 and known here as PRESET 0), or as one of up to seven other pre-defined speed levels. These are selected using DIN2, DIN3 and DIN4, refer to the Truth Table below.

Edit parameters P302 to P308 on the keypad to re-define the speed levels of PRESET 1 to PRESET 7. Reverse direction is

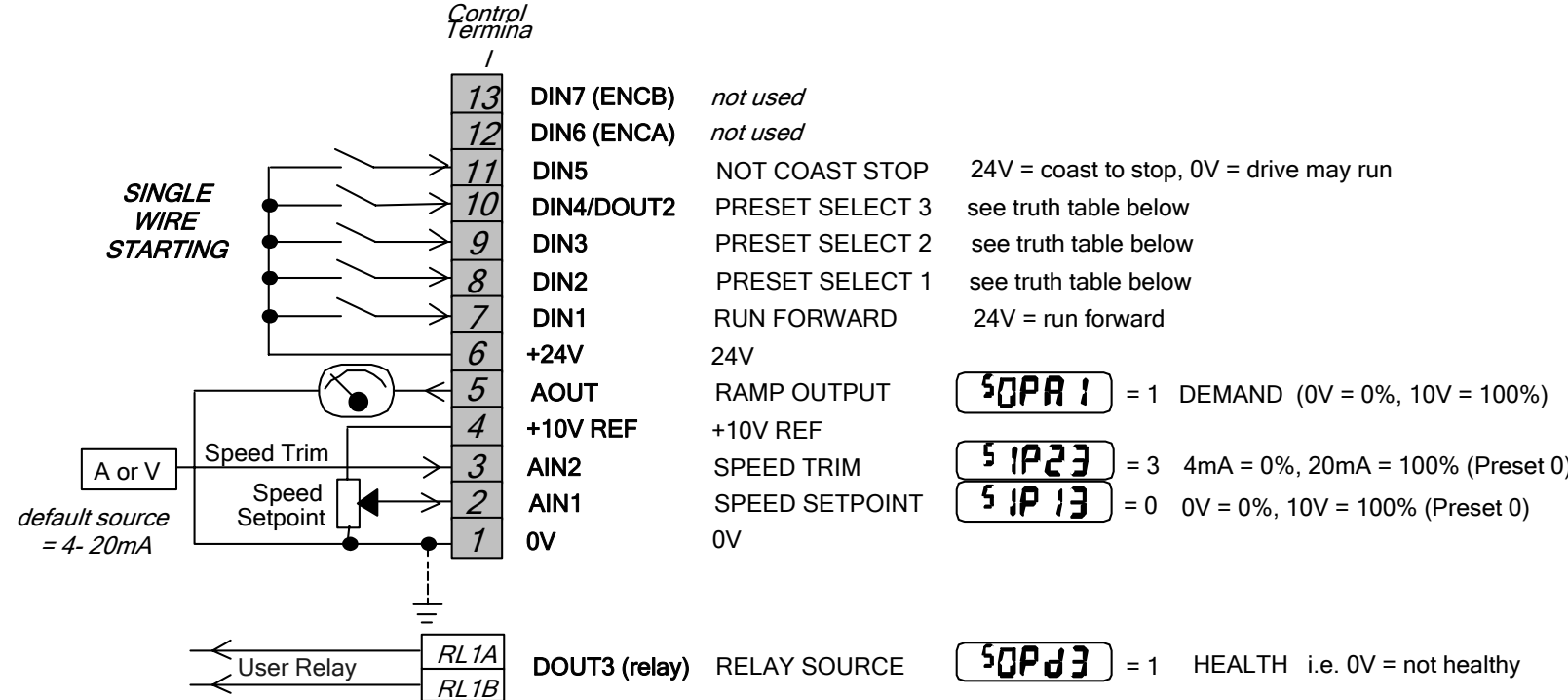

achieved by entering a negative speed setpoint.



**Preset Speed Truth Table**

DIN4/DOUT2	DIN3	DIN2	Preset
0V	0V	0V	0
0V	0V	24V	1
0V	24V	0V	2
0V	24V	24V	3
24V	0V	0V	4
24V	0V	24V	5
24V	24V	0V	6
24V	24V	24V	7

# Application 4 : Raise/Lower Trim

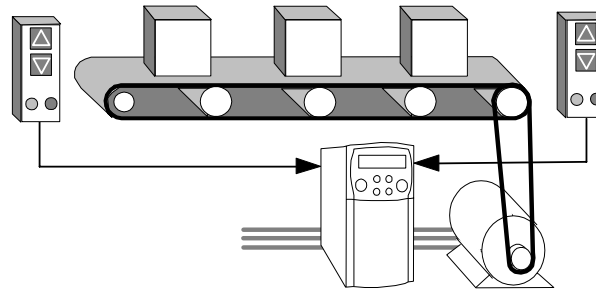

## Raise/Lower

IDEAL FOR APPLICATIONS REQUIRING SPEED CONTROL FROM MULTIPLE LOCATIONS

*Italic text indicates Default*

### STANDARD PARAMETERS

- p2 Max speed
- p3 Min speed
- p4 Accel time
- p5 Decel time
- p8 Jog setpoint
- p9 Stop mode
- p99 Password

### DIAGNOSTICS

- Frequency Hz
- Speed Setpt %
- DC Link Volts V
- Motor Current A

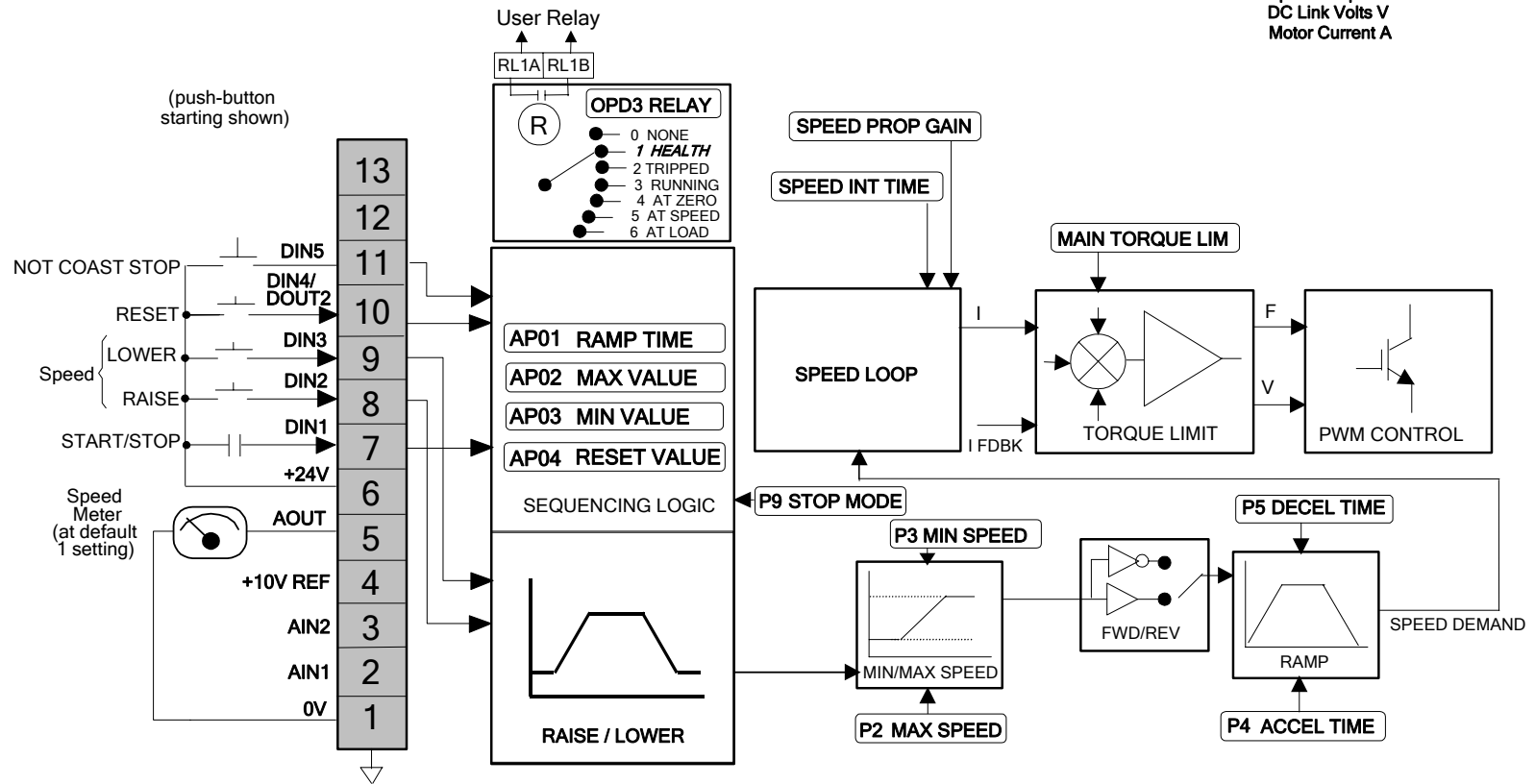

## Application 4: Raise/Lower Trim

This Application mimics the operation of a motorised potentiometer. Digital inputs allow the setpoint to be increased and decreased between limits. The limits and ramp rate can be set using the keypad.

The Application is sometimes referred to as Motorised Potentiometer.

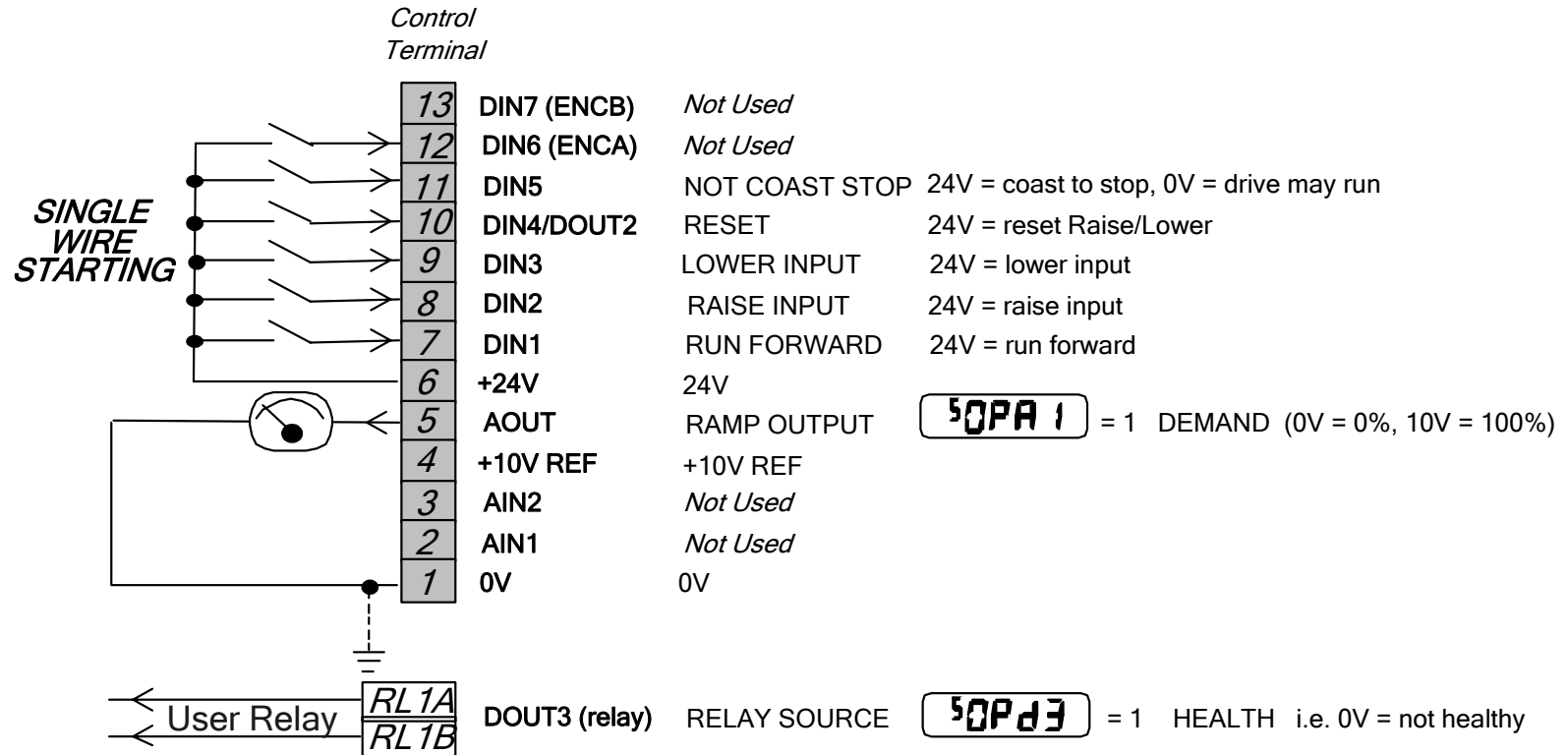

# Application 5 : PID

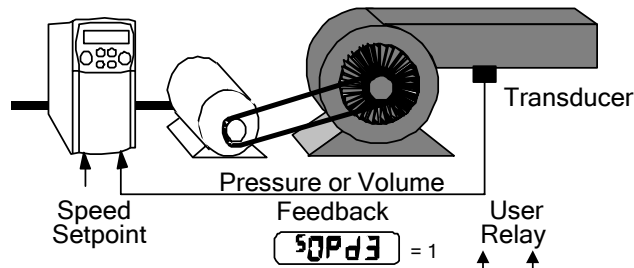

## PI Control

EASY TUNING FOR SETPOINT/FEEDBACK CONTROL  
 APPLICATIONS REGULATING VOLUME OR PRESSURE  
 SUCH AS AIR HANDLING OR PUMPING  
*Italic text indicates Default*

### STANDARD PARAMETERS

- p2 Max speed
- p3 Min speed
- p4 Accel time
- p5 Decel time
- p8 Jog setpoint
- p9 Run stop mode
- p99 Password

### DIAGNOSTICS

- Frequency Hz
- Speed Setpoint %
- DC Link Volts V
- Motor Current A

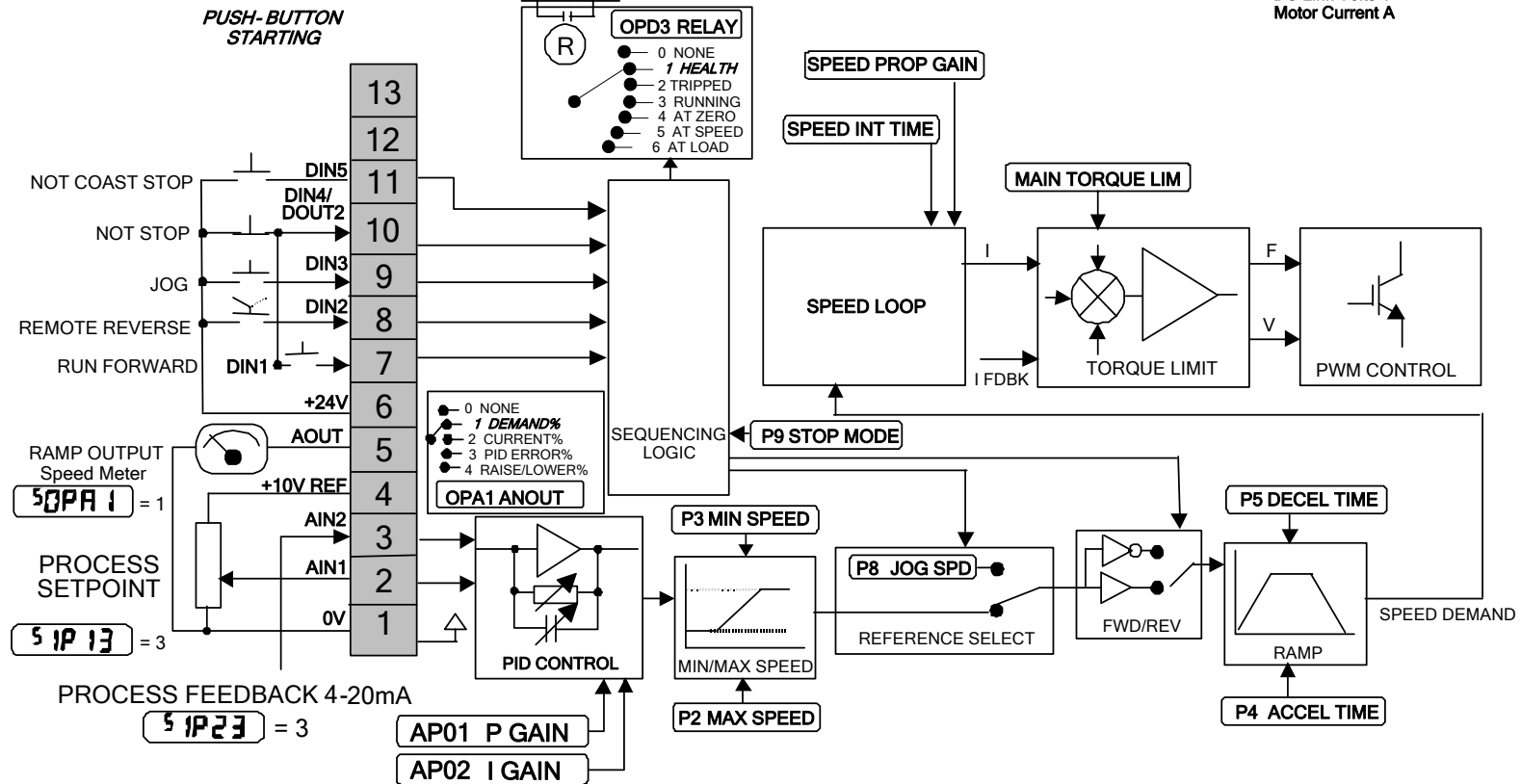

## Application 5: PID

A simple application using a Proportional-Integral-Derivative 3-term controller. The setpoint is taken from AIN1, with feedback signal from the process on AIN2. The scale and offset features of the analogue input blocks may be used to correctly scale these signals. The difference between these two signals is taken as the PID error. The output of the PID block is then used as the drive setpoint.

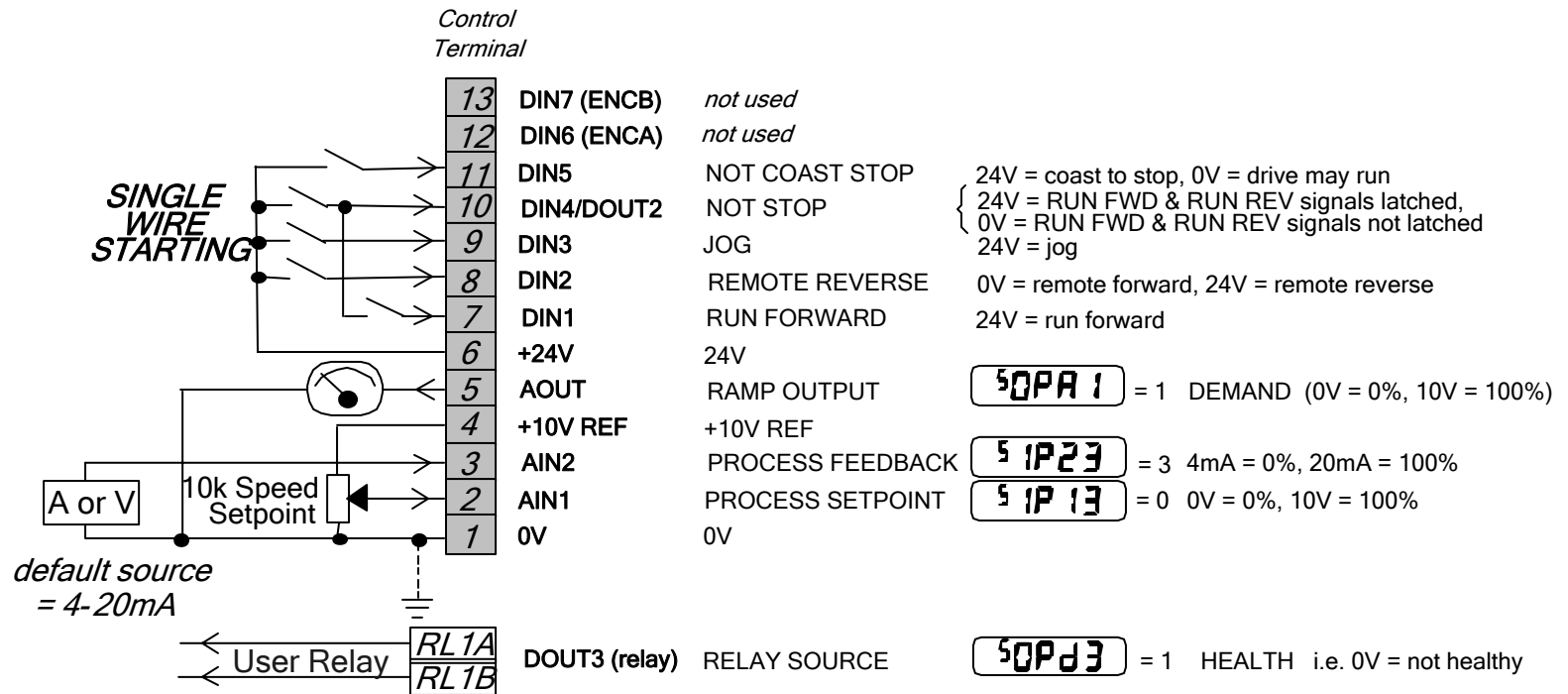



**UK Head Office: Parker SSD Drives**

New Courtwick Lane, Littlehampton, West Sussex BN17 7RZ  
Tel: +44 (0)1903 737000 Fax: +44 (0)1903 737100

**CANADA**

**Parker Hannifin Canada  
Motion and Control Division**  
160 Chisholm Drive  
Milton, Ontario L9T 3G9  
Tel: +1 (905) 693-3000  
Fax: +1 (905) 876-1958

**CHINA**

**Parker Hannifin Motion & Control  
(Shanghai) Co. Ltd.**  
280 Yunqiao Road,  
Jinqiao Export Processing Zone,  
Pudong District, Shanghai 201206  
Tel: +86(21)5031 2525  
Fax: +86(21)5854 7599

**FRANCE**

**Parker SSD Parvex**  
8 Avenue du Lac  
B.P. 249  
21007 Dijon Cedex  
Tel: +33 (0)3 80 42 41 40  
Fax: +33 (0)3 80 42 41 23

**GERMANY**

**Parker Hannifin GmbH**  
Von-Humboldt-Strasse 10  
64646 Heppenheim  
Tel: +49 (6252) 798200  
Fax: +49 (6252) 798205

**ITALY**

**Parker Hannifin SPA**  
Via C. Gounod, Cinisello Balsamo  
1-200092,  
Milano  
Tel: +39 (0236) 1081  
Fax: +39 (0236) 108400

**USA**

**Parker Hannifin Corporation  
SSD Drives**  
9225 Forsyth Park Drive  
Charlotte  
North Carolina 28273  
Tel: +1 (704) 588 3246  
Fax: +1 (704) 588 3249

Local availability and service support also in:

05/03/09

**SERVICE &  
REPAIR  
CENTRES**

Argentina • Australia • Austria • Bangladesh • Belgium • Brazil • Chile • Colombia • Costa Rica • Cyprus  
Czech Republic • Denmark • Ecuador • Egypt • Finland • Greece • Hong Kong • Hungary • India • Indonesia  
Iran • Ireland • Israel • Japan • Jordan • Kenya • Korea • Kuwait • Lithuania • Malaysia • Netherlands  
New Zealand • Nigeria • Norway • Peru • Philippines • Poland • Portugal • Qatar • Romania • Russia  
Saudi Arabia • Singapore • Slovenia • Slovakia • South Africa • Spain • Sri Lanka • Sweden • Switzerland  
Taiwan • Thailand • Turkey • United Arab Emirates • Vietnam • Zimbabwe

[www.ssddrives.com](http://www.ssddrives.com)

