

637F



Servo Drive



**Product
Manual**

Additional Supporting Documentation

UL:07-02-01



Product Manual Rack 6 U and EMV

UL:07-02-02-01



Product Manual Power Supply Plug-in Module NE B

UL: 07-02-09-02



Feedback System HIPERFACE®

UL:07-02-10-02



Product - Manual Safe Standstill SBT

UL:07-05-02-03



Product Manual SUCOnet K

UL:07-05-03-02



Product Manual Bus Interface CAN for 635 / 637F

UL:07-05-04-02



Product Manual Bus Interface DP for 635 / 637F

UL:07-05-05-02



Product Manual Bus Interface Interbus S for 635 / 637F

UL:07-05-07-02



Product Manual I/O Interface for 635 / 637F

UL:07-05-08-02



Product Manual Bus Interface Device Net for 635 / 637F

Additional Supporting Documentation

UL:07-09-04-02



Product Manual Suppression Aids EH

UL:10-06-03



Product Manual Serial Transfer Protocol
635 / 637 / 637+ / 637F EASY- Serial

UL: CD



EASYRIDER® Windows - Software

UL:10-06-05



Product Manual Software BIAS®

UL: 12-01



Product Manual Accessories - Plugs

UL:12-02



Product Manual Accessories - Cable

UL:12-03



Product Manual Ballast Resistors

©Parker Hannifin GmbH Co. KG

All rights reserved. No portion of this description may be produced or processed in any form without the consent of the company.

Changes are subject to change without notice.

Parker Hannifin has registered in part trademark protection and legal protection of designs. The handing over of the descriptions may not be construed as the transfer of any rights.

Made in Germany, 2007

Table of Contents

	Page
The Most Important Thing First	7
Safety Precautions	8
1 General Information.....	10
1.1 System Description	10
1.1.1 Digital Communication	11
1.1.2 Operation configurations	11
1.2 Modle Code	12
1.2.1 Combination <u>possibilities</u> for the various <u>communications</u> / I/O - modules.....	13
1.2.2 Layout module slots	14
1.2.3 Layout of Power Board.....	14
1.3 Range Data	15
1.3.1 Insulation Concept	15
1.3.2 General Data	15
1.3.3 Compact Units 637FK D6R.....	16
1.3.4 Plug-In Modules 637FD6R.....	17
1.3.5 Single- and Three-Phase Supply	18
1.3.6 Output Power	19
1.4 Dimensions.....	20
1.4.1 Dimensions for Compact Device and Plug-In Module	20
1.4.2 EMC-Clip (optional).....	21
2 Connector Assignments and Functions	22
2.1 General View of Connections for Compact Device 637F K D6R 02 – 10.....	22
2.1.1 637FK D6R 02...10 <u>Width 14 HP</u>	22
2.1.2 637FK D6R 16...30 <u>Width 20 HP</u>	23
2.2 Connector Pin Assignments and Contact Functions	24
2.2.1 Power Connections for <u>Plug-In Module</u> 637FD6R	24
2.3 Signal Connections	25
2.3.1 Control Signal Plug X10 - SUB D25 Socket.....	25
2.3.2 Pinning Control Signal Plug X10 - SUB D25 Socket	27
2.4 Feedback Sensor X30.....	28
2.4.1 Function module X300	28
2.4.2 Feedback Sensor Connection X30 (SUB D 09 Socket).....	29
2.5 Multi-Function X40	30
2.5.1 Incremental - <u>Output</u>	31
2.5.2 Incremental - <u>Input</u>	31
2.5.3 Stepper Motor <u>Input</u>	32
2.5.4 SSI-Encoder Interface	33
2.6 Digital Interfaces.....	34
2.6.1 Service Interface - COM1 (RS232)	34
2.7 Fieldbus- / IO- Interface <u>COM2</u>	35
2.7.1 Pinning for RS232	35
2.7.2 Pinning for RS422/485	35
2.7.3 Pinning for CAN or DeviceNet.....	36
2.7.4 Pinning for Profibus DP	36
2.7.5 Pinning for SUCOnet K	36
2.7.6 Pinning for EA5 - I/O-Interface (Digital In and Outputs).....	37
2.7.7 Pinning for I/O-Interface X200 (14 Inputs /10 Outputs)	38
2.8 Fieldbus- I/O- Interface <u>COM2</u> in Combination with <u>COM3</u>	39
2.8.1 Pinning for Interbus S (RP IBS)	39

Table of Contents

	Page
Connector Assignments and Functions	
2.9	Fieldbus-Module RP 2CA, 2C840
2.9.1	Pinning CAN1-BUS and CAN2-BUS.....40
2.9.2	Pinning RP 2C8 X120 (with I/O's).....40
2.10	Fieldbus Module RP CCA, RP CC8.....42
2.10.1	Pinning CAN1-BUS, CAN2-BUS and RS485.....42
2.10.2	Pinning RP CC8 X120 (with I/O's)42
2.10.3	DIP Switch Position for Option Module RP CCA and RP CC8.....43
2.11	Fieldbus Module RP PCA, RP PC844
2.11.1	Pinning Profibus DP, CAN2-BUS and RS485.....44
2.11.2	Pinning RP PC8 X120 (mit E/A's)44
2.11.3	DIP Switch Position for Option Module RP PCA, PC845
2.12	Option module RP SBT46
2.12.1	Safe Stop.....46
2.12.2	Brake control and PTC evaluation47
3	Operating modes 48
3.1	Operating Modes and pin functions49
3.2	Configurable pin-functions (depending on the operating mode).....50
3.3	Functions Diagrams with Protection Mode "Switch Off"51
4	Mechanical Installation 53
4.1	Mounting.....53
4.2	Control cabinet - mounting.....53
4.3	Cooling53
5	Electrical Installation 54
5.1	Safety54
5.2	The danger of electric shocks54
5.3	Danger areas.....54
5.4	Grounding, safety grounding.....54
5.4.1	Ground connections54
5.5	Short-circuit capability and discharge currents54
5.6	Fuses, contactors, filters55
5.7	Correction of supply current.....56
5.8	Brake resistor57
5.8.1	Selection of the brake resistor.....57
5.8.2	Configuration of the brake resistor58
6	Wiring Instructions 60
6.1	General Information60
6.2	Control cabling60
6.3	Power cabling.....60
6.4	Installation of the rack60
6.5	Analog setpoint.....60
6.6	Safety rules60
6.7	Electromagnetic compatibility (EMC)60
6.7.1	Hints for mounting61
6.7.2	Example for mounting62
6.7.3	Achievable specifications and conditions.....62
7	Parametrierung und Programmierung 63
7.1	Jumper63
7.2	Digital communication63

Table of Contents

	Page
8	Commissioning..... 64
8.1	Preparation.....64
8.2	Commissioning in steps65
9	Diagnosis and Trouble-Shooting 68
9.1	7-Segment Display68
9.2	Reset of a drive trouble72
9.3	Trouble shooting73
10	Block circuit diagram 74
11	General Technical Data..... 75
11.1	Power circuit.....75
11.2	Control circuit75
11.3	Signal inputs and outputs, connection X10.....75
11.4	Signal inputs and outputs, connection X120B resp. 120C.....76
11.5	Digital control.....76
11.6	Digitale communication77
11.7	Resolver evaluation/transmitter principle77
11.8	Controllsystem77
11.9	Analog-Outps78
11.10	Thermal data78
11.11	Mechanical data78
12	Disposal..... 79
13	Software..... 80
13.1	EASYRIDER® Windows - Software80
13.2	Parker programming language BIAS81
13.3	BIAS – Commands.....83
14	Certificates 84
15	Notes..... 89
16	Modification Record 90



The Most Important Thing First

Thank you for your confidence in choosing our products.

These operating instructions are intended to provide an overview of the technical data and features of our products.

Please read the operating instructions completely before operating the product.

Should you have any questions, please contact your nearest service representative.

	Improper application of this product in combination with dangerous high voltage can lead to serious injury or death.
	Damage can also occur to motors or other products. Therefore, we request that you strictly observe our safety and installation instructions.

Safety Precautions

We assume that as an expert, you are familiar with and will observe all of the relevant safety regulations, especially in accordance with VDE 0100, VDE 0113, VDE 0160, EN 50178, the accident prevention regulations of the employer's liability insurance company and the DIN regulations.

Additionally, it is imperative that all relevant European Union Safety Directives be observed.

Depending on the type and location of the installation, additional regulations, e.g. UL, DIN, must also be fully observed.

If our products are operated in connection with components from other manufacturers, their operating instructions are also subject to be strictly observed.

Safety Precautions



Attention !

Digital servo drives, corresponding to EN 50178/VDE 0160, are electronic power components utilized for the regulation of the flow of energy in high-voltage electrical power installations. They are exclusively designed, configured and approved to supply our servo motors. Handling, installation, operation, and maintenance are only permitted under the conditions of and in keeping with the effective and/or legal regulations, regulation publications and this technical document.

The operator must make sure that these regulations are strictly followed.

The Concept of Galvanic Separation and Insulation:

Galvanic separation and insulation corresponding to EN 50178/VDE 0160, provides for additional insulation protection.

In addition, all digital signal inputs and outputs are provided with a galvanic separation utilizing either a relay or an optical coupler. In this way, an increased level of protection against potential interference and a limitation of potential damage due to incorrect connections are provided.

The voltage level must not exceed the designated low safety voltage of 60V DC or 25V AC, respectively, in accordance with EN 50178/VDE 0160. The operator must make sure that these regulations are strictly followed.

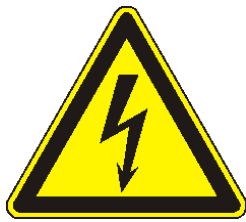

Danger !

**High Voltage!
Danger of Electrocutation!
Life Threatening Danger!**

Certain parts of the servo drive are supplied with dangerous electrical current. Physical contact with these components can cause death, life threatening injuries and/or serious damage to equipment and property.



Caution !

Due to safety considerations and product guarantees, the operator is prohibited from opening the servo drive case. Service, maintenance and repair of our products should only be carried out by specified representatives of the company. Expert configuration and professional installation, as described by this document, are the best way to insure problem-free operation of our servo drives!

**Please
Observe !**

Pay Special Attention to the Following:

Permissible Protection Class: Protective Grounding - operation is only permitted when the protective conductor is connected according to regulations.

Operation of the servo drive when employing a residual current operated protective device as the sole protection against indirect touching, is not permissible.

The servo drive may only be used in conjunction with machines or electrical systems when placed in control cabinets which comply with EEC- Directive 98/37/EEC (Machine Directive) and EEC Directive 89/336/EEC (EMC – Directive).

Work on or with the servo drive may only be carried out with insulated tools. Installation work may only be done in a de-energized state. When working on the

drive, one should not only block the active input, but also separate the drive completely from the main power connection.

CAUTION - Risk of Electrical Shock:

Wait 3 minutes after switching the component off to allow the capacitors to discharge.

Screws sealed with varnish fulfill an important protection function and may not be tampered with or removed.

It is prohibited to penetrate the inside of the unit with objects of any kind. Protect the unit from falling parts, pieces of wire, metal parts, etc., during installation or other work in the control cabinet. Metal parts can lead to a short-circuit in the servo drive.

Before putting the unit back into operation, remove any additional covers so that the unit does not overheat. When conducting measurements on the servo drive it is imperative to pay attention to the electrical isolation.



Stop !

We are not liable for damage which may occur when the product instructions and/or the applicable regulations are not explicitly observed!

1 General Information

1.1 System Description

The 5th generation of the digital servo drive serves to regulate the current, speed and position of **AC servo motors**, (standard: with resolver)

All control circuits and functions are realized digitally.

System variants

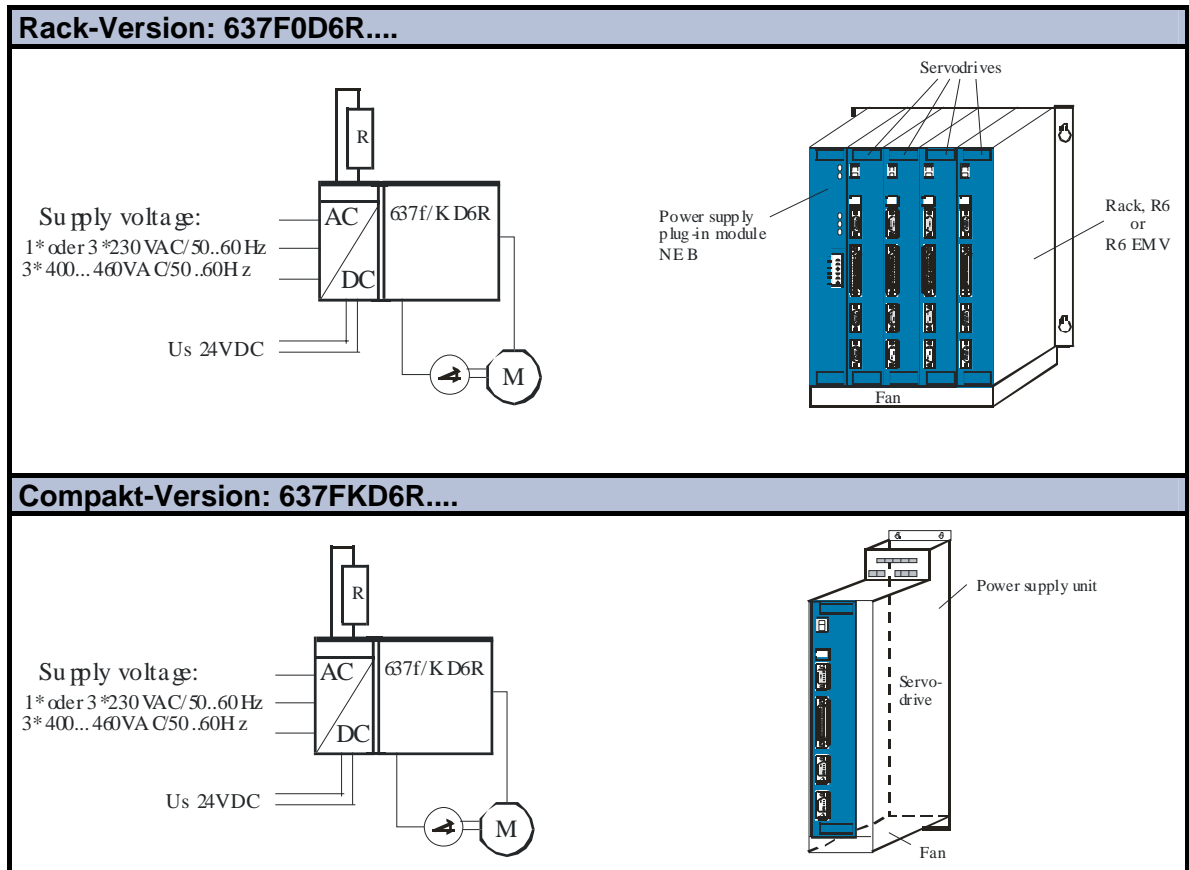

Explanations for the rack and power supply modules are documented in separate descriptions. If required, the returned braking energy can be drawn off into additional external ballast resistors. The AC-supply voltage is fed directly or via transformer to the associated power supply module.

The devices are designed to be operated on networks which are grounded at the centre point (TN networks) !

1.1.1 Digital Communication

Diagnostics / Setup

General: by 7 segment display

Comfortable: via PC with EASYRIDER® Windows – Software from version V8.xx
(serial interface RS232)

Communication

The serial-communication-protocol is open and fully documented.

(Explanation see separate documentation)

Every user has unrestricted access to all functions and parameters.

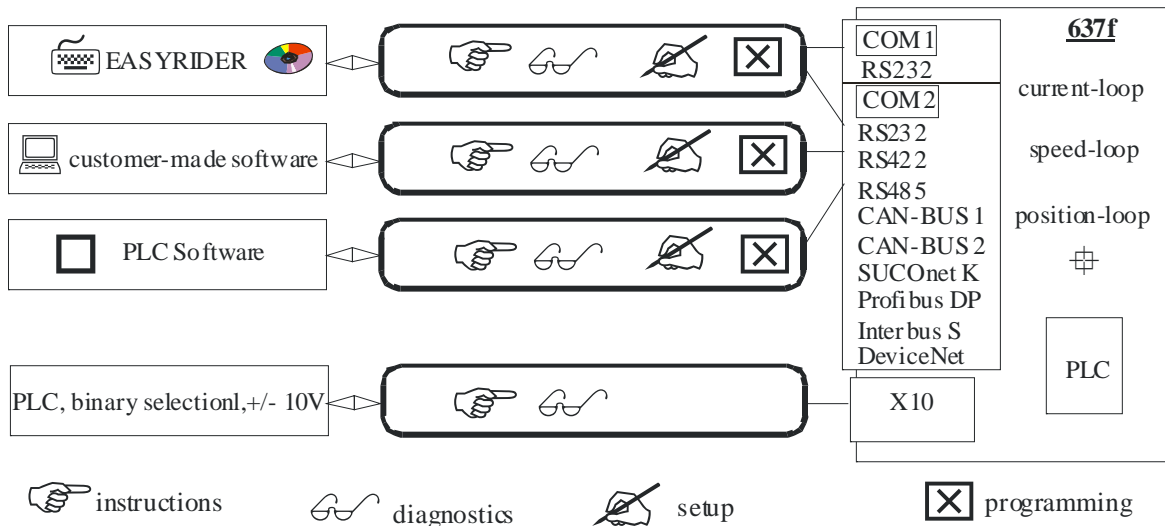

1.1.2 Operation configurations

There are opportunities ranging from simple current and speed control to programmable position control processes (PLC), supported by the 1500 BIAS command blocks.

"BIAS" User shell for intelligent drive controls

see:

- chapter 3 Operating modes
- chapter 13.2 BIAS commands
- chapter 13.3 Extended BIAS commands

1 General Information

1.2 Modle Code

Marking	Standard					optional			special	
	a	b	c	d	e	f1	f2	g	h	
Type:	637F	X	D6R	XX	X	X	XXX	XXX	XXX	XXX
Kennung	Beschreibung									
	637F	=	637F	≡	Fast Drive – Design, Digital servo drive 5 th generation					
a	K	=	1-axis-compact digital-servo drive system							
	0	=	Design plug-in device							
b	D6R	=	Digital 6U drive							
c			Rated current:							
	02	=	2 amps							
	04	=	4 amps							
	06	=	6 amps							
	10	=	10 amps							
	16	=	16 amps							
	22	=	22 amps							
	30	=	30 amps							
d			Intermediate circuit rated voltage:							
	3	=	325V (230V AC) 16..30A only as rack system possible							
	7	=	650V (460V AC)							
e	E	=	With EMC-Clip unit							
	0	=	Without EMC-Clip unit							
f1			Additional RP xxx option modules on the drive for communication via COM2							
	000	=	None option							
	232	=	RS 232 Interface					≡ Slot A (A, B)		
	422	=	RS 422 Interface					≡ Slot A (B)		
	485	=	RS 485 Interface					≡ Slot A (B)		
	CAN	=	CAN – Bus					≡ Slot A (B)		
	2CA	=	2 x CAN (without I/O's)					≡ Slot B (A) / [C*]		
	2C8	=	2 x CAN + 4 outputs and 4 inputs					≡ Slot B (A) / [C*]		
	CCA	=	2 x CAN + RS 485					≡ Slot B (A)		
	CC8	=	2 x CAN + 4 outputs and 4 inputs + RS 485					≡ Slot B (A)		
	DEV	=	CAN - Bus / DeviceNet					≡ Slot B (A)		
	SUC	=	SUCOnet K					≡ Slot B (A)		
	PDP	=	Profibus DP					≡ Slot B (A)		
	IBS	=	Interbus S (Attention: changed front plate)					≡ Slot B (A)		
	PC8	=	Profibus DP + CAN2 + outputs and 4 inputs + RS 485					≡ Slot B (A)		
	PCA	=	Profibus DP + CAN2 + RS 485					≡ Slot B (A)		
	EA5	=	I/O - Interface (5 inputs, 2 outputs)					≡ Slot B (A)		
f2			Additional option modules on the drive via X200 (Attention: changed front plate)							
	000	=	None option							
	EAE	=	I/O - Interface (14 Inputs, 10 Outputs)					≡ Slot C		
	SBT	=	Safety – Board Module					≡ Slot C		
g			X300 – Function module							
	RD2	=	Standard X30 Resolver – Module 2 nd version					≡ Slot D		
	HF2	=	HIPERFACE – Module 2 nd version					≡ Slot D		
	SC2	=	Sinus / Cosinus - Module 2 nd version					≡ Slot D		
h			Entry only at use							
	S01	=	Special - brake resistor - setting / 7500; ED 40%							
	S02	=	Special - brake resistor - setting / 9900; ED 50%							
	X7x	=	Broad-band contact X10.7 - X10.8							
	BSx	=	Protection moisture condensation							
	B7x	=	Protection moisture condensation + Broad-band contact X10.7 - X10.8							
	923	=	Jumper 209 / 2 - 3 closed , by SBT - Option Thermo - Contact X30 (PTC / NTC)							
	Z23	=	Custom-specific software + Jumper 209 / 2 - 3 closed , by SBT - Option Thermo - Contact X30 (PTC / NTC)							
	0BF	=	Without front panle (blue)							

at assignment [C] Interface you can used CAN2 *

1.2.1 Combination possibilities for the various communications / I/O - modules

Slots →	A				B										C				
	2	4	4	C	2	2	C	C	D	S	P	I	E	P	P	E	S	*2	*2
	3	2	8	A	C	C	C	C	E	U	D	B	A	C	C	A	B	C	C
Option modules →	2	2	5	N	A	8	A	8	V	C	P	S	5	8	A	E	T	A	8
Type code ↓																			
637FxD6Rxxxx232000xxx	●	-	-	-	-	-	-	-	-	-	-	-	-	-	-	-	-	-	-
637FxD6Rxxxx232EAExxx	●	-	-	-	-	-	-	-	-	-	-	-	-	-	-	●	-	-	-
637FxD6Rxxxx232SBTxxx	●	-	-	-	-	-	-	-	-	-	-	-	-	-	-	-	●	-	-
637FxD6Rxxxx2322CAxxx	●	-	-	-	-	-	-	-	-	-	-	-	-	-	-	-	-	●	-
637FxD6Rxxxx2322C8xxx	●	-	-	-	-	-	-	-	-	-	-	-	-	-	-	-	-	-	●
637FxD6Rxxxx422000xxx	-	●	-	-	-	-	-	-	-	-	-	-	-	-	-	-	-	-	-
637FxD6Rxxxx422EAExxx	-	●	-	-	-	-	-	-	-	-	-	-	-	-	-	●	-	-	-
637FxD6Rxxxx422SBTxxx	-	●	-	-	-	-	-	-	-	-	-	-	-	-	-	-	●	-	-
637FxD6Rxxxx4222CAxxx	-	●	-	-	-	-	-	-	-	-	-	-	-	-	-	-	-	●	-
637FxD6Rxxxx4222C8xxx	-	●	-	-	-	-	-	-	-	-	-	-	-	-	-	-	-	-	●
637FxD6Rxxxx485000xxx	-	-	●	-	-	-	-	-	-	-	-	-	-	-	-	-	-	-	-
637FxD6Rxxxx485EAExxx	-	-	●	-	-	-	-	-	-	-	-	-	-	-	-	●	-	-	-
637FxD6Rxxxx485SBTxxx	-	-	●	-	-	-	-	-	-	-	-	-	-	-	-	-	●	-	-
637FxD6Rxxxx4852CAxxx	-	-	●	-	-	-	-	-	-	-	-	-	-	-	-	-	-	●	-
637FxD6Rxxxx4852C8xxx	-	-	●	-	-	-	-	-	-	-	-	-	-	-	-	-	-	-	●
637FxD6RxxxxCAN000xxx	-	-	-	●	-	-	-	-	-	-	-	-	-	-	-	-	-	-	-
637FxD6RxxxxCANEAExxx	-	-	-	●	-	-	-	-	-	-	-	-	-	-	-	●	-	-	-
637FxD6RxxxxCANSBTxxx	-	-	-	●	-	-	-	-	-	-	-	-	-	-	-	-	●	-	-
637FxD6Rxxxx2CA000xxx	-	-	-	-	●	-	-	-	-	-	-	-	-	-	-	-	-	-	-
637FxD6Rxxxx2CAEAExxx	-	-	-	-	●	-	-	-	-	-	-	-	-	-	-	●	-	-	-
637FxD6Rxxxx2CASBTxxx	-	-	-	-	●	-	-	-	-	-	-	-	-	-	-	-	●	-	-
637FxD6Rxxxx2C8000xxx	-	-	-	-	-	●	-	-	-	-	-	-	-	-	-	-	-	-	-
637FxD6Rxxxx2C8EAExxx	-	-	-	-	-	●	-	-	-	-	-	-	-	-	-	●	-	-	-
637FxD6Rxxxx2C8SBTxxx	-	-	-	-	-	●	-	-	-	-	-	-	-	-	-	-	●	-	-
637FxD6RxxxxCCA000xxx	-	-	-	-	-	-	●	-	-	-	-	-	-	-	-	-	-	-	-
637FxD6RxxxxCCA EAExxx	-	-	-	-	-	-	●	-	-	-	-	-	-	-	-	●	-	-	-
637FxD6RxxxxCCASBTxxx	-	-	-	-	-	-	●	-	-	-	-	-	-	-	-	-	●	-	-
637FxD6RxxxxCC8000xxx	-	-	-	-	-	-	-	●	-	-	-	-	-	-	-	-	-	-	-
637FxD6RxxxxCC8EAExxx	-	-	-	-	-	-	-	●	-	-	-	-	-	-	-	●	-	-	-
637FxD6RxxxxCC8SBTxxx	-	-	-	-	-	-	-	●	-	-	-	-	-	-	-	-	●	-	-
637FxD6RxxxxDEV000xxx	-	-	-	-	-	-	-	-	●	-	-	-	-	-	-	-	-	-	-
637FxD6RxxxxDEVEAExxx	-	-	-	-	-	-	-	-	●	-	-	-	-	-	-	●	-	-	-
637FxD6RxxxxDEVSBTxxx	-	-	-	-	-	-	-	-	●	-	-	-	-	-	-	-	●	-	-
637FxD6RxxxxSUC000xxx	-	-	-	-	-	-	-	-	-	●	-	-	-	-	-	-	-	-	-
637FxD6RxxxxSUCEAExxx	-	-	-	-	-	-	-	-	-	●	-	-	-	-	-	●	-	-	-
637FxD6RxxxxSUCSBTxxx	-	-	-	-	-	-	-	-	-	●	-	-	-	-	-	-	●	-	-
637FxD6RxxxxPDF000xxx	-	-	-	-	-	-	-	-	-	-	●	-	-	-	-	-	-	-	-
637FxD6RxxxxPDFEAExxx	-	-	-	-	-	-	-	-	-	-	●	-	-	-	-	●	-	-	-
637FxD6RxxxxPDFSBTxxx	-	-	-	-	-	-	-	-	-	-	●	-	-	-	-	-	●	-	-
637FxD6RxxxxPDF2CAxxx	-	-	-	-	-	-	-	-	-	-	●	-	-	-	-	-	-	●	-
637FxD6RxxxxPDF2C8xxx	-	-	-	-	-	-	-	-	-	-	●	-	-	-	-	-	-	-	●
637FxD6RxxxxBS000xxx	-	-	-	-	-	-	-	-	-	-	-	●	-	-	-	-	-	-	-
637FxD6RxxxxBSEAExxx	-	-	-	-	-	-	-	-	-	-	-	●	-	-	-	●	-	-	-
637FxD6RxxxxBSSBTxxx	-	-	-	-	-	-	-	-	-	-	-	●	-	-	-	-	●	-	-
637FxD6RxxxxEA5000xxx	-	-	-	-	-	-	-	-	-	-	-	-	●	-	-	-	-	-	-
637FxD6RxxxxEA5EAExxx	-	-	-	-	-	-	-	-	-	-	-	-	●	-	-	●	-	-	-
637FxD6RxxxxEA5SBTxxx	-	-	-	-	-	-	-	-	-	-	-	-	●	-	-	-	●	-	-
637FxD6RxxxxPC8000xxx	-	-	-	-	-	-	-	-	-	-	-	-	-	●	-	-	-	-	-
637FxD6RxxxxPC8EAExxx	-	-	-	-	-	-	-	-	-	-	-	-	-	●	-	●	-	-	-
637FxD6RxxxxPC8SBTxxx	-	-	-	-	-	-	-	-	-	-	-	-	-	●	-	-	●	-	-
637FxD6RxxxxPCA000xxx	-	-	-	-	-	-	-	-	-	-	-	-	-	-	●	-	-	-	-
637FxD6RxxxxPCAEAExxx	-	-	-	-	-	-	-	-	-	-	-	-	-	-	●	●	-	-	-
637FxD6RxxxxPCASBTxxx	-	-	-	-	-	-	-	-	-	-	-	-	-	-	●	●	-	-	-
637FxD6Rxxxx000EAExxx	-	-	-	-	-	-	-	-	-	-	-	-	-	-	-	●	-	-	-
637FxD6Rxxxx000SBTxxx	-	-	-	-	-	-	-	-	-	-	-	-	-	-	-	-	●	-	-

000 = none Option ● possible combination

* at assignment [C] Interface you can used CAN2 *



1 General Information

1.2.2 Layout module slots

Module slots:

A -232
-422
-485
-CAN

B -2CA -PDP
-2C8 -IBS
-CCA -EA5
-CC8 -PCA
-DEV -PC8
-SUC

C -EAE
*-2CA
*-2C8

Motor - Feedbacksysteme:

D -RD2: Standard Resolver
-HF2: Option HIPERFACE®
-SC2: Option Sinus/Cosinusr

at assignment [C] Interface you can used CAN2 *

Note: The option modules of the slots A / B / C can only be reached after removing the cooling plate.

1.2.3 Layout of Power Board

View solder side (solder jumper)

JP2.8
JP2.3
JP2.7
JP2.2

JP101. 1/ 2/ 3

JP102 1/ 3/ 2

JP100 2/ 3/ 1

JP1 1/ 3/ 2

JP2 2/ 3/ 1

JP3 1/ 3/ 2

JP4 2/ 3/ 1

JP209. 1/ 2/ 3

Solder jumper function
see: Chapter 7.1

1.3 Range Data

1.3.1 Insulation Concept

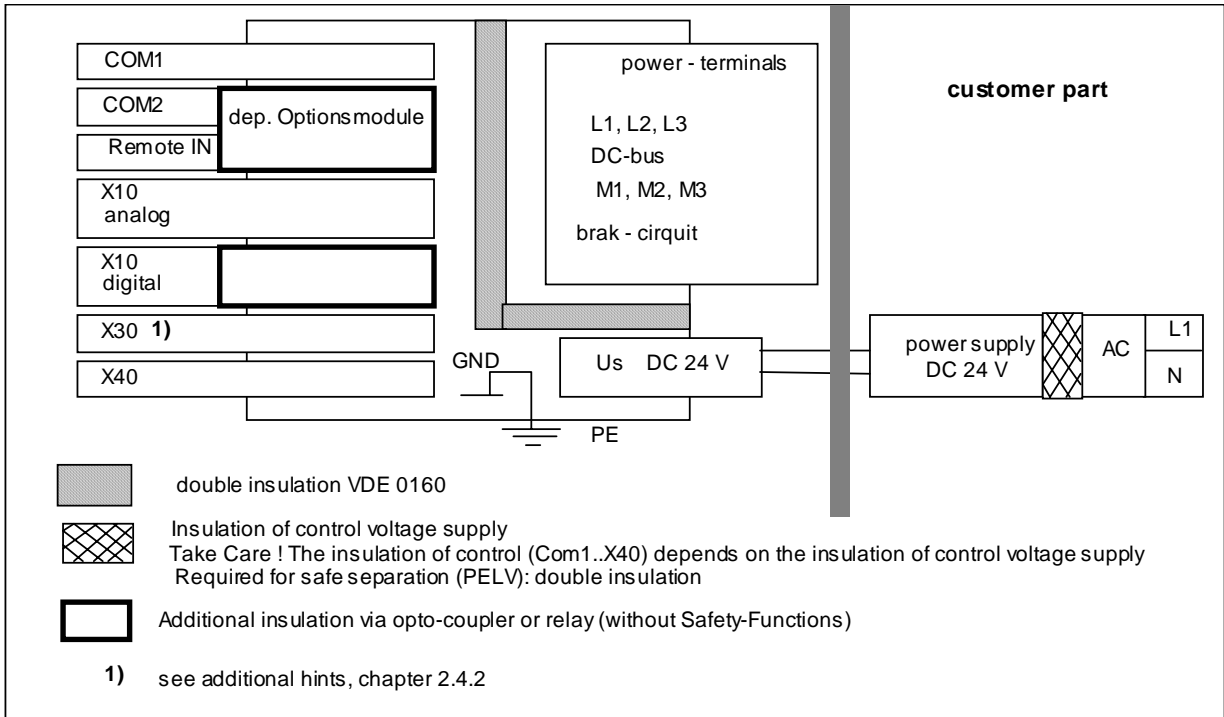

1.3.2 General Data

Enclosure Rating - for Mounting in a Cubicle		IP20
Operating Temperature Range		EN 50178 / VDE 0160, class 3K3
Storage Temperature Range		-25°...+55° C
Air Pressure		86 kPa - 106 kPa
Humidity		5% - 85%, 40°C
Operating Temp		0...40°C
Reduced Operation De-rating of the Output Current	1)	>40°...< 50°C 2% /°C
Altitude h		h ≤ 1000m
Reduced Operation De-rating of the Output Current	1)	h > 1000...≤ 2000m 1% / 100m
Safety Over Voltage - Category of Power Circuit		EN 50178 / VDE 0160, UL, cUL III,
Pollution Degree - for Mounting in a Cubicle		VDE / UL: 2
Vibration Test in Accordance with DIN IEC 68-2-6, Test FC Condition for Testing Frequency Range Amplitude Acceleration Test Time per Axis Frequency Sweep Speed		10...57Hz 57...150Hz 0,075 mm 1g 10 sweep cycle 1 octave/min

1) Use only fan-cooled devices. For reduced operating conditions, no UL approval is available.

1 General Information

1.3.3 Compact Units 637FK D6R

Compact Units	637F		KD6R02		KD6R04		KD6R06		KD6R10		KD6R16	KD6R22	KD6R30	
	-3	-7	-3	-7	-3	-7	-3	-7	-3	-7	-7	-7	-7	
Input														
Supply Voltage	min.	[V]	14											
50..60 Hz	Un	[V]	230	460	230	460	230	460	230	460	460	460	460	
	max.	tolerance	+ 10%											
Phases			1;3	3	1;3	3	1;3	3						
Supply Preparation			Fuses, contacts, filters see chapter 5.6											
Power-On Current Limit	model		NTC 4 Ohm						NTC 2 Ohm					
Control Voltage	¹⁾ Us	[V]	21,5....24....29, attention: insulation-concept chapter 1.3.1											
Control Current incl. Fan	Is DC	[A]	Continuous: max. 1,2A Power-On-Peak: nom. 3A; max.. 6A / 0,8 mS, 2,5A / 25 mS						Continuous: max 1,5A Power-On-Peak: nom. 3A; max. 6A / 0,8 mS, 3A / 25 mS					
Output														
Sine-Wave Voltage at Un	Unr	[Veff]	220	447	220	447	220	447	220	447	447	447	447 ³⁾	
De-rating of Unr			depending upon load and single or 3-phase supply. (see chapter 1.3.5)											
Rated Current RMS	Inr	[A]	2	4	4	8	6	10	16	22	30 ³⁾			
Max. Current RMS Time for Imax	⁴⁾ Imaxr min.	[A] Sec	4 5	8 5	12 5	20 5	32 5	44 5	60 5					
Min. Motor Inductance (terminal / terminal)	Lph/ph	[mH]	6,0	12,0	3,0	6,0	2,0	4,0	1,2	2,4	2,0	1,1	0,8	
Brake Circuit														
Setpoint DC	Ub	[V]	375	730	375	730	375	730	375	730	730	730	730	
Max. Power	Pbmax	[kW]	4,5	8,7	4,5	8,7	6,7	13,0	11,2	21,7	29,0	34,8	34,8	
Continuous Power	Pbnenn	[W]	≤ 560											
Internal Resistor	Rbint	[Ω]	100	300	100	300	100	300	100	300	-----			
	Pd	[W]	30	30	30	30	30	30	30	30				
	Pmax	[kW]	1,4	1,7	1,4	1,7	1,4	1,7	1,4	1,7				
Min. External Resistor	²⁾ Rbextmin	[Ω]	47	82	47	82	27	47	15	27	20	15	15	
General														
Power Loss Fan, Electronic	PE loss	[W]	29	29	29	29	29	29	29	29	36	36	36	
Fan Models 24V DC		[V]	2 Piece L 024 / (12TE * 25) 1 Piece L 024 / (12TE * 15)						2 Piece L 024 / (16TE x 25)					
									1 Piece L 024 / (16TE x 20)		2 Piece L 024 / (16TE x 20)			
Power Stage per A		[W/A]	9	12	9	12	9	12	9	12	12	12	12	
Weight		[kg]	5,0						8,8					
Additional Data			see: chapter 11											

- 1) Suggested: transformer-based supply
- 2) Use only Parker-released types
- 3) Max. continuous performance reduced to 80%, see chapter 1.3.6
- 4) References chapter 1.3.6

1.3.4 Plug-In Modules 637FD6R

Plug-In Modules	637F		0D6R02		0D6R04		0D6R06		0D6R10		0D6R16		0D6R22		0D6R30		
			-3	-7	-3	-7	-3	-7	-3	-7	-3	-7	-3	-7	-3	-7	
Input																	
DC-BUS Rated	min.	[V]	20														
	U _g	[V]	325	650	325	650	325	650	325	650	325	650	325	650	325	650	
	max.	tolerance	+ 10%														
Control Voltage	U _s	[V]	24V DC +20% -10%, attention: insulation-concept chapter 1.3.1														
Control Current	¹⁾ I _s DC	[A]	Continuous: max 0,8A Power-On-Peak: nom. 2A; max 5A / 0,8 mS, 2A / 25mS														
Fan	²⁾ Typ		---	L220 K	---	L220K						L220G					
Output																	
Sine-Wave Voltage at U _n	Unr	[V _{eff}]	220	447	220	447	220	447	220	447	220	447	220	447	220	447	³⁾ 447
De-rating of Unr			depending on load and single or 3-phase supply (see chapter 1.3.5)														
Rated Current RMS	I _{nr}	[A]	2		4		6		10		16		22		30 ³⁾		
Max. Current RMS Time for I _{max}	I _{maxr}	[A] min.	4 5 Sec		8 5 Sec		12 5 Sec		20 5 Sec		32 5 Sec		44 5 Sec		60 5 Sec		
Min. Motor Inductance (terminal / terminal)	L _{ph/ph}	[mH]	6,0	12,0	3,0	6,0	2,0	4,0	1,2	2,4	1,0	2,0	0,55	1,1	0,4	0,8	
Brake-Circuit																	
Setpoint DC	U _b	[V]	375	730	375	730	375	730	375	730	375	730	375	730	375	730	
Max. Power	P _{bmax}	[kW]	4,5	8,7	4,5	8,7	6,7	13,0	11,2	21,7	15,0	29,0	18,0	34,8	18,0	34,8	
Continuous Rating	P _{bnenn}	[W]	≤ 560														
Min. External Resistor	²⁾ R _{bextmin}	[Ω]	33	63	33	63	22	43	12	24	10	20	8,2	15	8,2	15	
General																	
Power Loss Electronic Output Stage per A	PE loss	[W] [W/A]	20 9	20 12	20 9	20 12	20 9	20 12	20 9	20 12	20 9	20 12	20 9	20 12	20 9	20 12	
Weight		[kg]	1,5									4,0					
Additional Data			see chapter 11														

- 1) Suggested: transformer-based supply
- 2) Use only Parker-released types
- 3) Max. continuous performance reduced to 80%, **see** chapter 1.3.6
- 4) References chapter 1.3.6

1 General Information

1.3.5 Single- and Three-Phase Supply

Due to the line-ripple of the DC-Bus, the rate of usable output voltage is reduced as follows. This reduction affects the maximum attainable speed of the applied motor.

Three-phase supply:

The unloaded output voltage will be reduced to approx. 90%, maximally 85 %

Single-phase supply: 50 – 60 Hz

only servo drive 637F / ..02 up to 06
see the following diagram:

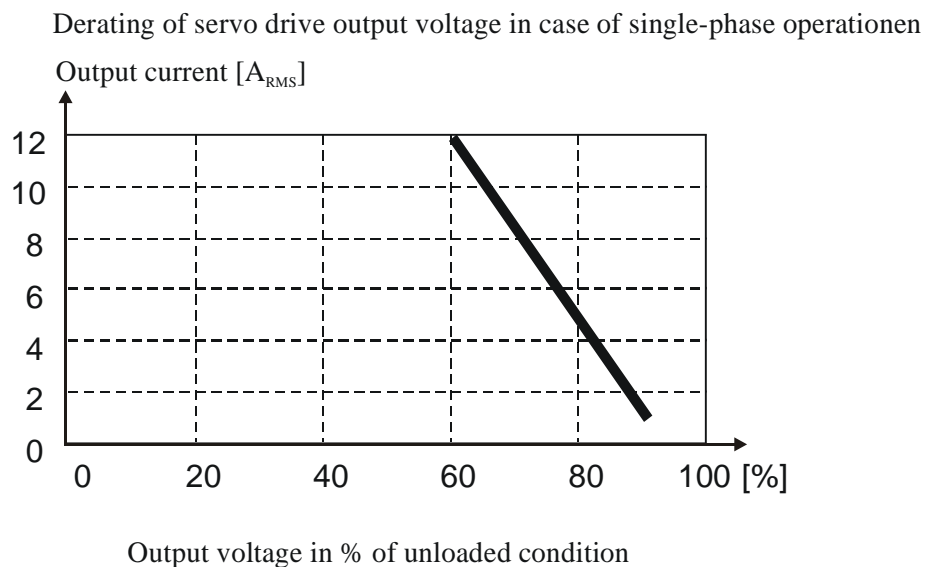

Hint for parameterization:

To avoid unexpected tripping of the under voltage threshold, the parameter setting should be left on default values (EASYSRIDER® Windows – Software).

Required motor-terminal-voltage for specified speed.

Approximation: (up to 3000RPM)

$$U_{kl} = 1,2 * (EMF * n / 1000) + I * (R_{ph} + R_L) [V]$$

U_{kl} Required motor voltage [V_{RMS}]

EMF Back-EMF of motor [V_{RMS}] / 1000 RPM

R_{ph} Resistance of motor (between terminals) [Ω]

R_L Line resistance of motor cable [Ω]

I Motor-current [A_{RMS}]

1.3.6 Output Power

In case of continuous operation in the full-load range, the limits as shown in the following diagram need to be respected. Typical servo applications are not affected by this restriction. (S3 operation: Start/Stop).

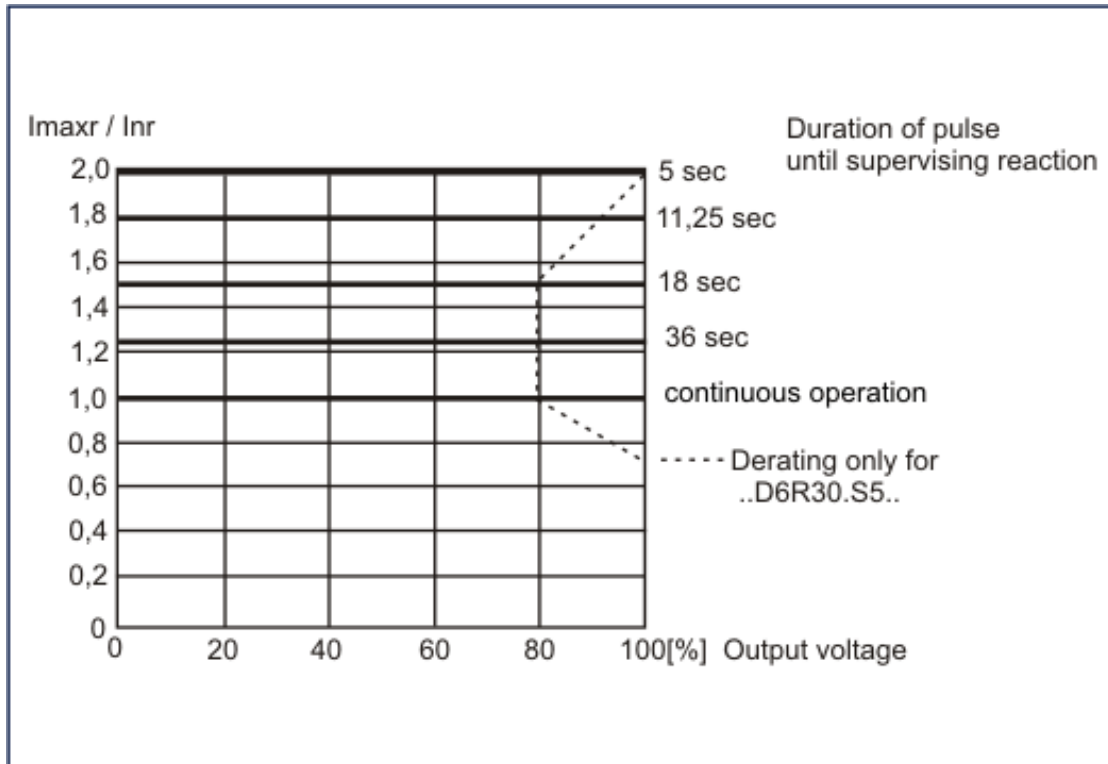

1 General Information

1.4 Dimensions

1.4.1 Dimensions for Compact Device and Plug-In Module

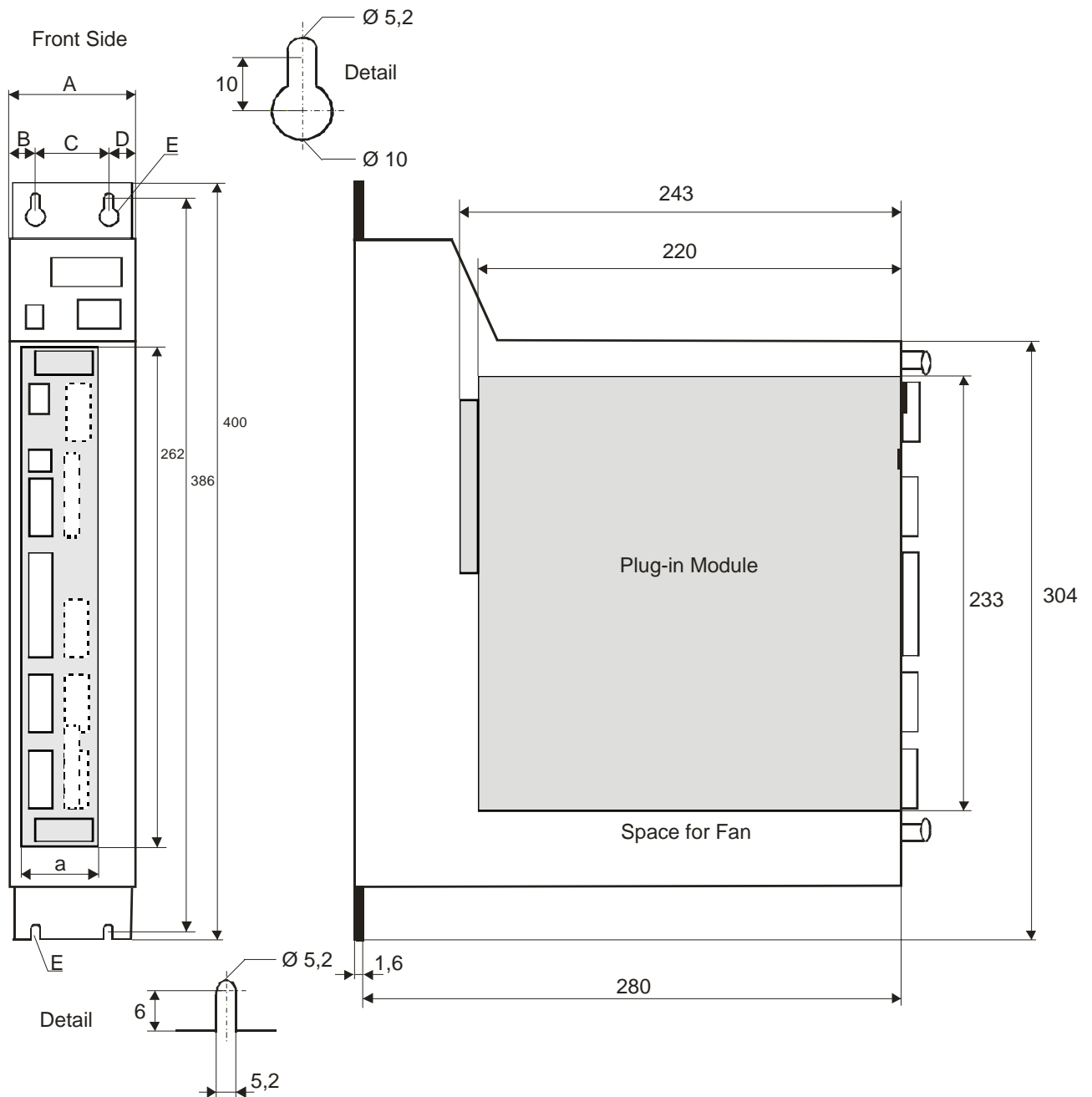

	637FK D6R 02...10	width	637FK D6R 16...30	width
A	64,5 ±0,5 mm	14 HP	105,1 ±0,5 mm	20 HP
B	17,5 ±0,5 mm		17,0 ±0,5 mm	
C	30,0 ±0,1 mm		71,1 ±0,1 mm	
D	17,0 ±0,5 mm		17,0 ±0,5 mm	
a	40,2 ±0,5 mm	8 HP	80,4 ±0,5 mm	16 HP

1 HP ≈ 5,08mm

Important Note:

You will need additional space on the front side, of approx. 70 mm, for the signal mating plugs!

1.4.2 EMC-Clip (optional)

1.4.2.1 For 8 HP Drive

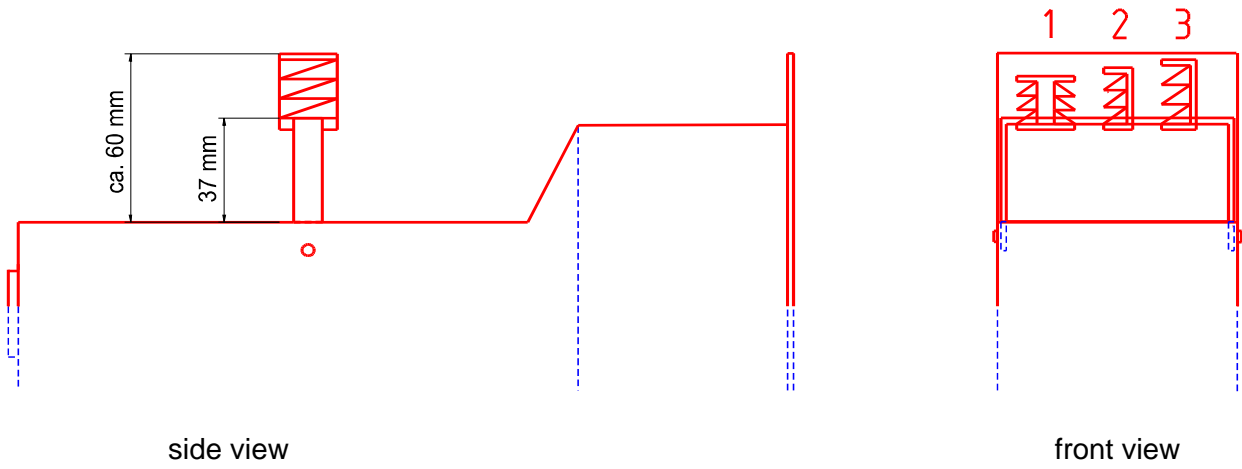

1.4.2.2 For 16 HP Drive

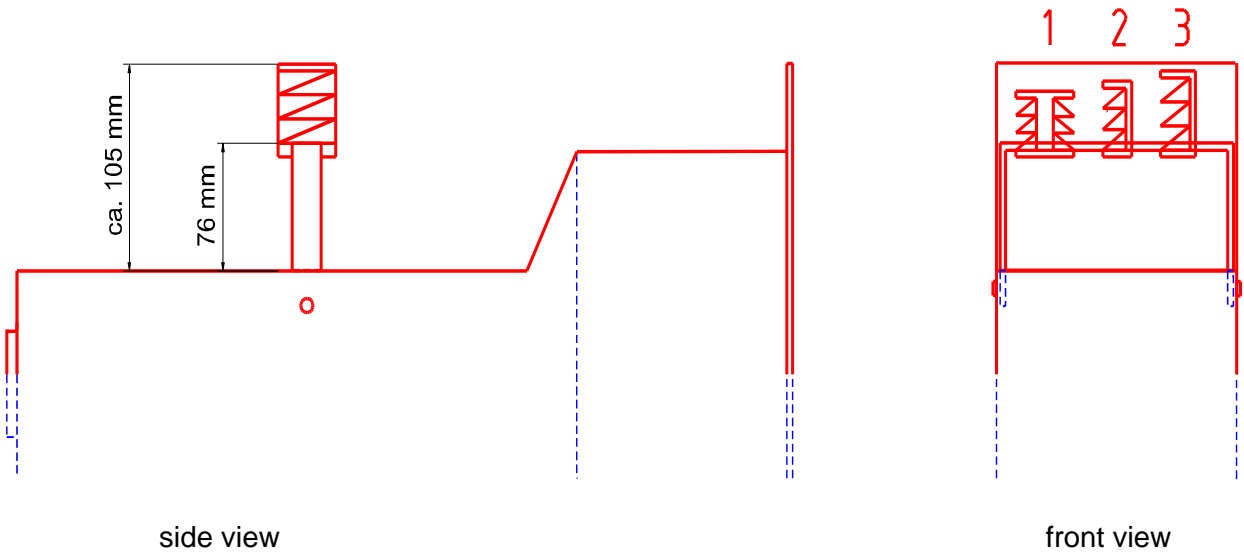

EMC - Clip for	
Feedback cable (e.g. Resolver)	1
Mains cable	2
Motor cable	3

Meaning:
cage clamp terminals = 1, 2, 3

2 Connector Assignments and Functions

2.1 General View of Connections for Compact Device 637F K D6R 02 – 10

2.1.1 637FK D6R 02...10 Width 14 HP

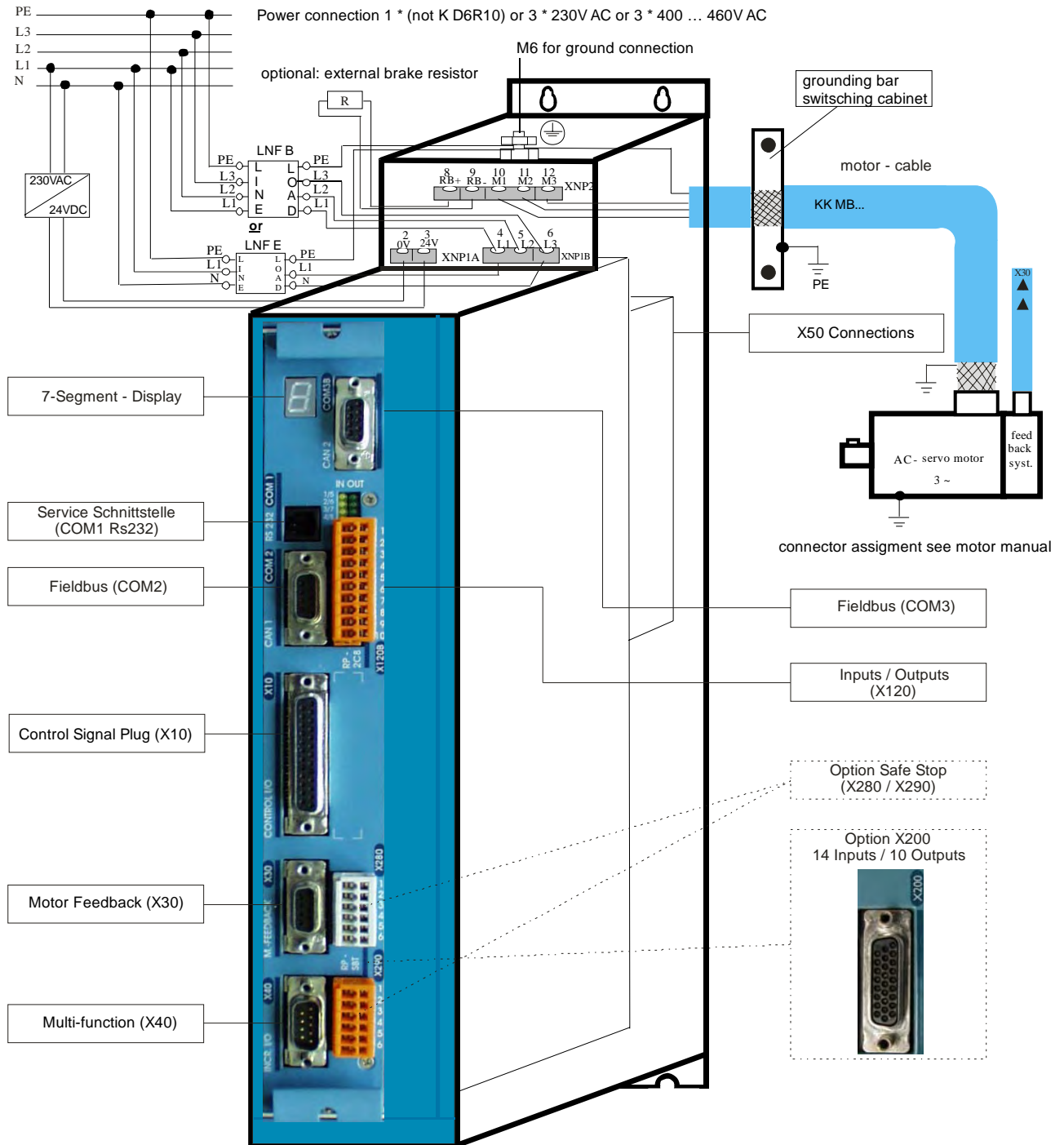

2.1.2 637FK D6R 16...30 Width 20 HP

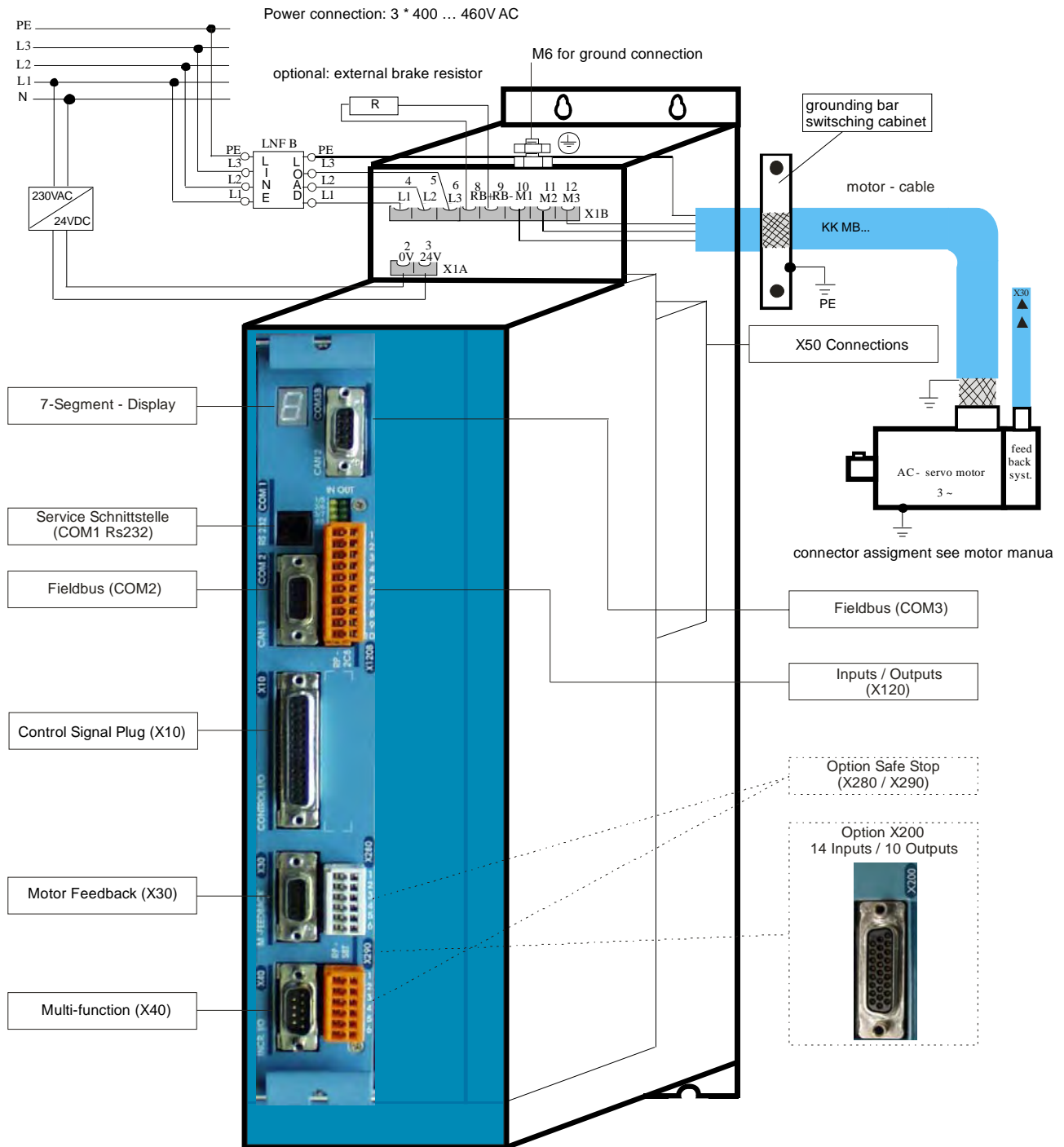

2 Connector Assignments and Functions

2.2 Connector Pin Assignments and Contact Functions

2.2.1 Power Connections for Plug-In Module 637FD6R (at the rear of the rack) (H15 multiple pin strip according to DIN 41612)

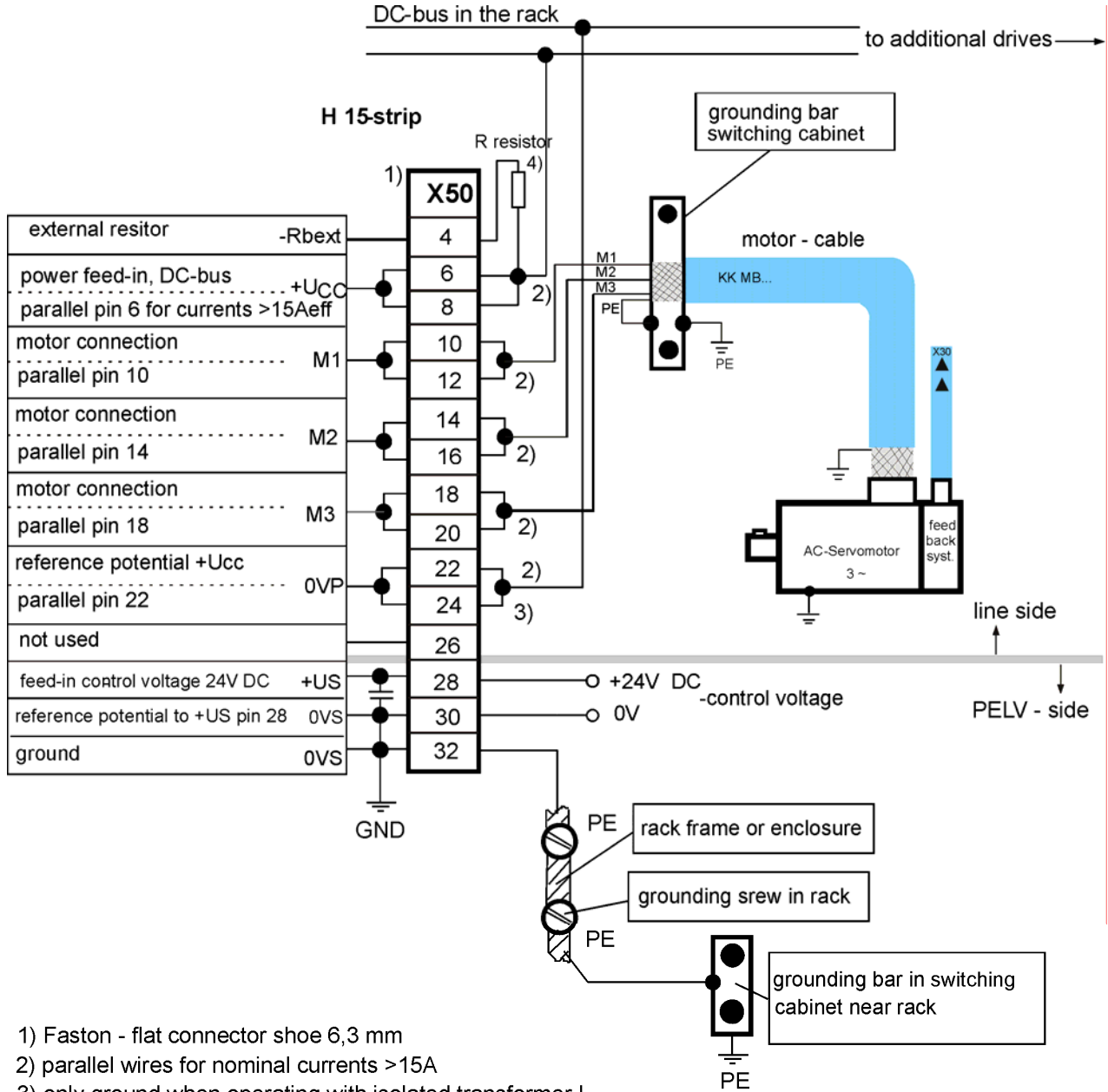

- 1) Faston - flat connector shoe 6,3 mm
- 2) parallel wires for nominal currents >15A
- 3) only ground when operating with isolated transformer !
Do not ground when operating with autotransformer or directly on mains!
- 4) resistor, provided that it is not accessed from power unit NEB.

2.3 Signal Connections

2.3.1 Control Signal Plug X10 - SUB D25 Socket Complete Representation X10

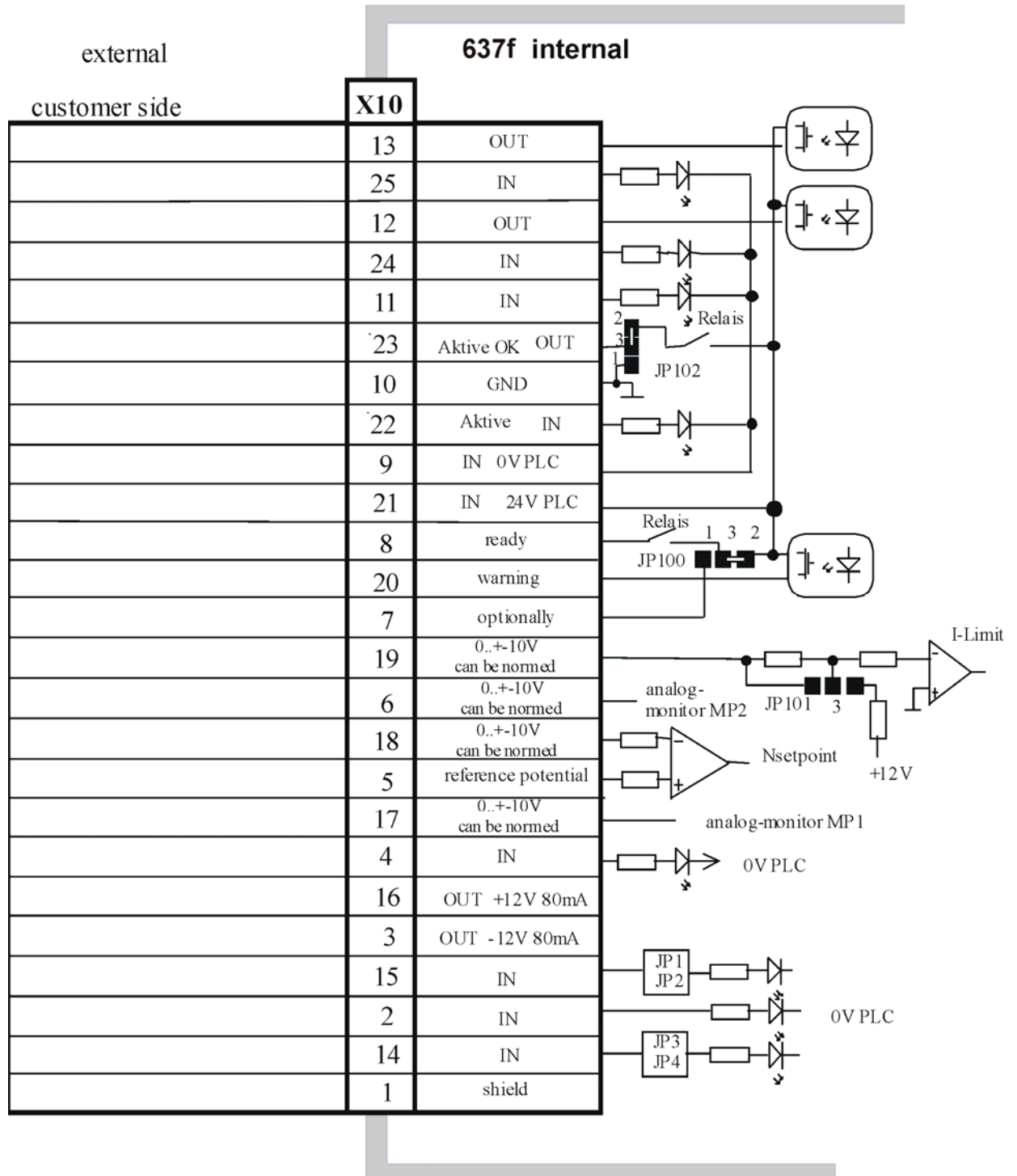

* Reference to pin 22 and pin 23:

With drives with option module SBT, kindly note the extended functions of these signals (see documentation 07-02-10-02-E-Vxxxx).

2 Connector Assignments and Functions

Connection Example (without option SBT)

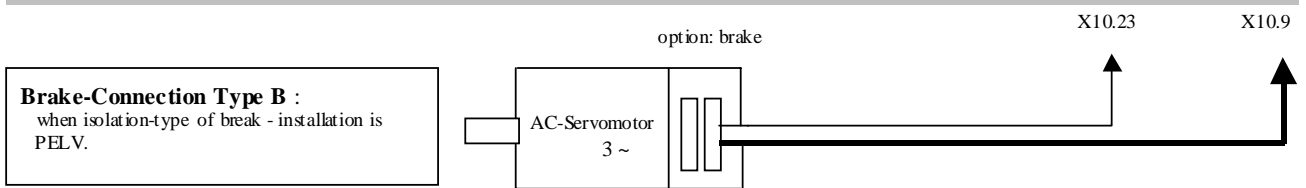
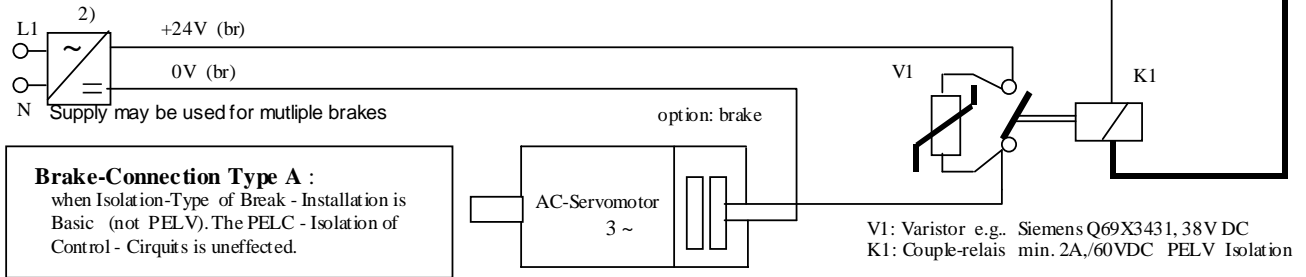
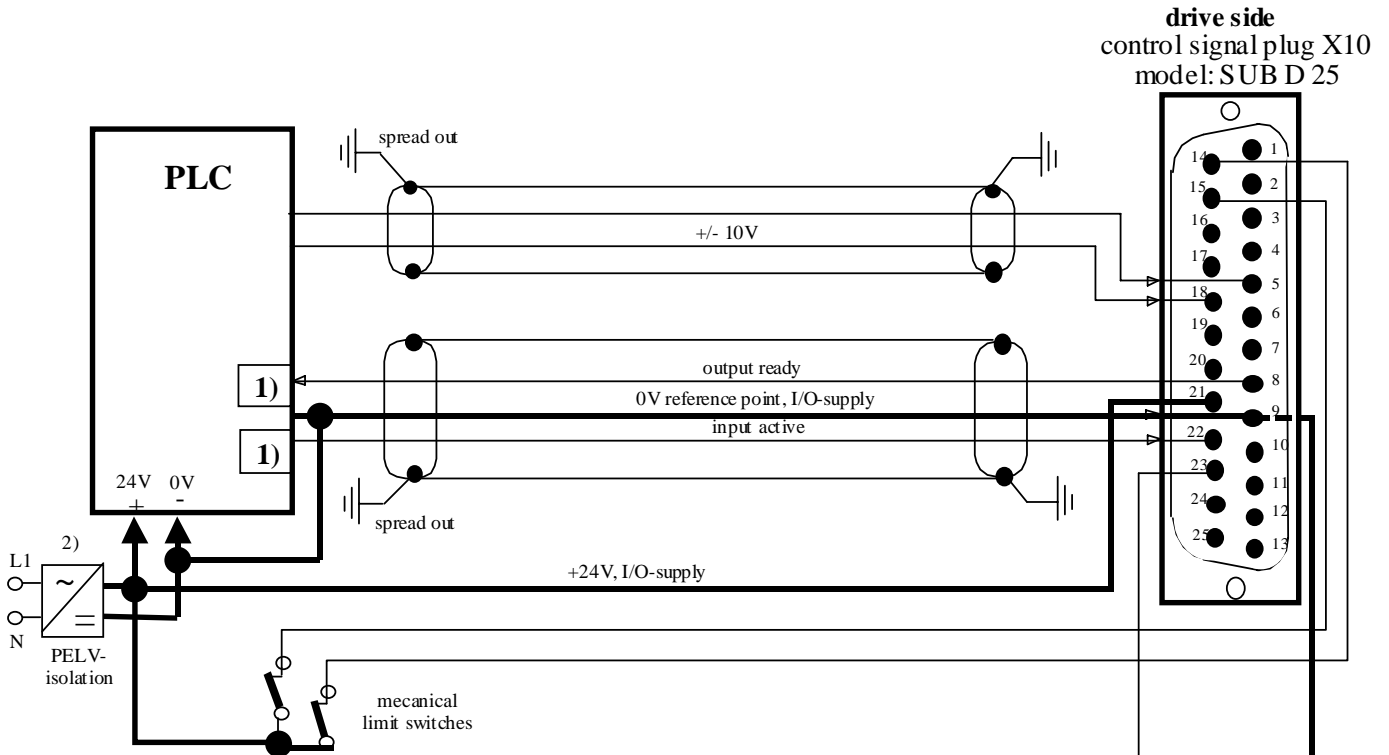

- 1) Security- and supervising logic, to be programmed by user !
- 2) **IMPORTANT:**
The power-supply for the motor-brake has to be adapted to the type of brake.
Voltage-Drops caused by long cables also may effect malfunctions of the brake.

2.3.2 Pinning Control Signal Plug X10 - SUB D25 Socket Inputs / Outputs

Control Signal Plug X10			
PIN X10	function	type	description
1	shield connector		shield
2	configurable (chapter 3)	OPTO	input
3	stabilized auxiliary voltage -12VDC; max. 80 mA		output auxiliary voltage
4	configurable (chapter 3)	OPTO	input
5	reference point to X10.18		analog input 0...+-10V Ri = 10 kOhm
6	Current monitor can be scaled in the speed drive menu		MP2 analog output, 0...+-10V
7	via JP100 (solder jumper) can be assigned as free and loopable potential of the READY contact		Optional
8	ON: drive without fault OUT: drive fault or supply voltage off	Relay	Output fixed: ready
9	Reference point for digital inputs		Reference point for digital inputs
10	Reference potential for analog signals		Ground
11	configurable (chapter 3)	OPTO	Input
12	configurable (chapter 3)	OPTO	Output
13	configurable (chapter 3)	OPTO	Output
14	configurable (chapter 3)	OPTO	Input
15	configurable (chapter 3)	OPTO	Input
16	stabilized auxiliary voltage +12V DC; max 80 mA		output auxiliary voltage
17	actual speed value monitor, scalable		MP1 analog output, 0...+-10V
18	nominal speed value; scalable differential referenced to X10.5		Analog input 0...+-10V / Ri = 10 kOhm
19	Setting of the current limit can be activated and scaled (0..+10V for 0.. I _{max})		analog input 0..+10V Ri = 10 kOhm
20	configurable (chapter 3)	OPTO	Output
21	Nominal: 24V DC		Supply for outputs
22	H = output stage is active L = output stage inactive	OPTO	input fixed: active
23	configurable (chapter 3)	Relay	output
24	configurable (chapter 3)	OPTO	input
25	configurable (chapter 3)	OPTO	input



Data of the digital inputs and outputs **see** chapter 11 General technical data

Reference to Pin 22 & Pin 23: With drives with option module SBT, kindly note the extended functions of these signals (see documentation 07-02-10-02-E-Vxxxx).

2 Connector Assignments and Functions

2.4 Feedback Sensor X30

The Feedback system generates a digital value, representing the rotor position

Derived from this value:

- commutation according to pole pair number
- actual speed value
- position value for position control

2.4.1 Function module X300

The connector X30 is directly related to the function module X300. This plug-in module (see chapter 1.4.3.1) determines the type of usable Feedback system. Thus the 637F drive system gets flexibility and is adaptable to future requirements.

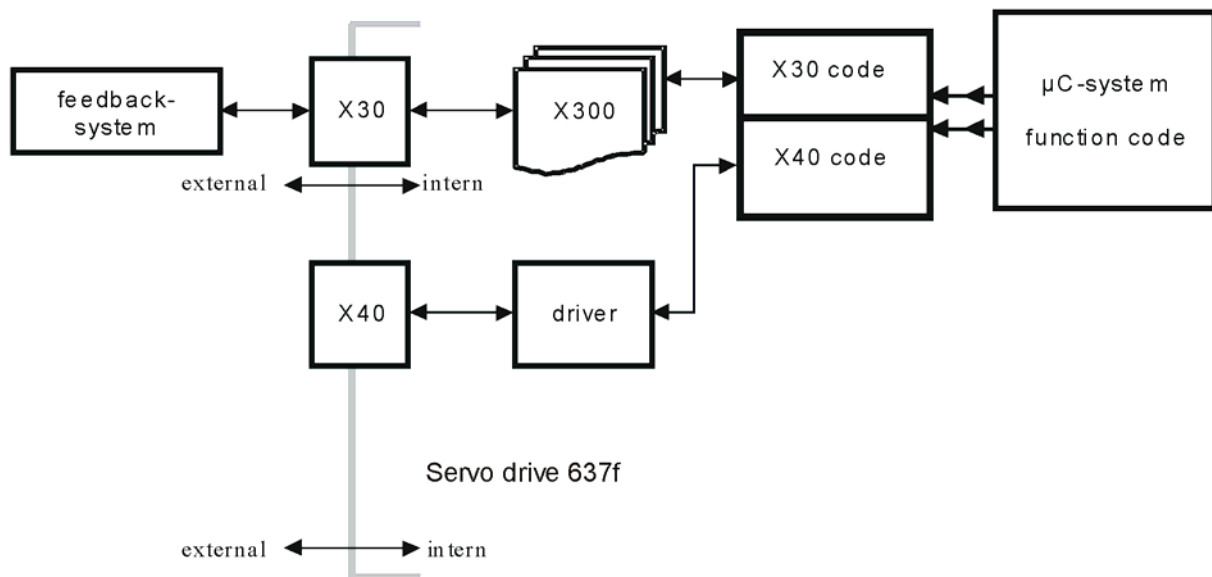

Types X300	Description	Standard / Option
X300_RD2	Resolver	Standard
X300_HF2	HIPERFACE®	Option
X300_SC2	Sinus/Cosinus	Option
Further types on request		

Plug and Play

The 637F identifies the type of the module X300.

The EASYRIDER® Windows – Software loads the correct function code.

You follow the instructions in the EASYRIDER® Windows – Software.

At function module RD2 the function code is already installed (factory default).

Note:

With application of the function module X300_HF2 (HIPERFACE®) please observe documentation 07-02-09-02-E-Vxxxx.

2.4.2 Feedback Sensor Connection X30 (SUB D 09 Socket)

Pinning of Motor - Feedback - Socket X30 with:

Resolver Module X300_RD2 (Standard Module)

Module: X300_RD2	
PIN X30	Function
1	shield
2	PTC optional
3	cos +
4	sin +
5	carrier +
6	PTC optional
7	cos -
8	sin -
9	carrier -

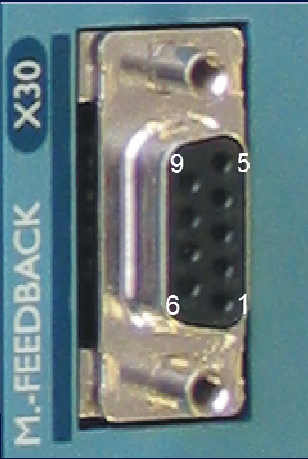

HIPERFACE® - Module X300_HF2

Module: X300_HF2	
PIN X30	Function
1	GND
2	10 VDC
3	cos +
4	sin +
5	data -
6	-
7	ref cos
8	ref sin
9	data +

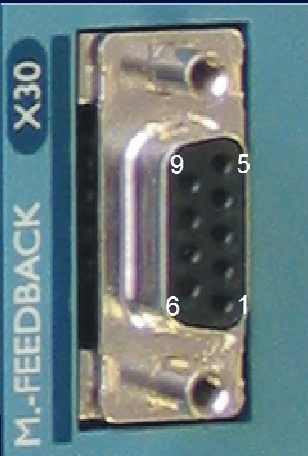

Sinus / Cosinus - Module X300_SC2

Module: X300_SC2	
PIN X30	Function
1	GND
2	5,5 V
3	cos +
4	sin +
5	zero pulse -
6	-
7	ref cos
8	ref sin
9	zero pulse +

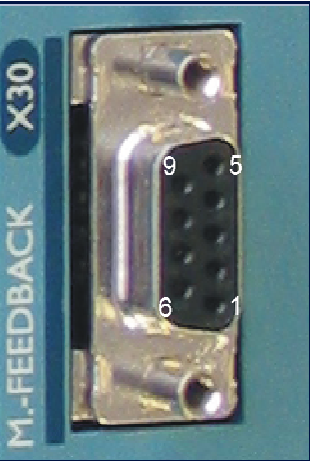

2 Connector Assignments and Functions

2.5 Multi-Function X40

Description of the X40:

Via a programmable I/O processor, the X40 connection can be configured differently.

EASYSRIDER® Windows - Software

Standard functions:

- Incremental output
- Incremental input
- Stepper motor - pulse inputs
- SSI interface

The unobstructed configurability provides ideal conditions for synchronous applications.

General Data	X40
Plug Type:	SUB D 09 male plug
Maximum Input or Output Frequency:	312 kHz
Maximum Cable Length - connected to galvanically insulated terminals (Encoder, controls)	25 m; For extended distances please contact our engineer
Maximum Cable Length - connected to ground related terminals (other drives, controls)	2 m, Pay attention to provide for good common grounding !
Maximum Number of Signal Inputs - to one as incremental output configured device	8
Output Signals:	Driver Model MAX483 or compatible, RS422
Differential Logic Level:	L \leq 0,5V H \geq 2,5V
Nominal Range:	0,0 ... 5,0V 150mA max.
Input Signals:	Receiver Model MAX481 or compatible, RS422
Differential Input Level:	Diff min = 0,2V
Nominal Signal Difference:	1,0V
Current Consumption:	1...4 mA (depending on the frequency)

Notice:

Master / Slave Operation

1 Master, Maximum 8 Slaves

Condition: Devices must be located directly side by side!

2.5.1 Incremental - Output

EASYRIDER® Windows - X40 Connection: Mode = Incremental Output

Incremental encoder simulation for processing in positioning modules

Standard: 1024 increments

Pulse Duty Cycle

Additional selectable pulse settings: 16384, 8192, 4096, 2048, 512, 256, 128, 64

Inc. I/O X40		
PIN X40	Function	Designation
1	Channel B	B
2	Channel B - Inverted	/B
3	Shield Connector	Shield
4	Channel A	A
5	Channel A - Inverted	/A
6	Reference *	GND
7	Channel Z - Inverted Zero Impulse	/Z
8	Channel Z, zero impulse	Z
9	Supply Voltage Output Max. 150 mA	+ 5 VDC



Pulse resolution	Max. permissible speed
≥1024 Incr./rpm	12000 rpm
2048 Incr./rpm	7600 rpm
4096 Incr./rpm	3800 rpm
8192 Incr./rpm	1900 rpm
16384 Incr./rpm	950 rpm

Design Rule:

The input frequency range of the connected control must equal at least the value of the pulse output frequency on the X40.

n = max. speed (rpm)
 x = increments e.g. 1024
 f = output frequency at X40.1,2,4,5

$$\text{Formula: } f = \frac{1,2 * (n * x)}{60} = [\text{Hz}]$$

Example: n = 4000 1/min

$$f = \frac{1,2 * (4000 * 1024)}{60} = 81920 \text{ Hz}$$

2.5.2 Incremental - Input

EASYRIDER® Windows - Software X40 Connection: Mode = Incremental Input

Parameter range of the input signals: 10...1000000 increments

Figure:

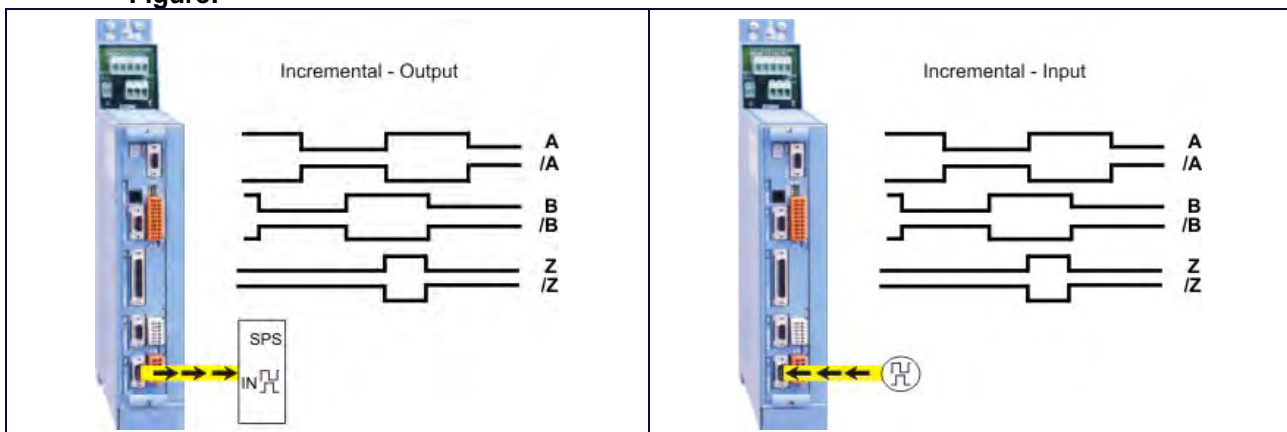

Note:

The operation of incremental encoders via long cables may cause a voltage drop of the encoder power supply. We recommend the use of a separate voltage supply if necessary.

2 Connector Assignments and Functions

2.5.3 Stepper Motor Input

Two different modes are available

EASYRIDER® Windows - Software X40 Connection: Mode = Stepper Motor (Pulse+Direction)

EASYRIDER® Windows - Software X40 Connection: Mode = Stepper Motor (2*Pulse)

INCR. I/O X40			
PIN X40	Function		Designation
	Mode: Pulse+Direction	Mode: 2*Pulse	
1	Output: Drive Active - Inverted		/READY
2	Output: Drive Active		READY
3	Shield Connector		Shield
4	Pulse Inverted	Pulse - Inverted	-
5	Pulse	Pulse -	-
6	Reference Potential (generally to connect)		GND
7	Direction Inverted	Pulse + Inverted	-
8	Direction	Pulse +	-
9	Supply Voltage Output Max. 150 mA		+5 VDC



Figure: Pulse+Direction

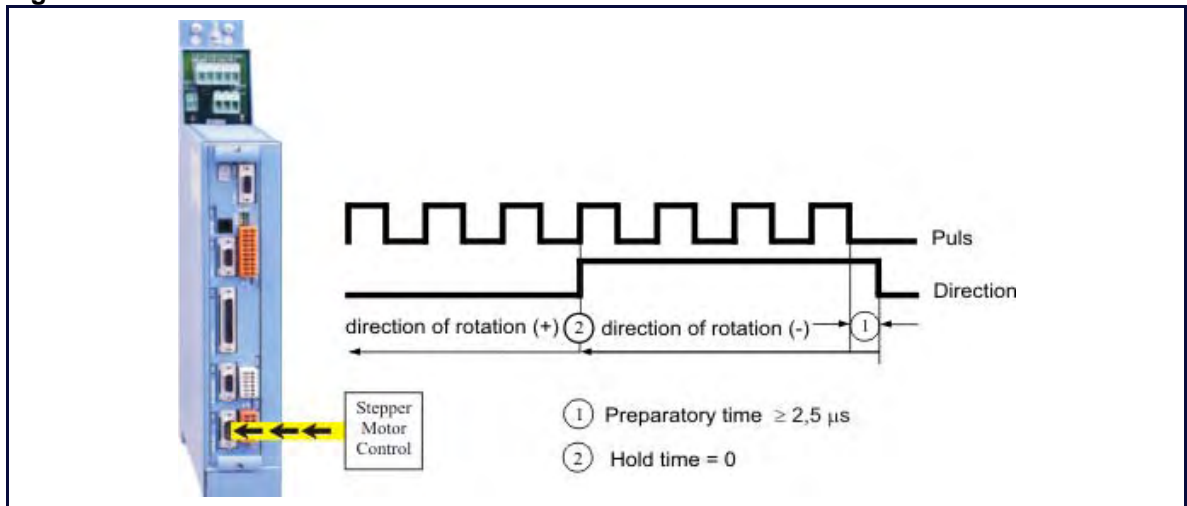
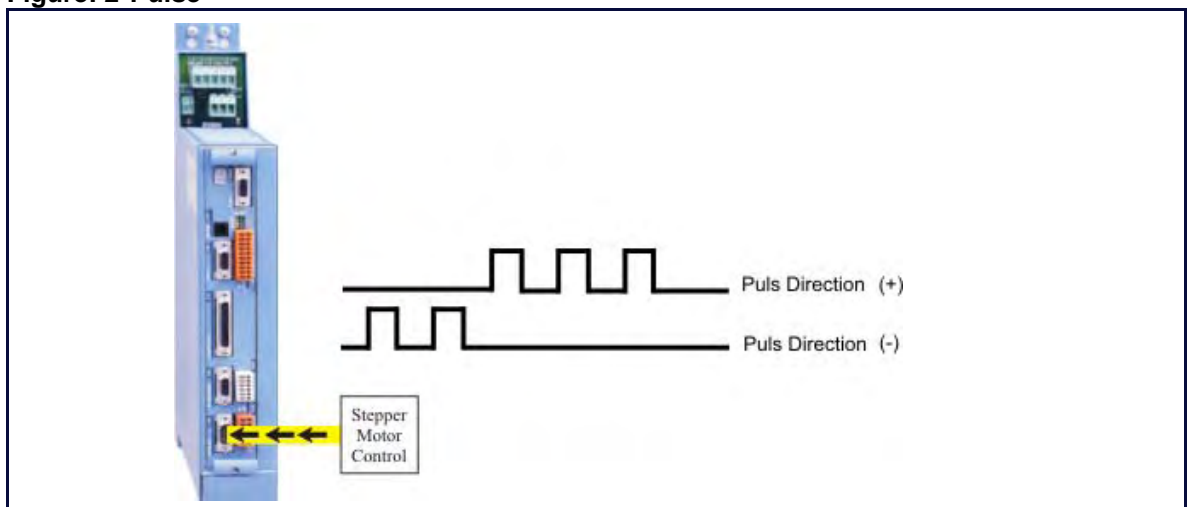

Figure: 2*Pulse



2.5.4 SSI-Encoder Interface

EASYRIDER® Windows – Software

- X40 Connection: Modus = SSI_13 Bit Singleturn Input (4)
- X40 Connection: Modus = SSI_14 Bit Singleturn Input (5)
- X40 Connection: Modus = SSI_25 Bit Multiturn Input (6) / (13 Bit Single- / 12 Bit Multiturn)
- X40 Connection: Modus = SSI_26 Bit Multiturn Input (7) / (14 Bit Single- / 12 Bit Multiturn)

Incr. I/O X40		
PIN X40	Function	Designation
1	Serial Data from SSI Encoder, GRAY Code up to 26 Bit - Inverted	/DATA
2	Serial Data from SSI Encoder, GRAY Code up to 26 Bit	DATA
3	Shield Connector	Shield
4	Clock Output - Inverted Standard Frequenzy: 179 kHz	/CLOCK
5	Clock Output Standard Frequenzy: 179 kHz	CLOCK
6	Reference Potential	GND
7	Do Not Connect	
8	Do Not Connect	
9	Supply Voltage Output Max. 150 mA If other data required: a) Use of X300 Module b) External Supply	+5 VDC



TAKT and /TAKT twisted pairs
 DATA and /DATA twisted pairs
 Cable Shielded - shielding grounded at both ends,
 Max. Cable Length: 200m

Note:

For further information about SSI (Synchronous Serial Interface), please refer to the documentation of the appropriate suppliers. (e.g.: Comp. Sick or Hengstler)

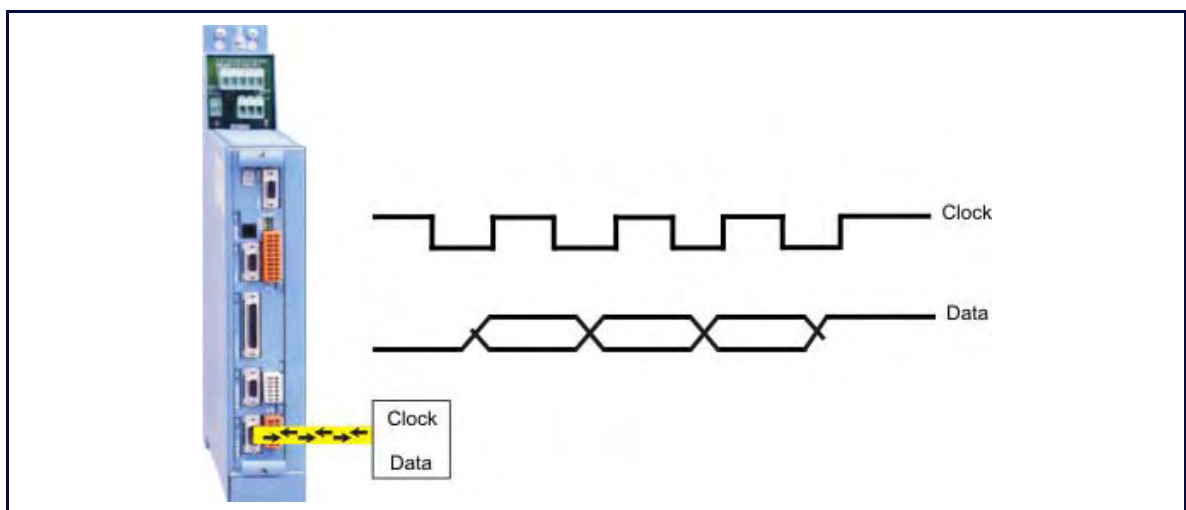

2 Connector Assignments and Functions



2.6 Digital Interfaces

2.6.1 Service Interface - COM1 (RS232)

Standard

Functions:

- Supporting all diagnosis and setup tasks
- Connection to your PC is made with the Parker communication cable KnPC/D
- Communication is made via the Parker operating program (EASYRIDER® Windows - Software)

Com 1 RS232	PIN	Function drive side	PIN	RS232 PC side
4-pin modular jack 				
RXD	1	Receive serial data	3	TXD
TXD	2	Transmit serial data	2	RXD
	3	do not connect		
GND	4	GND	5	GND

Type Code	Length	Description
Kn PC 637F / 631-03.0	3 m	PC-side, Sub D 09-plug
Kn PC 637F / 631-05.0	5 m	Drive side, 4-pin RJ 10-plug



Note:

The service interface RS232 is not galvanically isolated and should not be planned for this reason as an operating interface ("hard-wiring")!

The mains connection of the PC must be made closed to the drive, to achieve a common ground.

2.7 Fieldbus- / IO- Interface COM2

Additional functions can be realized through the optional employment of the **Options Modules**.

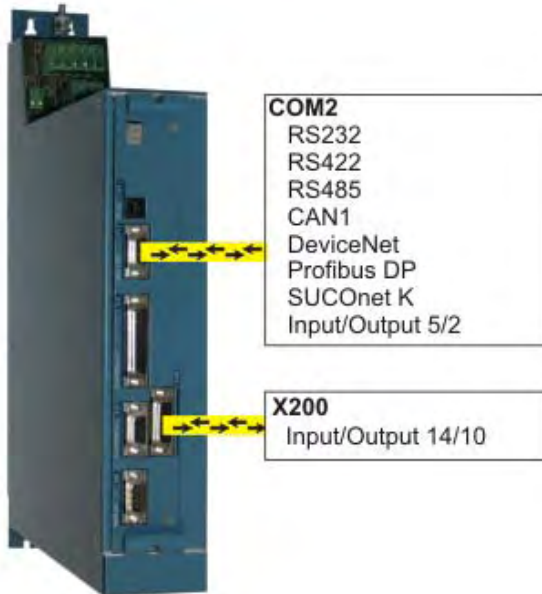

2.7.1 Pinning for RS232

Module: RP 232	
PIN	Function
1	-
2	RXD
3	TXD
4	-
5	GND
6	-
7	-
8	-
9	-



2.7.2 Pinning for RS422/485

Module: RP 422 or RP 485	
PIN	Function
1	-
2	-
3	-
4	Data In
5	GND
6	Data In - Inverted
7	Data Out - Inverted
8	Data Out
9	-



Options module **RP 422**, without galvanic separation
 Options module **RP 485**, with galvanic separation
 Parallel wiring for up to 16 units. (Full - Duplex, 4-Wire)

2 Connector Assignments and Functions

2.7.3 Pinning for CAN or DeviceNet

Module: RP CAN (CAN BUS1) or RP DEV		
PIN	Function	Designation
1	-	-
2	CAN_L Bus Line (dominant low)	CAN_L
3	Ground	CAN-GND
4	-	-
5	-	-
6	Optional Ground	CAN-GND
7	CAN_H Bus Line (dominant high)	CAN_H
8	-	-
9	-	-



with galvanic separation

2.7.4 Pinning for Profibus DP

Module: RP DP		
PIN	Function	Designation
1	-	-
2	-	-
3	Line B	B
4	Request to Send	RTS
5	Ground	PDP-GND
6	Potential +5V	+5V
7	-	-
8	Line A	A
9	-	-



with galvanic separation

2.7.5 Pinning for SUCOnet K

Module: RP SUC		
PIN	Function	Designation
1	-	-
2	-	-
3	Data Line +	TA/RA
4	-	-
5	Signal Ground	SGND
6	-	-
7	Data Line -	TB/RB
8	-	-
9	-	-



with galvanic separation

2.7.6 Pinning for EA5 - I/O-Interface (Digital In and Outputs)

Module: RP EA5			
PIN	Function	Designation	Status
1	BIAS Input 101	Standard	Input
2	BIAS Input 102	Standard	Input
3	BIAS Input 107	Standard	Input
4	BIAS Input 108	Standard	Input
5	0VSPS	Ground reference 0VSPS	B
6	BIAS Input 106	Standard	Input
7	BIAS Output 109	Standard	Output
8	BIAS Output 110	Standard	A
9	+24VSPS	Ext. +24V feed-in	UB



with galvanic separation

Notice !

The inputs with the internal numbers 107 and 108 must be connected to pin numbers 3 and 4.
The outputs with the internal numbers 109 and 110 must be connected to pin numbers 7 and 8.

2 Connector Assignments and Functions

2.7.7 Pinning for I/O-Interface X200 (14 Inputs /10 Outputs)

PIN X200	Designation	Comment	Status
1	Bias input 201	standard	input
2	Bias input 202	standard	input
3	Bias input 203	standard	input
4	Bias input 204	standard	input
5	Bias input 205	standard	input
6	Bias input 206	standard	input
7	Bias input 207	standard	input
8	Bias input 208	standard	input
9	Bias output 209	standard	output
10	Bias output 210	standard	output
11	Bias input 211	standard	input
12	Bias input 212	standard	input
13	Bias input 213	standard	input
14	Bias input 214	standard	input
15	Bias input 215	standard	input
16	Bias input 216	standard	input
17	Bias output 217	standard	output
18	Bias output 218	standard	output
19	Bias output 219	standard	output
20	Bias output 220	standard	output
21	Bias output 221	standard	output
22	Bias output 222	standard	output
23	Bias output 223	standard	output
24	Bias output 224	standard	output
25	+24 V SPS	Ext. +24 V feed-in	Ub
26	0 V SPS	Ground reference 0 V SPS	B



with galvanic separation

2.8 Fieldbus- I/O - Interface COM2 in Combination with COM3

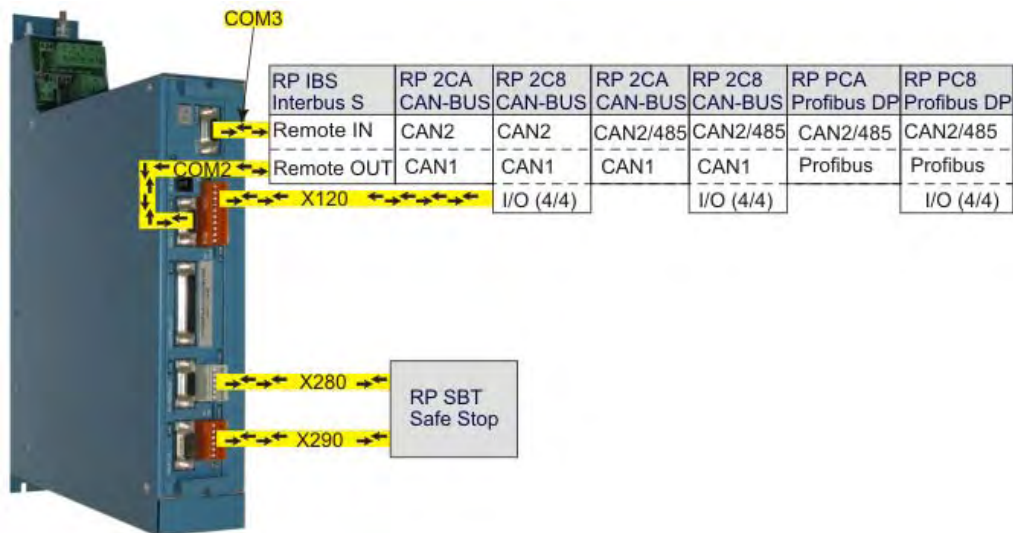

2.8.1 Pinning for Interbus S (RP IBS)

Remote OUT - Outgoing Interface (SUB D09 Socket)

Module: RP IBS		
PIN	Function	Designation
1	Data Line OUT Forward (error voltage A)	DO2
2	Data Line IN Backward (error voltage A)	DI2
3	Reference Potential	IBS-GND
4	-	-
5	VCCI	+5V
6	Data Line OUT Forward (error voltage B)	/DO2
7	Data Line IN Backward (error voltage B)	/DI2
8	-	-
9	Reporting Input *	RBST



* for additional Interbus S - Interfaces

Remote IN - Incoming Interface (SUB D09 Plug)

Module: RP IBS		
PIN	Function	Designation
1	Data Line IN Forward (error voltage A)	DO1
2	Data Line OUT Backward (error voltage A)	DI1
3	Reference Potential	IBS-GND
4	-	-
5	-	-
6	Data Line IN Forward (error voltage B)	/DO1
7	Data Line OUT Backward (error voltage B)	/DI1
8	-	-
9	-	-





with galvanic separation

2 Connector Assignments and Functions

2.9 Fieldbus-Module RP 2CA, 2C8

2.9.1 Pinning CAN1-BUS and CAN2-BUS

Module: RP 2CA, 2C8			CAN1	CAN2
PIN	Function	Designation		
1	-	-		
2	CAN_L Bus Line (dominant low)	CAN_L		
3	Ground	CAN-GND		
4	-	-		
5	-	-		
6	Optional Ground	CAN-GND		
7	CAN_H Bus Line (dominant high)	CAN_H		
8	-	-		
9	-	-		

with galvanic separation

2.9.2 Pinning RP 2C8 X120 (with I/O's)

X120	Function		BIAS PIN	Status	
	0	1			
1	BIAS	Reset Drive Fault	Input 121	Input	
2	BIAS	Limit Switch +	Input 122	Input	
3	BIAS	Limit Switch -	Input 123	Input	
4	BIAS	Reference Switch	Input 124	Input	
5	BIAS	Cam 1	Output 125	Output	
6	BIAS	Cam 2	Output 126	Output	
7	BIAS	Cam 3	Output 127	Output	
8	BIAS	Cam 4	Output 128	Output	
9	Ext. +24 V Supply		-	Ub	
10	Ground Reference 0 V		-	B	

The signal status of the I/O's is shown with a 2mm LED
 LED on I/O = high / LED off I/O = low.
 (min./max. cable cross-section: 0,08mm² / 1,5mm²)

2.9.2.1 DIL Schalter Stellung für Optionsmodul RP 2CA und RP 2C8

DIL – switch position

<p>Default = all off</p>																											
2^0 ----- 2^6	2^0 ----- 2^2	2^2 2^1 2^0	<table border="1"> <tr><td>0 0 0</td><td>0</td><td>20 kBaud</td></tr> <tr><td>0 0 1</td><td>1</td><td>50 kBaud</td></tr> <tr><td>0 1 0</td><td>2</td><td>100 kBaud</td></tr> <tr><td>0 1 1</td><td>3</td><td>125 kBaud</td></tr> <tr><td>1 0 0</td><td>4</td><td>250 kBaud</td></tr> <tr><td>1 0 1</td><td>5</td><td>500 kBaud</td></tr> <tr><td>1 1 0</td><td>6</td><td>800 kBaud</td></tr> <tr><td>1 1 1</td><td>7</td><td>1000 kBaud (1MBaud)</td></tr> </table>	0 0 0	0	20 kBaud	0 0 1	1	50 kBaud	0 1 0	2	100 kBaud	0 1 1	3	125 kBaud	1 0 0	4	250 kBaud	1 0 1	5	500 kBaud	1 1 0	6	800 kBaud	1 1 1	7	1000 kBaud (1MBaud)
0 0 0	0	20 kBaud																									
0 0 1	1	50 kBaud																									
0 1 0	2	100 kBaud																									
0 1 1	3	125 kBaud																									
1 0 0	4	250 kBaud																									
1 0 1	5	500 kBaud																									
1 1 0	6	800 kBaud																									
1 1 1	7	1000 kBaud (1MBaud)																									
<p>Note number 0 - 127</p>		<p>Baud rate</p>																									
<p>Example: Node Number 5; 1MBaud</p>																											



DIL – switch position **bus termination**

<p>COM2</p>	<p>COM3</p>	<p>Default</p>	<p>COM2/COM3</p>

2 Connector Assignments and Functions

2.10 Fieldbus Module RP CCA, RP CC8

2.10.1 Pinning CAN1-BUS, CAN2-BUS and RS485

Modul: RP CCA, CC8			CAN1 BUS	
PIN	Function	Designation		
1	-	-		
2	CAN_L Bus Line (dominant low)	CAN_L		
3	Ground	CAN-GND		
4	-	-		
5	-	-		
6	Optional Ground	CAN-GND		
7	CAN_H Bus Line (dominant high)	CAN_H		
8	-	-		
9	-	-		
CAN2			CAN2 BUS / RS485	
RS485				
1	-	Data-IN inv.		
2	CAN_L Bus Line (dominant low)	-		
3	Ground	485-/CAN-GND		
4	-	DATA-IN		
5	-	GND (optional)		
6	Ground	485-/CAN-GND		
7	CAN_H Bus Line (dominant high)	-		
8	-	Data-OUT		
9	-	Data-OUT inv.		

with galvanic separation

2.10.2 Pinning RP CC8 X120 (with I/O's)

X120	Function		BIAS PIN	Status	I/O's
	0	1			
1	BIAS	Reset Drive Fault	Input 121	Input	
2	BIAS	Limit Switch +	Input 122	Input	
3	BIAS	Limit Switch -	Input 123	Input	
4	BIAS	Reference Switch	Input 124	Input	
5	BIAS	Cam 1	Output 125	Output	
6	BIAS	Cam 2	Output 126	Output	
7	BIAS	Cam 3	Output 127	Output	
8	BIAS	Cam 4	Output 128	Output	
9	Ext. +24 V Supply		-	Ub	
10	Ground Reference 0 V		-	B	

The signal status of the I/O's is shown with a 2mm LED
 LED on I/O = high / LED off I/O = low.
 (min./max. cable cross-section: 0,08mm² / 1,5mm²)

2.10.3 DIP Switch Position for Option Module RP CCA and RP CC8

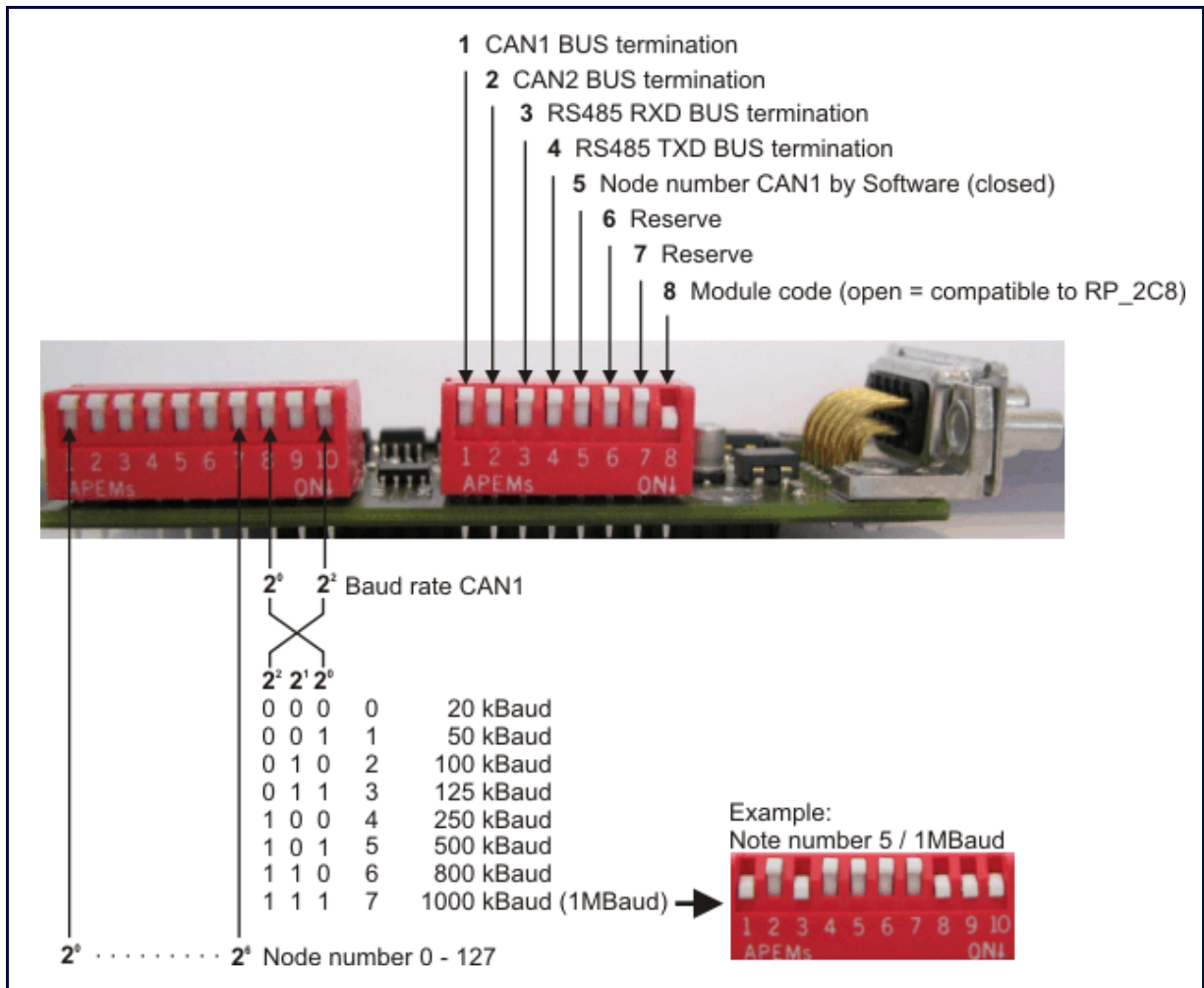

DIP – Switch Position CAN



2 Connector Assignments and Functions

2.11 Fieldbus Module RP PCA, RP PC8

2.11.1 Pinning Profibus DP, CAN2-BUS and RS485

Module: RP PCA, PC8			Profibus DP	
PIN	Function	Designation		
1	-	-		
2	-	-		
3	Line B	B		
4	Request to Send	RTS		
5	Ground	PDP-GND		
6	Potential +5V	+5V		
7	-	-		
8	Line A	A		
9	-	-		
CAN2		RS485	CAN2-BUS / RS485	
1	-	Data-IN inv.		
2	CAN_L Bus Line (dominant low)	-		
3	Ground	485-/CAN-GND		
4	-	DATA-IN		
5	-	GND (optional)		
6	Ground	485-/CAN-GND		
7	CAN_H Bus Line (dominant high)	-		
8	-	Data-OUT		
9	-	Data-OUT inv.		

with galvanic separation

2.11.2 Pinning RP PC8 X120 (mit E/A's)

X120	Function		BIAS PIN	Status	I/O's
	0	1			
1	BIAS	Reset Drive Fault	Input 121	Input	
2	BIAS	Limit Switch +	Input 122	Input	
3	BIAS	Limit Switch -	Input 123	Input	
4	BIAS	Reference Switch	Input 124	Input	
5	BIAS	Cam 1	Output 125	Output	
6	BIAS	Cam 2	Output 126	Output	
7	BIAS	Cam 3	Output 127	Output	
8	BIAS	Cam 4	Output 128	Output	
9	Ext. +24 V Supply		-	Ub	
10	Ground Reference 0 V		-	B	

The signal status of the I/O's is shown with a 2mm LED
 LED on I/O = high / LED off I/O = low.
 (min./max. cable cross-section: 0,08mm² / 1,5mm²)

2.11.3 DIP Switch Position for Option Module RP PCA, PC8

DIP – Switch Position **CAN2 / RS485** and Profibus DP

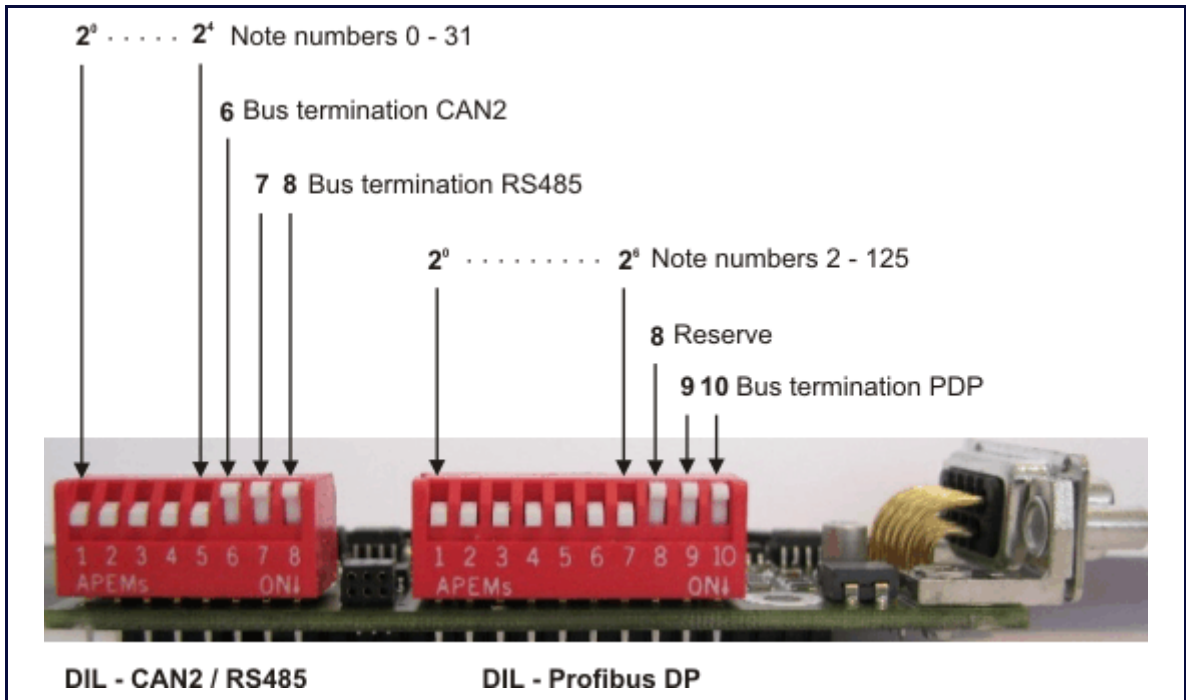

Further information for the Profibus DP: See Documentation 07-05-04-02-E-Vxxxx.

2 Connector Assignments and Functions

2.12 Option module RP SBT

2.12.1 Safe Stop

Connector assignment X290:

PIN X290	designation	comment	status
1	Input Active	¹⁾ OPTO	Input
2	Reference point Input Active	OPTO	Input
3	Starting lockout deactivated	Relais	Input
4	Reference point Starting lockout	Relais	Input
5	Checkback contact	Free contact	Break contact
6	Checkback contact	Free contact	Break contact



Reference:

- ¹⁾ With employment the option module RP SBT changes the function "AKTIV" from the connecting plug X10.22 after X290.1! The input X10.22 can be used then as free programmable input (BIAS).

Use of the function Safe Stop

The option RP_SBT of the drive controller 637Fxxx supports the safety function "Safe Stop", protection against unexpected starting, according to the requirements of the EN954-1 "Category 3" and EN1037. The stop of the machine must be caused and guaranteed before by the external machine control. This applies in particular to vertical axes without selflocking mechanics or counterweight. If an error arises in the drive system during the active brake phase, the axis can coast down uncontrolled or even accelerate actively.

In order to use the Starting lockout function intended, it is to be looped into the net contactor circle or emergency stop circle with the obligation-led reporting contact X290.5/6. With not plausible functioning of the Starting lockout relay, related to the operating mode of the machine, a galvanic separation of the drive concerned from the net must take place. The Starting lockout and the associated mode may be used again only after error correction.

Due to a danger analysis / view of risk (to be accomplished according to machine guideline 89/392/EWG and/or EN 292; EN 954 and EN 1050) the machine manufacturer must project the safety circuit of its machine types for the **entire machine** including all integrated components (also the electric drives).

Block diagram:

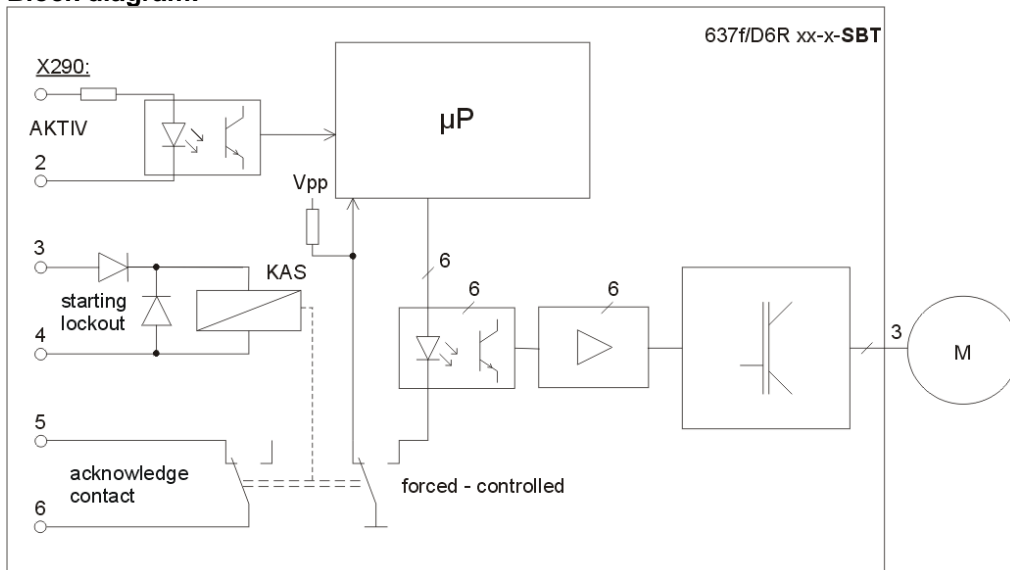

2.12.2 Brake control and PTC evaluation

Connector assignment X280

PIN X280	designation	status
1	Supply for brake output and PTC evaluation	Input
2	Reference point for supply	Input
3	Reference point for Brake control	Output
4	Brake control Active ok.	Relais output
5	PTC	Input
6	PTC	Input



Use of the Brake control

The relay output X280.3 serves for the control of holding brakes. This output is functionally identical

to the output X10.23. The output at X280.3 has the following advantages over X10.23:

The isolation relay contact → control electronics corresponds to the basis isolation. I.e. also brake installations (which correspond to the basis isolation) without interface relays, while maintaining the PELV isolation (double) of the drive controller are operated (see X10 connection example chapter 2.3.2)

The brake control possesses an active clamping of over voltages between the two brake connections.

Stronger dimensioning of the brake contact.

Use of the PTC evaluation

The PTC connection serves for the monitoring of the engine temperature. In its function mode it is identical to the port X30.2/6. The following advantage exists over X30.2/6 :

The isolation evaluation circle → control electronics corresponds to the basis isolation. I.e. also PTC thermistors (which correspond to the basis isolation) can be evaluated, without waiving the safe separation to the control electronics.

Block diagram / Connector assignment

Circuit diagram

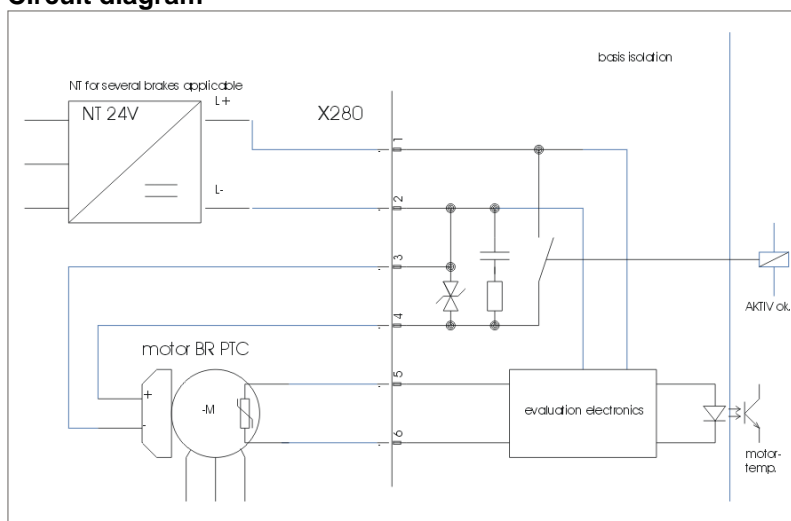

Further details see product manual **07-02-10-02-E-V..**

3 Operating Mode

The preselection of the device functions are carried out by choosing the operating modes 0...5 according to the following table, **see chapter 3.1**, (EASYRIDER® Windows - Software).

Each operating mode allows the assignment of different in- and output functions (F0..F6).

Operating mode	Reference-source	Hints for selecting the operating
0 1 2	analog (X10.5/18)	switchable the operating modes 1 and 2 by input X10.24 speed control analog torque controller analog
3	analog (X10.5/18) / digital	simple applications with requirement of switching between position and speed control position controller (input X10.24) handling like operating mode 4
4	digital or analog in acc. to parameter set	general position-controlled systems. Up to 10 positions can be stored under identifier-numbers and activated like shown.
pos. selection (Nr. 0...9)	function F2 data $2^0...2^4$	<p>The diagram shows a sequence of digital signals over time. A signal labeled 'pos. selection' changes from low to high. This is followed by 'input start' going high. A shaded rectangular area represents the 'axis move to selected position-number'. After the move, 'output position reached' goes high. Time intervals t_1 and t_2 are marked at the bottom, corresponding to the start and end of the move phase.</p>
input start	function F2 X10.2	
axis move to selected position-number		
output position reached	function F0 X10.12	
$t_1 = 2\text{ms minimum}$	$t_2 = 2\text{ms minimum}$	
5	digital or analog in acc. to programming or via digital communication (e.g. fieldbus)	simple to complex systems using instructions BIAS (up to 1500 command blocks) PLC - functions for further information: see chapter 13.1 and 13.2

3.1 Operating Modes and pin functions

Available pins number	Operating Modes					
	0	1	2	3	4	5
	torque / speed-control	speed control	torque control	position / speed-control	position control	position control + BIAS functions
input X10.14	F0, F1	F0, F1	F0, F1	F0, F1, F2, F3	F0, F1, F2, F3, F6	F0, F1, F2, F6
input X10.15	F0, F1	F0, F1	F0, F1	F0, F1, F2, F3	F0, F1, F2, F3, F6	F0, F1, F2, F6
input X10.4	---	---	---	---	F2, F6	F0, F2, F3, F6
input X10.25	---	---	---	---	F2, F6	F0, F2, F3, F6
input X10.11	F1	F1	F1	F1	F1, F2, F6	F0, F1, F2, F3, F6
input X10.24	F0 L = torque- H = speed control	---	---	F0 L = torque- H = speed control	F1, F2, F6	F1, F2, F3, F6
input X10.2	---	---	---	---	F0	F2, F3

output X10.12	F0, F2, F5	F0, F2, F5	F0, F2, F5	F0, F1, F3, F5	F0, F1, F3, F5	F0, F1, F2, F3, F4, F5
output X10.13	F0, F2, F5	F0, F2, F5	F0, F2, F5	F0, F1, F3, F5	F0, F1, F3, F5	F0, F1, F2, F3, F4, F5
output X10.20	F0, F2, F5	F0, F2, F5	F0, F2, F5	F0, F1, F3, F5	F0, F1, F3, F5	F0, F1, F2, F3, F4, F5
output X10.23	F0, F2, F5	F0, F2, F5	F0, F2, F5	F0, F1, F3, F5	F0, F1, F3, F5	F0, F1, F2, F3, F4, F5

The assignment of the functions F0..F5 is listed in the following table

3 Operating Mode

3.2 Configurable pin-functions (depending on the operating mode)

Input functions (depending on the operating modes)							
input Nr.	function F0	function F1	function F2	function F3	function F4	function F5	function F6 ²⁾
input X10.14	☒	3) limit switch +	1) set selection data 2 ⁰	move manually +	☒	☒	CAN Node no. 2 ⁰
input X10.15	☒	3) limit switch -	1) set selection data 2 ^a	move manually -	☒	☒	CAN Node no. 2 ^a
input X10.4	latch input 1 ⤴	extended latch	1) set selection data 2 ^b	☒	☒	☒	CAN Node no. 2 ^b
input X10.25	latch input 2 ⤴	☒	1) set selection data 2 ^c	☒	☒	☒	CAN Node no. 2 ^c
input X10.11	start (slope 0-->1) for BIAS - move commands	3) drive trouble reset	1) set selection data 2 ^d	☒	☒	☒	CAN Node no. 2 ^d
input X10.24	operating mode selection (0) – 1 or 2 (3) – 1 or 4	3) reference sensor	1) set selection data 2 ^{max}	☒	☒	☒	CAN Node no. 2 ^{max}
input X10.2	start (slope 0-->1) with position set selection in position control (4)	☒	strobe (slope 0-->1) for BIAS-set selection	☒	☒	☒	☒

output X10.12	position reached	reference output	☒	tracking window exceeded	synchron-format trigger	non drive trouble	-
output X10.13	temperature monitoring	reference output	☒	tracking window exceeded	start offset trigger	non drive trouble	-
output X10.20	warning	reference output	☒	tracking window exceeded	☒	non drive trouble	-
output X10.23	active ok (motor brake)	reference output	☒	tracking window exceeded	☒	non drive trouble	-



BIAS-function, free programmable.(in operating mode 5) resp. no function in operating mode 0 at 4.



fast input for optimal timing

1) With every row (from the top to the bottom) in which the function F2 is assigned to an input, the binary

value (2ⁿ) increases by 1. (see example)

Operating mode 4: only permissible set number 0 - 9 !

2) only possible with module RP-CAN.

3) Is the Option RP 2C8 (chapter. 2.6.2.12) insertion, are the contact function as the same definition on X10-plug invalid (the inputs can freely programmable and use in BIAS program)

3.3 Functions Diagrams with Protection Mode “Switch Off”

In accordance with EASYRIDER® Windows – Software “Commissioning / Motor / Motor/30”

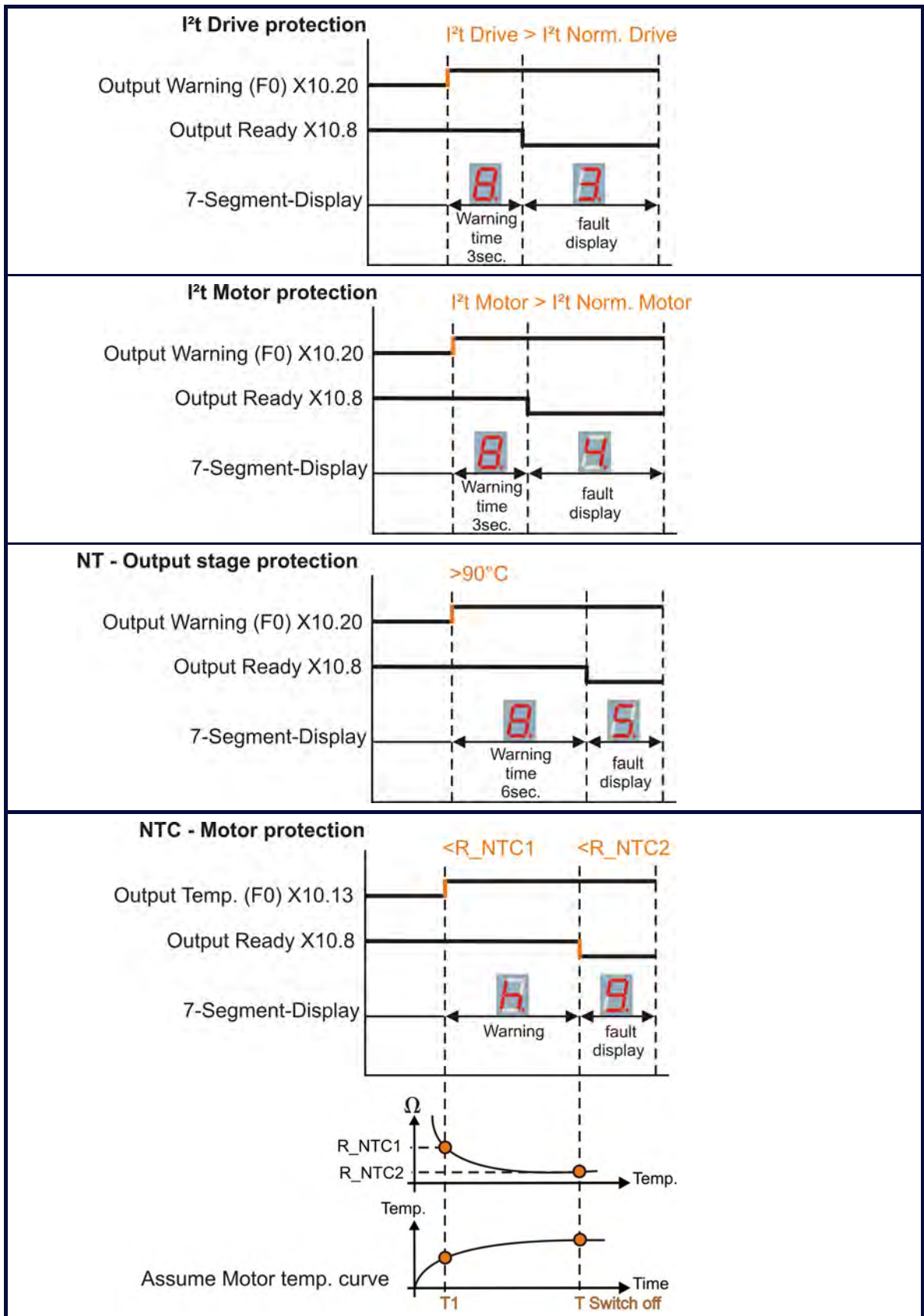

3 Operating Mode

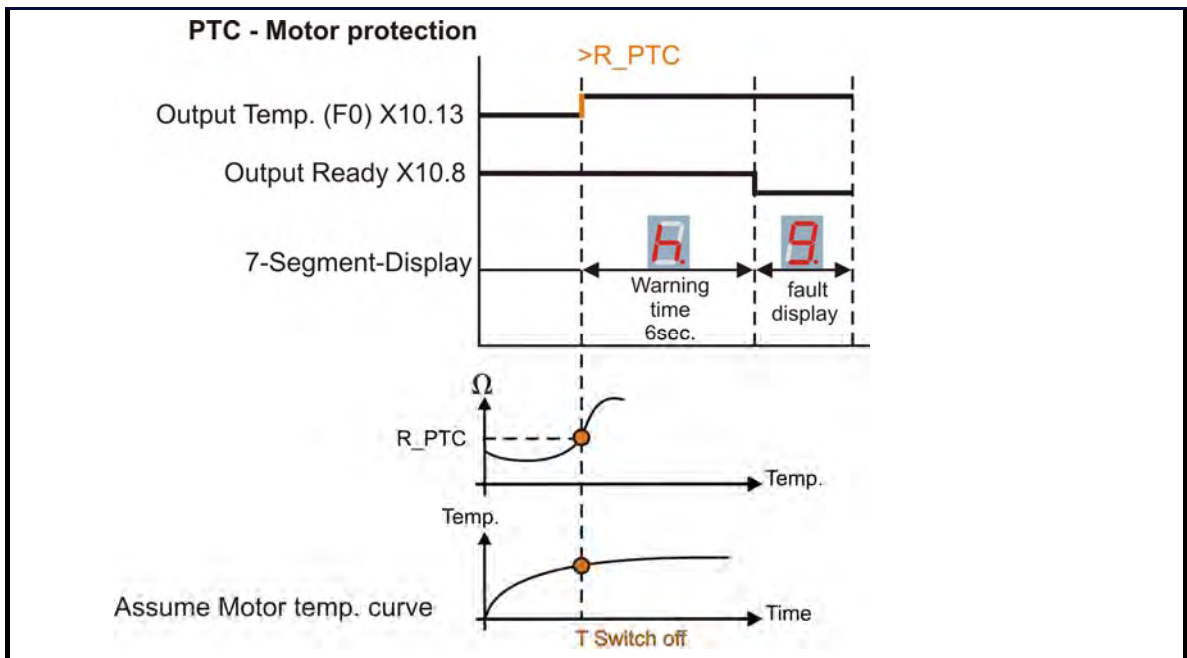

Hint:

With the assembly of the option module SBT you kindly note the extended functions of the signals (see documentation 07-02-10-02-E..)

4.1 Mounting

Parker digital servo drives may be installed only in a vertical position to guarantee the best air circulation for the cooling ribs of the heat sink. Vertical installation above other drive racks or above other heat producing devices can lead to overheating. In addition the drives are to be operated exclusively in Parker racks or the compact enclosure respectively.

4.2 Control cabinet - mounting

Installation should be carried out only in a control cabinet in which the inside must be free from dust, corrosive fumes, gases and all liquids.

Make absolutely sure that the condensing of evaporating liquids including atmospheric moisture is avoided. Should the digital servo drive be installed in a place where condensation is likely, a suitable anticondensation heater must be installed. The heater must be SWITCHED OFF during normal operation. Automatic switch off is recommended

Parker-digital servo drives should not be installed in areas which have been classified as dangerous, if they have not been installed in an approved enclosure in accordance with regulations and checked.

Make sure, there is enough cooling and space ! (see sketch)

- only horizontal !
- on the side
no distance is required

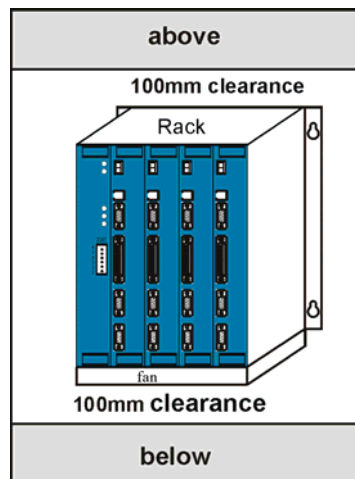

General rule:

It is better to place heat-producing devices low in an enclosure to support internal convection and to spread the heat. If placing such devices up high is unavoidable, enlarging the upper dimensions at the expense of height or installing fans should be considered.

4.3 Cooling

The digital servo drives are protected against damages caused by overheating. There is a thermal sensor installed on the heat sink. When the temperature rises to $>95^{\circ}\text{C}$, the drive is automatically switched off. This setting cannot be changed. Make sure a cabinet of proper size is selected for adequate air circulation

If the device becomes operated in a not ventilated device, the case volume of the specified control cabinet must be calculated in accordance with the following table !

Units	Volume of cabinet
637F0D6R02...D6R10	0,12 m ³
637F0D6R16...D6R30	0,25 m ³

For more exact information, please, address to the control-cabinet manufacture

5 Electrical Installation

5.1 Safety

The voltages carried by power supply cables, motor cables, connectors, and certain parts of the drive can cause serious electric shocks and even death

5.2 The danger of electric shocks



Caution !

Risk of electrical shock, wait 3 minutes after switching off, for discharging the capacitors. Disconnect Parker plug-in units from mains before working on them. A period of **three** minutes **must** pass after switching off so that the internal capacitors can discharge completely. Until the discharge time is over, there can be dangerous voltages in the module ! Persons, which monitoring or carrying out electrical installation and maintenance must be adequately qualified and schooled in these activities.

5.3 Danger areas

The use of variable speed drives of all kinds can invalidate the certification for dangerous areas (apparatus group and/or temperature class) of explosion-protected motors. Inspection and certification for the complete installation of servo motors and electronic components **must** be obtained.

5.4 Grounding, safety grounding

The grounding impedance must meet the requirements of local industrial safety regulations and should be inspected and checked at appropriate and regular intervals

5.4.1 Ground connections

It is recommended to attach a ground bus of high conductivity copper as near as possible to the servo-rack or drive modules in order to minimize the length of the cable connections. The recommended dimensions are:

Thickness: $d = 5$ to 6 mm

Length (m)	Width (mm)
$< 0,5$	20
$0,5 < 1,0$	40
$1,0 < 1,5$	50

The diagram shows a 3D perspective of a rectangular grounding bus-bar. The length is labeled 'l', the width is labeled 'b', and the thickness is labeled 'd'. The text 'grounding bus-bar' is centered on the top surface of the bar.

Ways of raised discharge currents $> DC 10mA$ resp. $> AC 3,5mA$ the PE-Bolt of the drive has to be connected to PE using copper-cable minimum $10mm^2$!

5.5 Short-circuit capability and discharge currents

Due to the working-principle of servo drives there may discharge currents to PE exceeding DC $10mA$ resp. AC $3,5mA$. Suitable for use on a circuit capable of delivery not more than 5000 RMS symmetrical amperes 505V maximum. (Note according to UL508C)

5.6 Fuses, contactors, filters

Compact units		637F	KD6R02		KD6R04		KD6R06		KD6R10		KD6R165	KD6R22	KD6R30	
			-3	-7	-3	-7	-3	-7	-3	-7	-7	-7	-7	
Fuses, Contactors	4)													
RCD-switch		not recommended. Required setpoint: 300 mA, no protection against life danger												
mains input currents		[A]	3,5	5	7,5	12	19	26	30					
mains protection	1)	Type	T10A		T10A		T10A		T20A		T25A		(T32A) 35A	(T32A) 35A
protector-switch	2)	Type	PKZM0-16		PKZM0-16		PKZM0-16		PKZM0-16		PKZM0-25		PKZ2/ZM32	PKZ2/ZM32
mains fuse	2)	Type	DIL 00M		DIL 00M		DIL 00M		DIL 00M		DIL 0M		DIL 0M	DIL 0M
Line filters	4)													
general		only for use in earth referenced supplies(TN). Current drain to PE !												
		single-phase												
maximum motor cable length 50m	5)	Type	LNF E 1*230/012 up to AC 230V !! + ferrite core						not possible !					
maximum motor cable length 20m	6)	Type	LNF E 1*230/012 up to AC 230V !! + ferrite core						not possible !					
		3-phasig												
maximum motor cable length 50m	5)	Type	LNF B 3*480/008 + ferrite core FR 3				LNF B 3*480/018 + ferrite core FR 6				LNF B 3*480/033 + ferrite core FR 6			
maximum motor cable length 20m	5)	Type	LNF B 3*480/008 + ferrite core FR 3				LNF B 3*480/018 + ferrite core FR 3				LNF B 3*480/033 + ferrite core FR 3			
		3-phasen, max. 3 Units, supplied by a common filter												
maximum motor cable length 20m	5)	Type	LNF B *480/082 + ferrite core FR6 other types upon request (according to ref.measurements with 3 units, supplied by common line)											
maximum motor cable length 20m	6) 3)	Type	LNF B 3*480/018; LNF B *480/033, LNF B *480/046, LNF B *480/060 + ferrite core FR6 other types upon request (according to ref.measurements with 3 units, supplied by common line)											

Plug-in modules		637F	0D6R02		0D6R04		0D6R06		0D6R10		0D6R16		0D6R22		0D6R30	
			-3	-7	-3	-7	-3	-7	-3	-7	-3	-7	-3	-7	-3	-7
Fuses, contactors, filters	4) 1)															
general		Orientation: Table for compact units and the addition of rated currents of used units on the DC-Bus. Depending on the application, energy sharing effects by DC-link may reduce the required supply current considerable.														
fuses		Rule of the thumb: single-phase operation: 2...3 times of added rated currents Rule of the thumb: 3-phase operation: 1,5...2 times of added rated currents														
peak making currents		Depending on power-supply unit, limiting equipment is required (delay contactor)														
filters		only for use in earth referenced supplies(TN). Current drain to PE !														
filter types		Orientation: Table of compact units. Further types: see separate manual														

- 1) recommended for UL-requirements: Bussmann Type FRS-R, 600V, use only UL-approved fuse-holders !
- 2) recommended, Klöckner Moeller for instance
- 3) Measurement of conducted emissions only
- 4) for applications with continuous load: see notes in chapter 5.7
- 5) EN61800-3 First Environment, unrestricted distribution: Category C1 (basic specification EN55011)
- 6) EN61800-3 First Environment, restricted distribution: Category C1 (basic specification EN55011)

5 Electrical Installation

5.7 Correction of supply current

Attention in case of continuous load:

Due to the capacitive input impedance of DC-Bus, the input current is deformed.

This guides to RMS -values higher than the sinus-based calculated values. Fuses, contactors and line filters have to be selected in respect to this effect.

In typical servo application with Stop/Go-operation (S3-Operation), the rating to nominal data will be sufficient.

In other cases, the value has to be corrected using the following diagram.

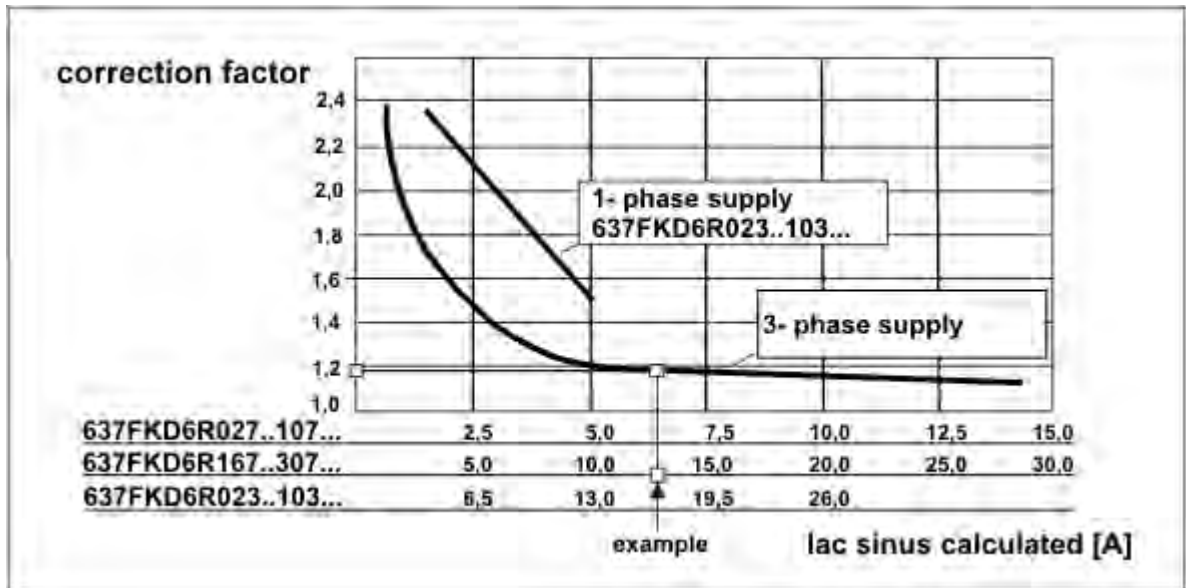

Example:

Drive type 637FKD6R167 is supplied by AC 230V 3-ph.

Output-power: $P_{out} = 200V \cdot 16A \cdot 1,73 = 5,54 \text{ kW}$

This output-power must be generated by:

Calculated supply-current $I_{ac \text{ sinus}} = 5,54 \text{ kW} / (230V \cdot 1,73) = 13,9 \text{ A}$

Correction-Factor from diagram: 1,19

RMS. Supply-Current $I_{eff} = I_{ac \text{ sinus}} \cdot 1,19 = 16,5 \text{ A}$

Result:

All supply-equipment has to be selected in respect to the enhanced current.

5.8 Brake resistor

5.8.1 Selection of the brake resistor

The energy of a moving system flows back to the Drive. The DC-Bus capacitors are able to take a small value. The rest has to be converted to heat by a resistor. Switching of this brake resistor depends on the DC-Bus voltage. The load of the resistor is simulated and supervised electronically (EASYSRIDER® Windows - Software). Peak power (Pmax) and continuous power (Pd) ratings have to be sufficient to meet the requirements of the application.

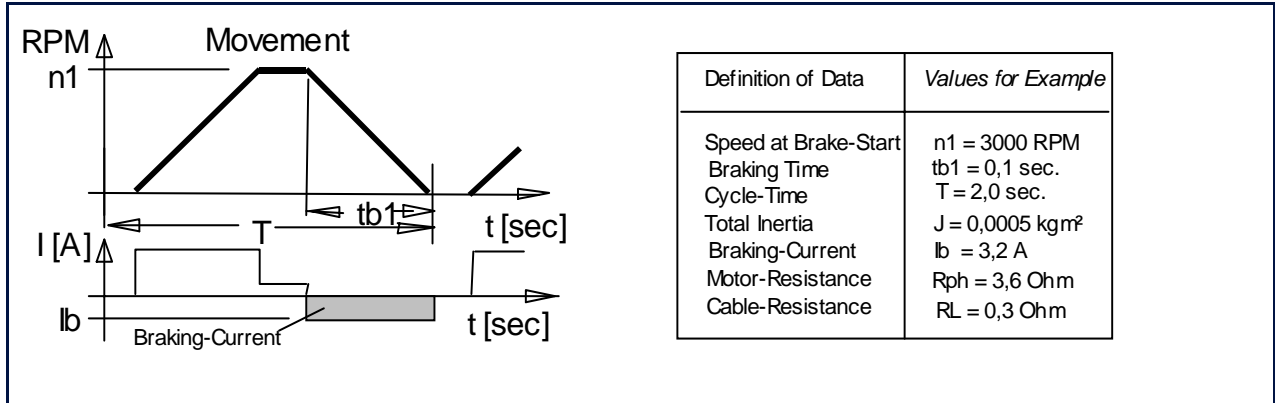

Calculation	
Step 1	example
Calculation of brake-power (Approximation. Capacitor-load, friction-and drive-losses neglected)	
Power of motion: Pkin = 0,0055 * J * n1² / tb1 [W]	$P_{kin} = 0,0055 * 0,0005 * 3000^2 / 0,1$ Pkin = 247 W
Motor-losses: Pvmot = lb² * (Ri + RL) [W]	$P_{vmot} = 3,2^2 * (3,6 + 0,3)$ Pvmot = 40 W
Cont. Power: Pd = 0,9 * (Pkin - Pvmot) * tb1 / T [W]	$P_d = 0,9 * (247 - 40) * 0,1 / 2$ Pd = 9,3 W
Peak-Power: Pmax = (1,8 * Pkin) - Pvmot [W]	$P_{max} = (1,8 * 247) - 40$ Pmax = 405 W
used units: J total inertia [kgm²] n1 speed at Brake-Start [RPM] tb1 braking time [Sec] T cykle time [Sec] lb brake-current [A] Rph resistance of motor (between terminals) [Ω] RL line resistance of motor cable [Ω]	

5 Electrical Installation

Step 2 Internal / external Brake-resistor required ? see data in chapter 1.3.3 / 1.3.4	Example-Drive type 637FKD6R047																																						
In case of insufficient capability or not included internal Brake-Resistor, a type may be selected from the following list External and internal Brake-Resistors will be switched in parallel. The internal and external performance-Data may be added in this case.	acc. to data in 1.3.3: internal resistor: Cont. Power Pd = 30W Peak Power Pmax = 1700W Required: Pd = 9,3W Pmax = 405W Result: The internal capability is sufficient																																						
selection guide external brakeresistors	<table border="1"> <thead> <tr> <th>drive-type</th> <th>Ub-setpoint</th> <th>Pmax ext[W]</th> <th>Pd ext [W]</th> <th>Rb ext [Ohm]</th> <th>Parker - type</th> </tr> </thead> <tbody> <tr> <td rowspan="3">637FD6Rxx3</td> <td>DC 375V</td> <td>4260</td> <td>100</td> <td>33</td> <td>B100/33-3</td> </tr> <tr> <td>DC 375V</td> <td>17150</td> <td>300</td> <td>8,2</td> <td>B300/8,2-3</td> </tr> <tr> <td>DC 375V</td> <td>17800</td> <td>560</td> <td>7,9</td> <td>B560/7,9-3</td> </tr> <tr> <td rowspan="3">637FD6Rxx7</td> <td>DC 730V</td> <td>5330</td> <td>100</td> <td>100</td> <td>B100/100-6</td> </tr> <tr> <td>DC 730V</td> <td>16150</td> <td>300</td> <td>33</td> <td>B300/33-6</td> </tr> <tr> <td>DC 730V</td> <td>20400</td> <td>560</td> <td>26</td> <td>B560/26-6</td> </tr> </tbody> </table> <p>Overload-Capability: approx 5000% / 0,5 Sec</p>	drive-type	Ub-setpoint	Pmax ext[W]	Pd ext [W]	Rb ext [Ohm]	Parker - type	637FD6Rxx3	DC 375V	4260	100	33	B100/33-3	DC 375V	17150	300	8,2	B300/8,2-3	DC 375V	17800	560	7,9	B560/7,9-3	637FD6Rxx7	DC 730V	5330	100	100	B100/100-6	DC 730V	16150	300	33	B300/33-6	DC 730V	20400	560	26	B560/26-6
drive-type	Ub-setpoint	Pmax ext[W]	Pd ext [W]	Rb ext [Ohm]	Parker - type																																		
637FD6Rxx3	DC 375V	4260	100	33	B100/33-3																																		
	DC 375V	17150	300	8,2	B300/8,2-3																																		
	DC 375V	17800	560	7,9	B560/7,9-3																																		
637FD6Rxx7	DC 730V	5330	100	100	B100/100-6																																		
	DC 730V	16150	300	33	B300/33-6																																		
	DC 730V	20400	560	26	B560/26-6																																		

5.8.2 Configuration of the brake resistor

Possible ballast circuit configurations at digital devices.

a) Compact design

The plug-in modules of servo-control series 635/637/637+/637F are provided with an on board ballast electronics. It is intended for application as compact unit KDER resp. KD6R.

These compact units contain the necessary ballast resistor incl. fuse for the ballast circuit. Except KD6R16.. KD6R307 (external resistor only).

b) Rack design.

While the plug-in modules are used in a rack, the NEB power supply module takes dissipation of the braking energy (adjustment of ballast monitoring: please see NEB manual).

In this case the ballast electronics of the plug-in module will be deactivated with the configuration parameter "Ballast activate = N". All further ballast parameters are no longer relevant then.

r.g. a) Adjustment of ballast circuit for compact units:

1. Ballast electronics activated:

In this case the ballast electronics of the plug-in module will be activated. "Ballast activate = J".

2. Operating point:

The operating point has to be adjusted dependent on the voltage variant.

"Ucc Ballast on = 375 V" for 230 V AC supply

"Ucc Ballast on = 720 V" for 400..460 V AC supply

3. Resistance value:

As resistance value, the parallel resistance from internal and external resistance has to be adjusted.

4. Rated power:

As ballast power (braking energy), the sum total of internal and external resistor power has to be adjusted.

Precondition for correct monitoring of shunted ballast resistors is the nearly same ratio of P - cont. power to P - pulse power. This is guaranteed with the Parker standard combinations.

..KD6R16.. KD6R307 units do not contain an internal ballast resistor.

At these versions the values of the external resistor can be feed directly.

Example:

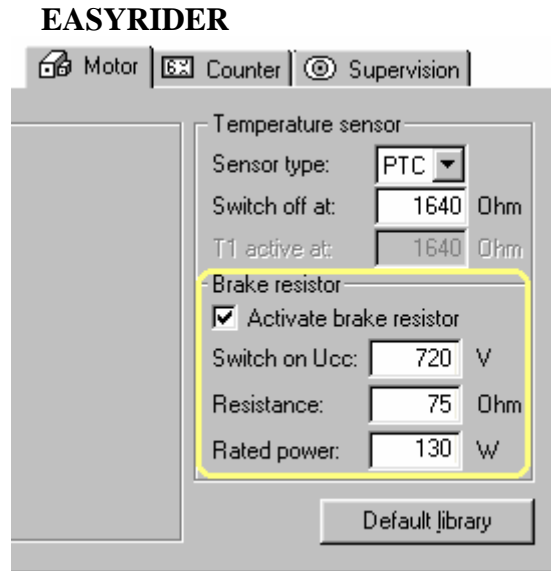

Evaluation resistance value in use of internal and external resistances.

Internal "Ballast resistances = 300 Ohm" for ..KD6R10
 External "Ballast resistances = 100 Ohm" for ..KD6R107

$$\text{formula : } \frac{1}{R_{\text{total.}}} = \frac{1}{R_{\text{int.}}} + \frac{1}{R_{\text{ext.}}}$$

$$\frac{1}{R_{\text{total.}}} = \frac{1}{300\Omega} + \frac{1}{100\Omega} \Rightarrow R_{\text{total.}} = 75\Omega$$

Set up resistance value = **75 Ohm**

Evaluation Ballst power in use of internal and external Ballast power.

Internal "Ballast power = 30 Watt" for ..KD6R10..-7
 External "Ballast power = 100 Watt" for ..KD6R10..-7

$$\text{formula : } P_{\text{total.}} = P_{\text{int.}} + P_{\text{ext.}}$$

$$P_{\text{total.}} = 30W + 100W \Rightarrow P_{\text{ges.}} = 130W$$

Set up rated power = **130 Watt**



Caution !

Placing of external brake resistors

Brake-resistor are dissipating heat !
 Make sure, that there will be no fire-danger in case of operating the resistor in nominal- or fail-conditions

6 Wiring Instructions

6.1 General Information

Digital servo drives are designed for **operation in metallic grounded enclosures**. For perfect operation as well as for observance of all regulations **the front board must be connected with the enclosure electrically and fixed**.

6.2 Control cabling

Recommended cross section 0,25 mm². The control signal lines must be laid separate from the power signal lines. (see chapter 6.7.1) The resolver cable must contain three shielded pairs **and** must be shielded as a whole. The shielding should be connected to the ground spread out on the drive side. We recommend using Parker resolver cable **KIR**. Cable for transmitting data are always to be laid shielded !

6.3 Power cabling

Recommended section according to rated current. Use only 75° Cu-cables.

6.4 Installation of the rack

When the rack is secured not in a hinged bay but on a mounting plate, it is recommended to do the wiring of the connections for the power connector X50 on the rear of the rack before installing. With hinged-bay installation, the customer must ensure that the parts sensitive to voltage such as the Ucc bus, mains supply lines, etc., are protected against electric shock.

6.5 Analog setpoint

The setpoint input is a differential input. Therefore the poling can be done depending on the requirements. Important: the setpoint voltage must be galvanically connected to the reference potential of the control connections (plug X10). It is possible to connect one pole directly to GND.

6.6 Safety rules



Caution !

Plug / unplug all modules only when Ucc (DC-BUS) is off, that is, the green LED on the power supply module is off and the discharge time > 3 minutes has elapsed. The user must ensure protection against accidental touching.

6.7 Electromagnetic compatibility (EMC)

Conformity in accordance with the EEC Directive 89/336/EEC has been evaluated using a reference-system, consisting of a compact type drive and a line-filter on mounting-plate, connected to an AC-synchronous motor.

Mainly responsible for EMC-emissions is the motor cable. So this has to be installed exceptional carefully. The layout of grounding is very important. Grounding has to be low-impedant for high frequencies. That means, all ground-connecting parts have to use area.

The measurements made are valid under the use of Parker - cables, suppression aids and line filters and by application of the following wiring instructions:

6.7.1 Hints for mounting

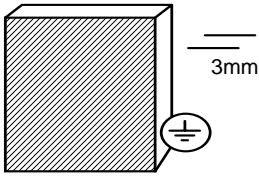
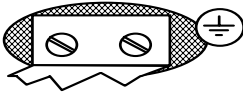
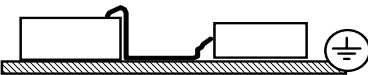
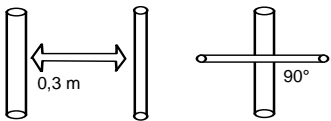
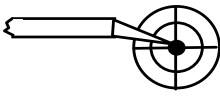
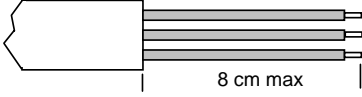
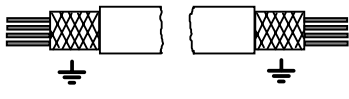
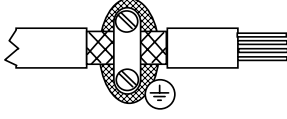
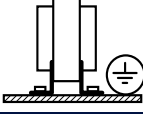
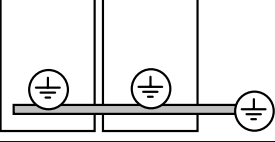
A	All components are mounted inside of a steel control cubicle on a mounting plate (thickness min. 3mm). Recommended: Galvanizing	
B	The connection between drive housing filter-housing and mountig-plate must be blank and not reduced by varnish. All screws must be well fixed !	
C	Use only Parker-filters and cables for motor and resolver	
D	Place all wires and cables as close as possible to any grounded metal parts	
E	Separate power- and control cables. Minimum distance: 0,3m crosspoints: 90°	
F	Avoid cable-loops. Especially the line between line-filter and drive has to be as close and short as possible (drilled)	
G	Maintain screen as close as possible to the cable-end (max distance 8 cm)	
H	Connect screen-connections according to general view of connetions, see chapter 2.1. Ground screens on both sides, shortest way. For long cables: Connect additional screen-area along the way	
I	Connect screens area-contacted to good grounded points	
K	Connect unused wires in cables to ground	
L	Install control cables directly close to grounded metal-parts or screend when leaving the control-cubicle	
M	Take care for good grounding of control-transformer (DC 24V). Use transformer with metal-socket and take care for conductive contact to mounting-plate	
N	Take care for good general grounding of the complete system. Interconnect several mounting-plates with copper-rails or copperband. Take care for ground connection between control-cubicle and machine !	

6 Wiring Instructions

6.7.2 Example for mounting

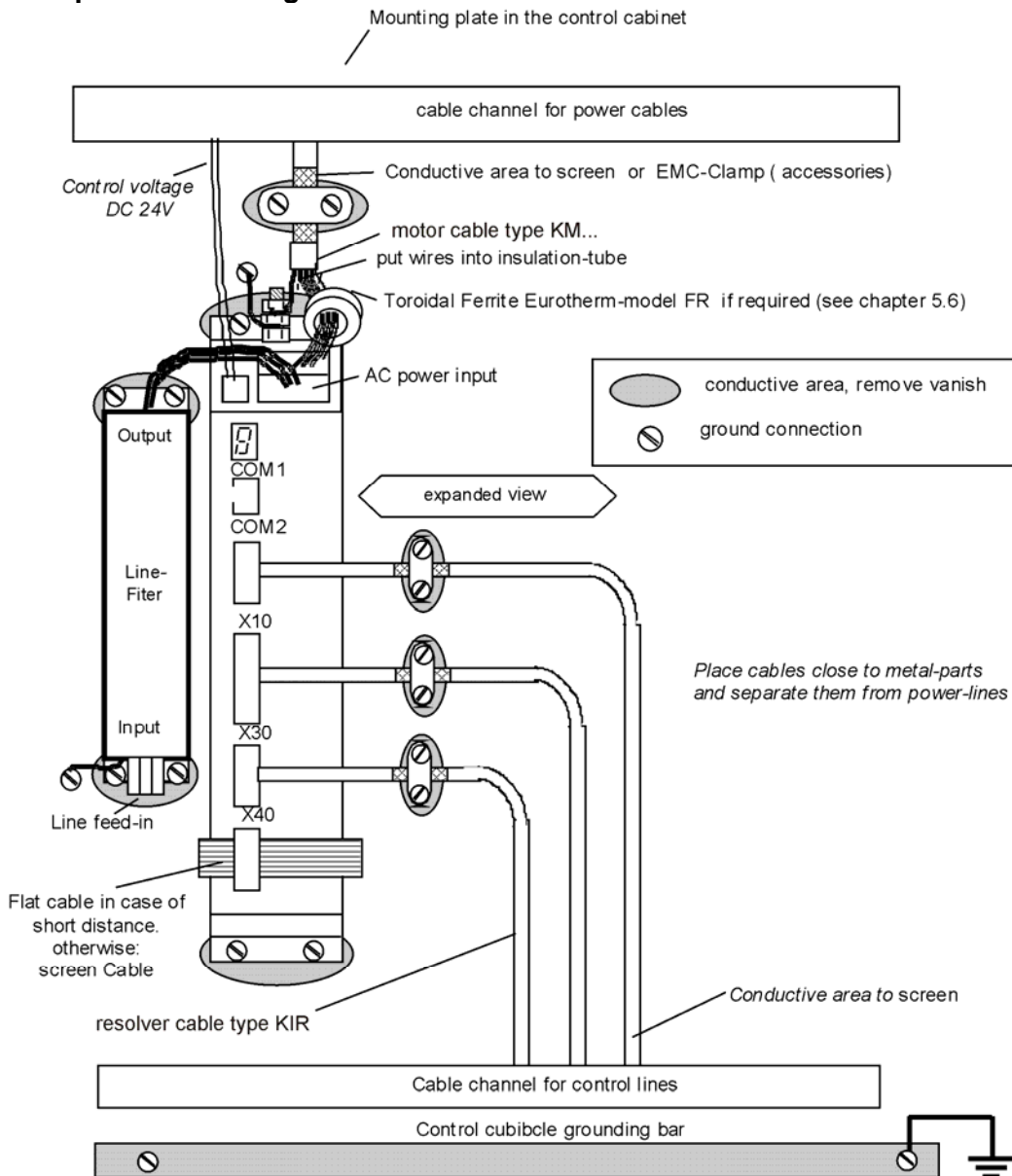

6.7.3 Achievable specifications and conditions

			Standard	conditions		additional conditions	
	Area	Category		Motor-cable length	Filter	Mounting	Additional
Emissions: transmitted by cable or by air	First Environment	C1	EN 61800-3	see chapter 5.6	LNF S/E LNF B	closed cabinet with ≥ 15 dB attenuation	toroidal ferrite cores see chapter 5.6
		C2					
Interference immunity: (≅ radiation) transmitted by cable or by air	Second Environment	-	EN 61800-3	-	-	-	-

7.1 Jumper

All jumpers are set to a standard position in production !

Layout of the Jumpers **see:** Chapter 1.2.3

JP100, bridged pad...	
2 and 3 (standard)	READY contact with reference to common output supply voltage on X10.21
1 and 3	READY contact can be wired freely

JP101, bridged pad...	
2 and 3 (standard)	Analog input X10.19 without internal Pull-up.
1 and 3	Analog input X10.19 with internal Pull-up to +12 V (FRR compatible)

JP102, bridged pad...	
2 and 3 (standard)	X10.23 = active ok. output
1 and 3	X10.23 = GND internal (FRR compatible)

JP1, JP2 bridged pad...	adjust identically !
2 and 3 (standard)	X10.15 = high-active
1 and 3	X10.15 = low-active

JP3, JP4 bridged pad...	adjust identically !
2 and 3 (standard)	X10.14 = high-active
1 and 3	X10.14 = low-active

JP2.8, JP2.3 JP2.7, JP2.2	
open	Default, RP CAN, RP DEV, RP PDP RP 2CA, RP 2C8
close	RP 232, RP 422, RP 485, RP IBS, RP EA5, RP SUC

JP209 2-3 JP209 1-3	
close	Default RP SBT
Further connecting configuration see: Product Manualo 07-02-10-02-E-Vxxxx RP_SBT	

7.2 Digital communication

see: Chapter 13

8 Commissioning



Caution !

Wiring errors or incompatible operation may cause unpredictable motions. Avoid danger for man and machine !

8.1 Preparation

- For PC-link use the Parker communication software EASYRIDER® Windows - Software. For the start, we suggest exercises in simulation mode to get familiar with EASYRIDER. This chapter presumes the knowledge how to handle EASYRIDER. Suggestions: Use test equipment to train yourself. EASYRIDER® Windows - Software contains interactive HELP - functions.
- For security-reasons the access to several functions is blocked by password. Commissioning has to be executed by trained staff only.
- Users may have their application-adapted commissioning methods when familiar with the product, on their own responsibility.
- The system must be in accordance with all valid safety specifications. The function of all safety equipment (limit-switches for example) have to be checked.
- To activate the power-stage of the drive, the "ACTIVE"-signal (X10.22 against X10.9) has to be exited.

Hint: With the assembly of the option module SBT you kindly note the extended functions of the signals (see documentation 07-02-10-02-E..)

8.2 Commissioning in steps

Step	Action	Remark	
1	Before switching on Check the wiring, especially: Filter polarity, supply Motor wiring, motor polarity Resvolver wiring, polarity (or other feedback systems)		
2	With critical mechanical part: remove motor shaft from application	avoid danger	
3	Connect PC by RS232 link to the drive service port COM1 and start EASYRIDER®		
4	Set up state NOT ACTIVE	7-segment-dispay	
	635/ 637/ 637+/ 637f ¹⁾ X10.22 against X10.9	631 X10.7 against X10.4	
	Power on		
5	Switch on control voltage	7-segment-dispay	
	635/ 637/ 637+/ 637f Us = 24V DC	631 Us = 230V AC	
	EASYRIDER® communicates (see diagnosis F9)		
6	Are parameters already evaluated?		
	Yes: load parameter-file xxx.WDD. Store parameters in the drive. If existent: load BIAS-file xxx.WBD and store in drive. Proceed with 10 or 15 (experts)		
7	Menu Commissioning: Select the used motor from the EASYRIDER®- Library Adjust max. current to nominal motor current or smaller	reduced torque	
8	When leaving that menu: Tuning-parameters for current loop will be calculated and offered to the user. Normally, these values give dynamic servo motion.	Confirm acceptance of offered parameters	
9	Store data power-fail-save in the drive		
10	Menu: Tuning speed loop		

¹⁾ **Hint:** With the assembly of the option module SBT you kindly note the extended functions of the signals (see documentation 07-02-10-02-E..)

8 Commissioning

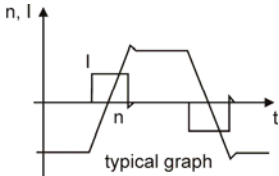
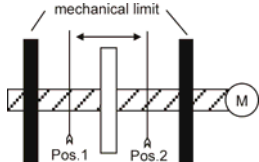
Step	Action	Remark
11	"ACTIVE" switched	7-segment-dispay 
12	Adjust test generator as required. Activate test generator with "START F8". Activate graph to display motor current or speed. Can be optimize manually (P- and I- gain)	
13	Is the result ok? Yes: continue with 14 No: continue with U1	
14	Preparation to the position controller The commissioning of the position controller is first recommended without linked mechanics. In the case of secure function, the mechanics can then be linked up.	
15	Power OFF. Connect motor-shaft to application Move application to a free area between mechanical limits. Power ON. Menu: Tuning position loop	
16	Adjust test generator. Select Pos. 1 and Pos. 2 to uncritical value. Select slow speed and low acceleration first, rise up later	mind: reaction-time- to Emergency stop
17	"ACTIVE" – switched. Every activation of "START F8" excites a motion form Pos. 1 to Pos 2 and with next activation, form Pos. 2 to Pos. 1	
18	Observe the behaviour of application and graph. Optimize tuning-parameters (P-, I- and V gain)	
19	Is the result ok? Yes: continue with 20 No: continue with 9	
20	Basic power-up is done now. Further functions (Interfaces, fieldbus functions, synchronizing and so on may be done adapted to selected equipments	
21	Select the menu "File" store parameters" and store the data in the drive, protect against lost, with F7-key	data save

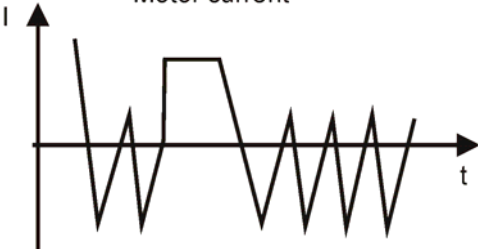
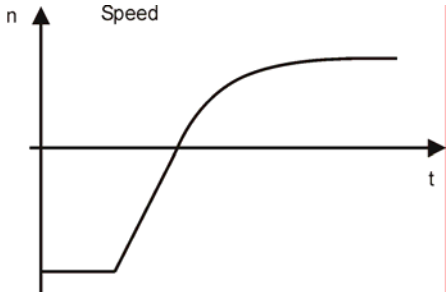
Step	Action	Remark
U1.1	<p>Menu: Tuning Speed Loop</p> <p>Stable parameters are calculate bases on the system data; and can be called up with “Default value”. Sometimes it is recommended to make further manual tuning.</p> <p>Rated value can be soured either digital by the internal generator or analogue by</p> <p style="margin-left: 20px;">635/ 637/ 637+/ 637F 631 +/- 10V at X10.5/18 +/- 10V at X10.1/2</p> <p>ATTENTION! Too hard tuning will cause current-ripple and high power dissipation.</p>	<p style="text-align: center;">Motor current</p>  <p>P- gain too high or I-time constant too small Motor noise</p>
U1.2	<p>Too weak adjustment cause slow loops reactions that may cause problems for the tuning of position loops.</p>	<p style="text-align: center;">Speed</p>  <p>P- gain too small or I-time constant too high</p>
U1.3	<p>It the result ok?</p> <p>Yes: continue with 9</p>	<p>No: continue with U2.1</p>
U2.1	<p>Menu: Tuning Current Loop</p> <p>Stable parameters are calculated bases on the system data and can be called up with “default value” Manual tuning may be useful.</p> <p>Rated value can be soured either digital by the internal generator or analogue by</p> <p style="margin-left: 20px;">635/ 637/ 637+/ 637F 631 +/- 10V at X10.5/18 +/- 10V at X10.1/2</p> <p>ATTENTION! Tuning of current loops should be only done after consultation of Parker experts. continue with 9</p>	

9 Diagnosis and Trouble-Shooting

9.1 7-Segment Display











Many sources of faults can be narrowed down with the diagnosis display.

Display (Code) ⁴	Explanation Comment	Output		Servo Drive			
		Ready	Warning ²⁾	631	635	637F/638	
	00h	no display	off	off	<input checked="" type="checkbox"/>	<input checked="" type="checkbox"/>	<input checked="" type="checkbox"/>
		any control voltage? external fuses ok?					
	03h	system ready for operate	on	off	<input checked="" type="checkbox"/>	<input checked="" type="checkbox"/>	<input checked="" type="checkbox"/>
		drive ready, not active					
	01h	drive active and ready for operate!	on	off	<input checked="" type="checkbox"/>	<input checked="" type="checkbox"/>	<input checked="" type="checkbox"/>
		DC link voltage within the limits, power stage active, fault-free					
	12h	internal STOP with serial deactivating	off	off	<input checked="" type="checkbox"/>	<input checked="" type="checkbox"/>	<input checked="" type="checkbox"/>
		activate drive via serial interface					
	82h	drive of serial interface (bus interface) deactivated !	off	off	<input checked="" type="checkbox"/>	<input checked="" type="checkbox"/>	<input checked="" type="checkbox"/>
		only if bus interface is integrated					
	90h	deactivated with delay time for the brake			<input checked="" type="checkbox"/>	<input checked="" type="checkbox"/>	<input checked="" type="checkbox"/>
		deactivated via input.	on	off			
		deactivated via serial command.	off	off			
	92h	Active input is activated with switching on 24 V control voltage	off	off	<input checked="" type="checkbox"/>	<input checked="" type="checkbox"/>	<input checked="" type="checkbox"/>
		switch enable X10.xx switch on 0 V and after that 24 V			X10.7	X10.22	X10.22
	46h	Under voltage of control voltage	off	off	<input type="checkbox"/>	<input checked="" type="checkbox"/>	<input checked="" type="checkbox"/>
		Power supply switched on? Power supply o.k ? internal fuse o.k.? control voltage < 17 V					
	60h	Under voltage in DC-bus < Ua low threshold	off	off	<input checked="" type="checkbox"/>	<input checked="" type="checkbox"/>	<input checked="" type="checkbox"/>
		check power supply (power supply unit, wiring, fuse), check under voltage parameter					
	DAh	feedback system error (e.g. resolver)	off	off	<input checked="" type="checkbox"/>	<input checked="" type="checkbox"/>	<input checked="" type="checkbox"/>
		wiring to encoder system ok? encoder system supply ok?					
	F2h	I ² t- overload of the drive	¹⁾	¹⁾	<input checked="" type="checkbox"/>	<input checked="" type="checkbox"/>	<input checked="" type="checkbox"/>
		does the control loop oscillate? P-amplification too high mechanics stiff? requirements too high? is warning /8/ evaluated?					
	66H	I ² t overload of the motor	¹⁾	¹⁾	<input checked="" type="checkbox"/>	<input checked="" type="checkbox"/>	<input checked="" type="checkbox"/>
		does the control loop oscillate? P-amplification too high mechanics stiff? requirements too high? is warning /8/ evaluated?					

Display (Code) ⁴	Explanation Comment	Output		Servo Drive			
		Ready	Warning ²⁾	631	635	637F/638	
	B6h	over temperature of the output stage (> 90°C)	1)	1)	<input checked="" type="checkbox"/>	<input checked="" type="checkbox"/>	<input checked="" type="checkbox"/>
		adequate cooling of the drive? ambient temperature too high?					
	3Eh	over voltage on DC bus	1)	1)	<input checked="" type="checkbox"/>	<input checked="" type="checkbox"/>	<input checked="" type="checkbox"/>
		ballast module ok? adequate ballast module?					
	E0h	chassis shorting and short circuit due to hardware	aus	aus	<input checked="" type="checkbox"/>	<input checked="" type="checkbox"/>	<input checked="" type="checkbox"/>
		motor cabling ok? digital-loops setup ok? short circuit to chassis in the motor? braking resistor: ohm- value too low? try to start fresh! send in for repair					
	FEH	WARNING! Overload of the drive I²t or motor I²t or temp.-output stage too high. If no reaction within approx. 3sec.it switches off with signals /3/, /4/ or /5/. Signal /8/ clears when there is no more danger or it is switched off	ein	1)	<input checked="" type="checkbox"/>	<input checked="" type="checkbox"/>	<input checked="" type="checkbox"/>
		mechanics stiff? defective bearings; cold grease? reduce requirements and creep to next possible STOP					
	F6h	over temperature motor(NTC/PTC)	aus	1)	<input checked="" type="checkbox"/>	<input checked="" type="checkbox"/>	<input checked="" type="checkbox"/>
		check overload of the motor / cooling etc.					
	2Eh	motor temperature too high	ein	1)	<input checked="" type="checkbox"/>	<input checked="" type="checkbox"/>	<input checked="" type="checkbox"/>
		check overload of the motor / cooling etc.					
	80h	ballast active	ein	aus	<input checked="" type="checkbox"/>	<input checked="" type="checkbox"/>	<input checked="" type="checkbox"/>
		Brake energy is removed					
	38h	Warning: I²t ballast too high	ein	ein	<input checked="" type="checkbox"/>	<input checked="" type="checkbox"/>	<input checked="" type="checkbox"/>
		ballast resistance usage >90%					
	7Ch	switch off ballast	aus	aus	<input checked="" type="checkbox"/>	<input checked="" type="checkbox"/>	<input checked="" type="checkbox"/>
		ballast resistance overloaded					
	6Ch	X 300 – Module not inserted or wrong inserted or defect	aus	aus	<input type="checkbox"/>	<input type="checkbox"/>	<input checked="" type="checkbox"/>
		X 300 testing					
	6Eh	X 300 – setting wrong	aus	aus	<input type="checkbox"/>	<input type="checkbox"/>	<input checked="" type="checkbox"/>
		X 30 / X40 Counter-Configuration test in the EASYRIDER® Windows – Software					
	1Ch	tracking window exceeded 3)	ein		<input checked="" type="checkbox"/>	<input checked="" type="checkbox"/>	<input checked="" type="checkbox"/>
		only in operation mode position control, will be deleted with the next run-command					

9 Diagnosis and Trouble-Shooting

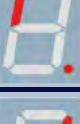
Display (Code) ⁴	Explanation Comment	Output		Servo Drive		
		Ready	Warning ²⁾	631	635	637F/638
	1Eh tracking error with switch off	on	off	<input checked="" type="checkbox"/>	<input checked="" type="checkbox"/>	<input checked="" type="checkbox"/>
	only in operation mode "position control"					
	20h limit switch + 3)	on	off	<input checked="" type="checkbox"/>	<input checked="" type="checkbox"/>	<input checked="" type="checkbox"/>
	limit switch + X10.xx on 0 Volt, from Firmware 6.16					
	08h limit switch - 3)	on	off	<input checked="" type="checkbox"/>	<input checked="" type="checkbox"/>	<input checked="" type="checkbox"/>
	limit switch - X10.xx on 0 Volt, from Firmware 6.16 3)					
	9Eh limit switch + / limit switch -	on	off	<input checked="" type="checkbox"/>	<input checked="" type="checkbox"/>	<input checked="" type="checkbox"/>
	both limit switch X10.xx on 0 Volt, from Firmware 6.16					
	76h memory-checksum-error	off	off	<input checked="" type="checkbox"/>	<input checked="" type="checkbox"/>	<input checked="" type="checkbox"/>
	try new start, store the value again					
	62h DC Bus Unterspannung < 100 V			<input checked="" type="checkbox"/>	<input type="checkbox"/>	<input type="checkbox"/>
	-	off	off	<input checked="" type="checkbox"/>	<input checked="" type="checkbox"/>	<input checked="" type="checkbox"/>
	1: internal software error, Watchdog					
	2: blinking: BIAS software error	on	off	<input type="checkbox"/>	<input type="checkbox"/>	<input checked="" type="checkbox"/>
	1: Firmware version check					
	2: Bias program error fix					
	starting lockout RP SBT with 637f starting lockout STO1 and STO2 with 638					
	Terminal X290. 3/4 check with 637f Terminal X11. 1/4 check with 638	off	off	<input type="checkbox"/>	<input type="checkbox"/>	<input checked="" type="checkbox"/>
	STO1 und STO2 Signale Difference > 20 Seconds					
	Switch Off /On Control Voltage	on	off	<input type="checkbox"/>	<input type="checkbox"/>	<input checked="" type="checkbox"/>
	X10.22 Quickstop Ramp active					
	42h X10.22 low high slope missing	on	off	<input type="checkbox"/>	<input type="checkbox"/>	<input checked="" type="checkbox"/>
	2Ah Max. speed overload	off	off	<input type="checkbox"/>	<input type="checkbox"/>	<input checked="" type="checkbox"/>
	check speed limits resp. setpoint speed					
	1Eh tracking error with switch off	on	off	<input checked="" type="checkbox"/>	<input checked="" type="checkbox"/>	<input checked="" type="checkbox"/>
	only in operation mode "position control"					

Display (Code) ⁴	Explanation Comment	Output		Servo Drive		
		Ready	Warning ²⁾	631	635	637F/638
 4Ah	CAN - Open 402 Sync Message error in Interpolated positioning mode -	on	off	<input checked="" type="checkbox"/> 6.19c	<input type="checkbox"/>	<input checked="" type="checkbox"/> 8.19d
 9Ch	SSI – Encoder Error -	on	off	<input type="checkbox"/>	<input type="checkbox"/>	<input checked="" type="checkbox"/> 8.21
 9Ch	CAN-BUS Error Flashing display Noise on bus or lane missing!	on	off	<input type="checkbox"/>	<input type="checkbox"/>	<input checked="" type="checkbox"/> 8.33
 CEh	Profibus-Module Error	on	off	<input type="checkbox"/>	<input type="checkbox"/>	<input checked="" type="checkbox"/> 8.31
 ECh	Warning:setpoint current maximum limit reached and no actual current measurement (check motor connection)	on	off	<input type="checkbox"/>	<input type="checkbox"/>	<input checked="" type="checkbox"/> 8.34
 30h	638 Active Delay time runs	on	off	<input type="checkbox"/>	<input type="checkbox"/>	<input checked="" type="checkbox"/> 638 only
 8Eh	638 SAFETY- Parameter Ram Error	off	off	<input type="checkbox"/>	<input type="checkbox"/>	<input checked="" type="checkbox"/> 638 only
 C4h	638 X300 xM Module, Memory Error Firmware, Alteracode and Parameters missing	off	off	<input type="checkbox"/>	<input type="checkbox"/>	<input checked="" type="checkbox"/> 638 only with X300 xM-Module
 44h	638 X300 xM Module, Memory Error Alteracode and Parameter- and BIAS-Data missing	off	off	<input type="checkbox"/>	<input type="checkbox"/>	
 04h	638 X300 xM Module, Memory Error Alteracode missing	off	off	<input type="checkbox"/>	<input type="checkbox"/>	
 40h	638 X300 xM Module, Memory Error Parameter- and BIAS-Data missing	off	off	<input type="checkbox"/>	<input type="checkbox"/>	

- 1) Reaction to these errors **chapter: “[Function diagrams from inputs and outputs](#)”**
- 2) With configuration corresponding **chapter: “[Operating modes and pin functions](#)”**
- 3) Operating mode “Position Control” only
- 4) The display code you can get with the serial command „internal diagnosis 2“ (0x26) in byte 16.

The error signals are shown as long as there is control voltage (Us), also when the power (DC-Bus) is switched off for safety reasons.

9 Diagnosis and Trouble-Shooting

9.2 Reset of a drive trouble

A general precondition for correct execution of the Reset is the elimination of the error cause.



Possible error signals



The error signals of the drive can be reset via:

1. **Control voltage OFF/ON,**
2. **the serial command “Drive Reset“ 0x02**
The host login must be occurred.
The drive must be deactivated via the serial command “deactivate Drive“ 0x00.
3. **the fieldbus-command “ Drive Reset“ 0x16 (22 decimal)**
The host login must be occurred via the BUS command 0x01. The drive must be deactivated via the BUS command “deactivate Drive“ 0x14.
The fieldbus command “Drive Reset“ with constant repetition of the fieldbus command 0x16 will be works-off only once.
For further processing, it is necessary, meanwhile to send another control word (e.g. 0 status order).
4. **Viva 0 – 1 flank on input X10.11**
Precondition:
 - The input X10.11 is with function 1“Reset drive fault“ configured (EASYSRIDER® Windows – Software)
 - There is no host login.
 - The input Active,(X10.22) is inactive (0V) ¹⁾
 - The signal must be present min. 250 ms
5. **Viva 0 – 1 flank on input X120.1**
Precondition:
 - The input X120.1 is with function 1“Reset drive fault“ configured (EASYSRIDER® Windows – Software)
 - There is no host login.
 - The input Active,(X10.22) is inactive (0V) ¹⁾
 - The signal must be present min. 250 ms

Notice !!

After remove of the tracking error deactivation  the warning message  (tracking error) is active up to the next move command.

The **error signal**  (releasing before ready) can be reset by deactivation the drive.

¹⁾ **Hint:** With the assembly of the option module SBT you kindly note the extended functions of the signals (see documentation 07-02-10-02-E..)

9.3 Trouble shooting

The following list refers to faults which can occur during operation.

Display:



Error	Explanation and remedy	
no motor run despite current flow	motor mechanically blocked? motor brake released?	1)
motor runs unevenly	check setpoint wiring check grounding and shielding too high P-amplification in the speed controller reduce value (with EASYRIDER® setting/speed control) too small I-time in the speed controller? reduce value (with EASYRIDER® setting/speed control)	
no reaction of setpoint progression, despite torque in standstill	Limit switch functions effective (BIAS)	
no current flow; no torque despite activating the drive correctly	motor cables interrupted? Is input "I extern" (X10.19) activated (config. menu) and not notched up? limit switch - input activated and not notched up?	
Interference symptoms with power frequency	Ground loops in setpoint or actual value wiring? Shieldings laid on both sides? Signal cables near high voltage cables?	
Motor takes up preferred positions after activation	Position encoder or motor cables with reversed poles? Resolver or Feedback- encoder incorrectly adjusted? Number of motor poles wrong matching? (config. menu)	1)
Motor runs up immediately after activation although there is no setpoint	Motor cables or feedback- cables reversed? Encoder incorrectly adjusted? (e.g. Resolver)	1)
Motor reaches in idling cycle very different speed when running to the right or to the left	Feedback-Encoder incorrectly adjusted (e.g. Resolver)	

1) Display



or



mostly short after activating; before warning



10 Block Circuit Diagram

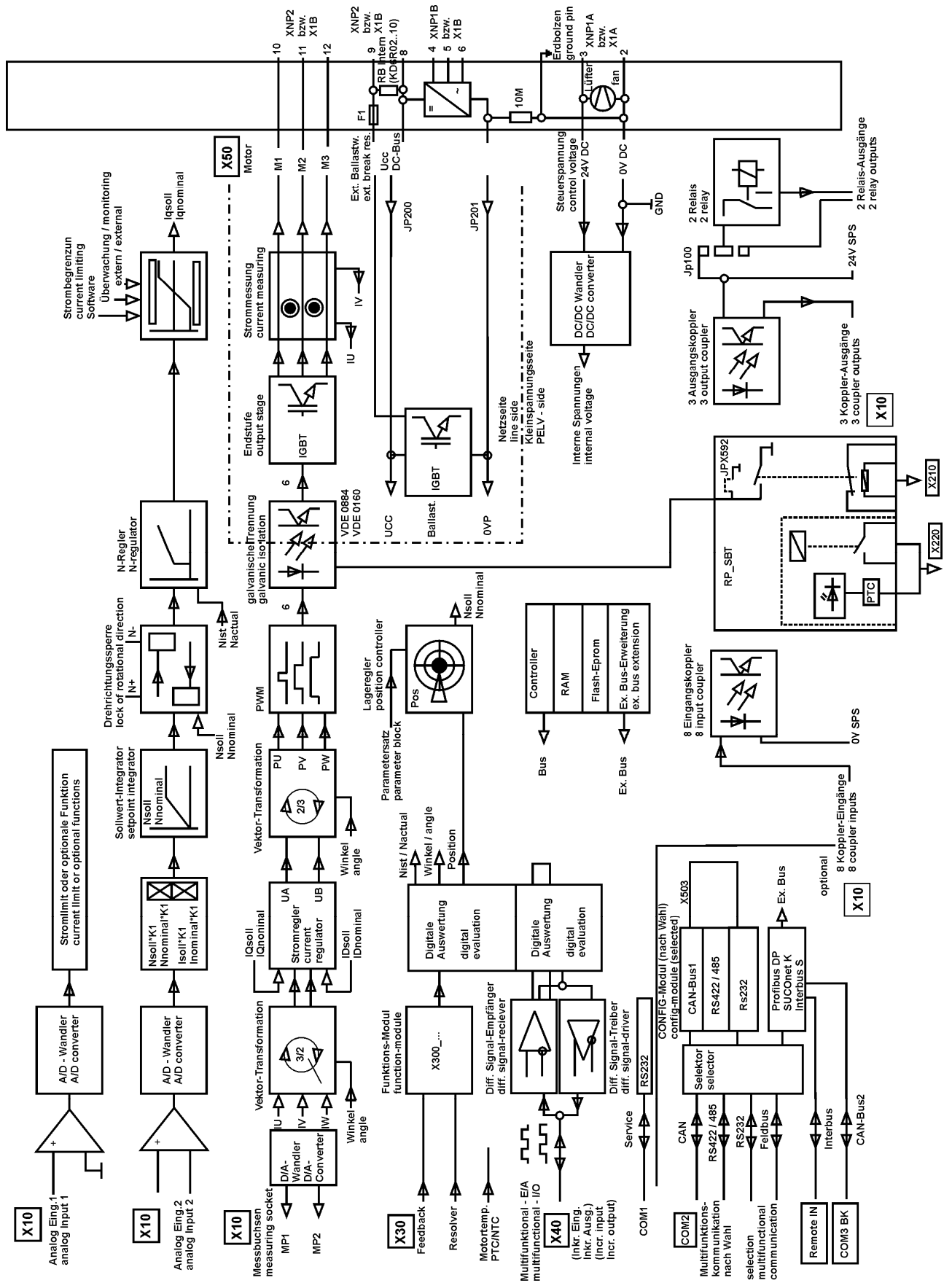

11.1 Power circuit

galvanic separation from control circuit	in acc. with EN 50178 / VDE 0160
specification in accordance with	UL 508C and cUL
short circuit and to frame proof for	Min. 2000 releasings
overvoltage monitoring D6R...-3	Max. 400V DC ±5V DC
overvoltage monitoring D6R...-7	Max. 765V DC ±10V DC
undervoltage monitoring	min. 15V DC; configurable
overtemperature switch off at	95 ° C +/- 5%
clock frequency	4,75 kHz
frequency of current ripple	9,5 kHz

11.2 Control circuit

galvanic separation from power circuit	in acc. with EN 50178 / VDE 0160
further information:	see concept of insulation chapter 1.3.1
	see data compact units chapter. 1.3.3
	see data plug-in modules chapter 1.3.4

11.3 Signal inputs and outputs, connection X10

additional galvanic separation from power and control circuit		
nominal voltage of the in- and outputs	24 V DC	
number of outputs signal outputs via OPTO coupler	5 $U_{max} = 45V DC;$ $I = 0..60 mA;$ short circuit proof, resistive load	
signal outputs via RELAY	$U_{max} = 45V DC;$ $I = 1\mu A...1,2A$	
contact protection with inductive load	internal varistor	
number of inputs signal outputs via OPTO coupler	8 $L = 0...7 V DC$ or open $H = 15...30 V DC$ $I_{in} 24VDC: 8 mA$	
Shortest time of signal at all input to accept the signal in an application:	> 1 ms	
Damping of the transfer from low to high (0-->24V):	fast input: 20µs (X10.4, X10.25)	Damping of the transfer from low to high (0-->24V):
Interrupt response time for fast input	10µs (X10.4, X10.25)	
Damping of the transfer from high to low (24-->0V)	fast input: 250µs (X10.4, X10.25)	Damping of the transfer from high to low (24-->0V)

11 General Technical Data

11.4 Signal inputs and outputs, connection X120B resp. 120C

additional galvanic separation from power and control circuit																
nominal voltage of the in- and outputs	24 V DC +20% / -10%															
number of outputs signal outputs via OPTO coupler	4 resistive load I _{max.} = 2A inductive loadmax. 1Henry <table style="margin-left: auto; margin-right: auto;"> <tr> <td style="text-align: center;">I_{out}</td> <td style="text-align: center;">I_{out}</td> <td style="text-align: center;">I_{out}</td> </tr> <tr> <td style="text-align: center;">1A</td> <td style="text-align: center;">1A</td> <td style="text-align: center;">1A</td> </tr> <tr> <td style="text-align: center;">1A</td> <td style="text-align: center;">1A</td> <td style="text-align: center;">1A</td> </tr> <tr> <td style="text-align: center;">0,33A</td> <td style="text-align: center;">0,33A</td> <td style="text-align: center;">0,33A</td> </tr> <tr> <td style="text-align: center;">0,2A</td> <td style="text-align: center;">0,2A</td> <td style="text-align: center;">0,2A</td> </tr> </table> short-circuit current limited by (5A) over-temperature protection, active overvoltage clamping (50V); keyed	I _{out}	I _{out}	I _{out}	1A	1A	1A	1A	1A	1A	0,33A	0,33A	0,33A	0,2A	0,2A	0,2A
I _{out}	I _{out}	I _{out}														
1A	1A	1A														
1A	1A	1A														
0,33A	0,33A	0,33A														
0,2A	0,2A	0,2A														
number of inputs signal outputs via OPTO coupler	4 L = 0...7 V DC or open H = 15...30 V DC I _{in} at 24VDC: 8 mA															
Shortest time of signal at all input to accept the signal in an application:	> 1 ms															
Damping of the transfer from low to high (0-->24V):	default input: 200µs															
Damping of the transfer from high to low (24-->0V)	default input: 1000µs															

11.5 Digital control

current control	
Loop-Cycle-Time	105 µs
settings	according to factory specifications or motor data
current limits, Adjustment by:	speed control -menue Analog Input 0..10V = 0..100%; can be normed, 10Bit

speed control	
Loop-Cycle-Time	105 µs
settings	speed control menue
differential setpoint input analog resolution (including sign)	U _{Soll} = 10 V, can be normed; R _i = 10k 14 bit
digital setpoint input	via interfaces

position control	
Loop-Cycle-Time	105 µs

11.6 Digitale communication

RS232 - service interface	COM1 19200 baud, 8 databits, 1 startbit, 1 stopbit, parity: even
<u>Optional</u> RS232 / RS422 / RS 485 on SUB D – socket	COM2
CAN1, Profibus DP, SUCOnet K on SUB D – socket Interbus S on SUB D – socket (OUT)	
Interbus S (Remote IN) CAN2	additional on SUB D – socket

11.7 Resolver evaluation/transmitter principle

<u>General:</u> The specified data refer to the combination of the standard resolver interface with Function-Module X300_RD2; operated with the Parker resolver R 21-T05, R15-T05	
carrier frequency	$f_t = 4,75 \text{ kHz}$
ripple of the speed actual value signal	2% ¹⁾
max. position resolution for one revolution	65536 / 16 bit
absolute position accuracy	+/- 0,7 ° ¹⁾
relative position accuracy	+/- 0,08 ° ¹⁾

¹⁾ Data under check, Reality: Quality improved

11.8 Controllsystem

system run-up time after switching on the control voltage	max. 6 sec.
data memory / organization	Flash Eprom 256 KB RAM 64 KB; EEPROM 96 kByte

11 General Technical Data

11.9 Analog-Outps

measuring pin X10.17

signal range	-10V.....0.....+10V magnifier function can be normed
resolution	10 bit, independend of norming
internal resistance	1,8 kOhm

measuring pin X10.6

signal range	-10V.....0.....+10V magnifier function can be normed
resolution	8 bit, independend of norming
internal resistance	1,8 kOhm

11.10 Thermal data

thermal data	see chapter 1.3
--------------	-----------------

11.11 Mechanical data

dimensions	see chapter 1.4
weight	see chapter 1.3

Further data you will find in chapter 1.3

The digital servo drive consists of different materials.

The following table shows, which materials can be recycled and which have to be disposed of in a special way.

material	recycle	disposal
Metal	yes	no
plastics material	yes	no
printed board assembly	no	yes

Dispose of the appropriate materials in accordance with the valid environmental control laws.

13 Software

13.1 EASYRIDER® Windows - Software

EASYRIDER® Windows - Software is an comfortable tool to use all drive functions. Detailed Online-Help-information's and instruction are available.

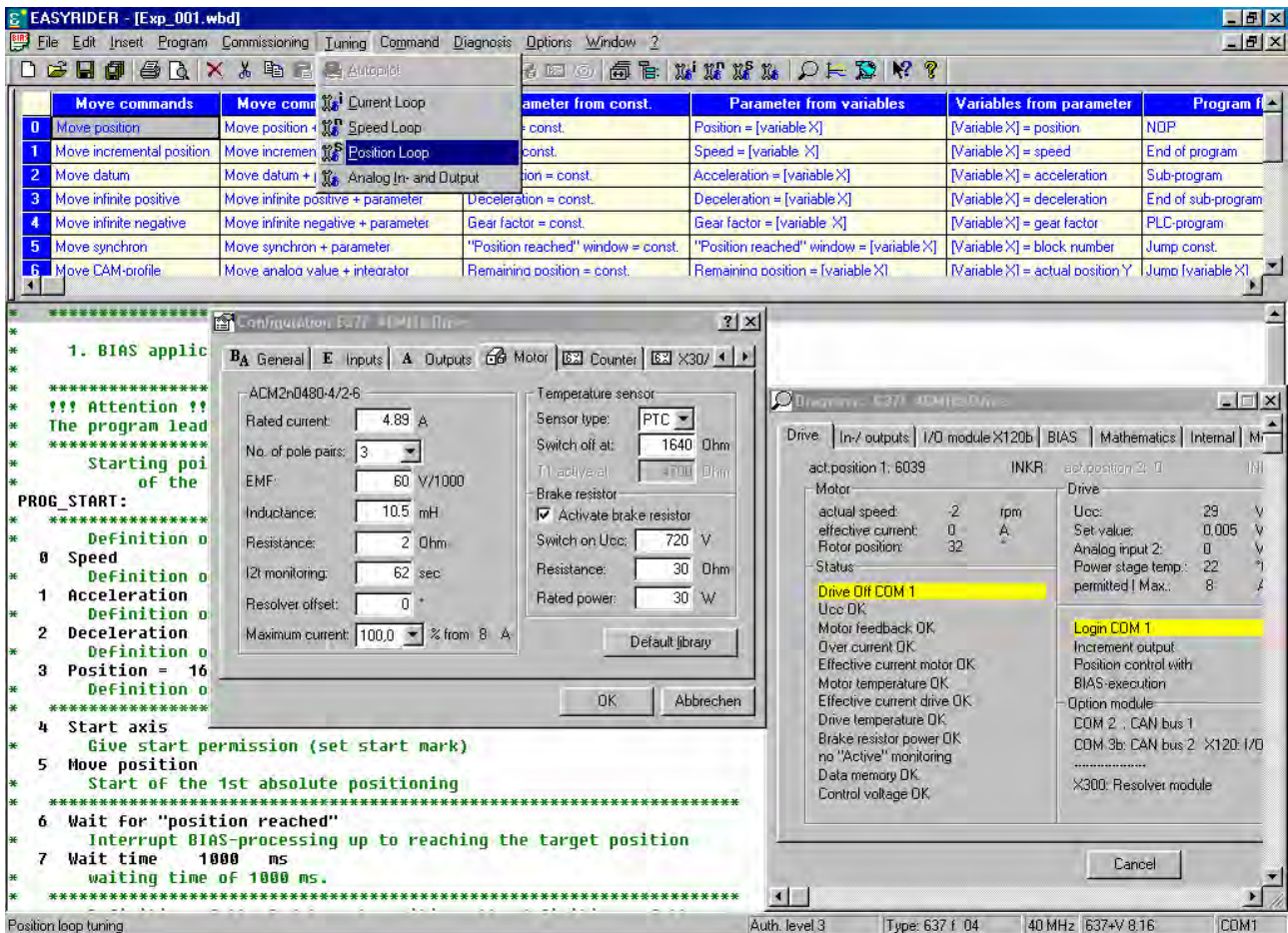

EASYRIDER® Instructions: (extract)

- Autopilot-function as interactive tutorial
- System identification
- BIAS - instruction-set editor
- Oscilloscope-function
- start-up and commissioning-tools
- Setting of parameters, Setting of configurations
- Servo-diagnostics, Interface diagnostics, Fieldbus diagnostics
- Motor library
- save system data in file, load system data from file
- send system data to servo drive, save system data in servo drive
- load system data from servo drive

Important:

Edited data in EASYRIDER® are transmitted to the RAM of the servo drive and **active after** use of the instruction **SEND**. **Only the instruction SAVE in EEPROM** writes data into a not volatile memory. Data are stored there power-fail save.

13.2 Parker programming language BIAS

In **Operating mode 5** – Position control with BIAS, three user-defined programs can be executed parallel. The BIAS-program and the PLC-program (sequence cascades, 1 command per position controller sampling = 844 μ s) as well as the Mathematics program (cyclic execution in remaining time of processor).

The BIAS-program is primary intended for administration of travel commands. If application permits, also simple calculations can be performed and analog/digital I/O's can be serviced in this task. The PLC-task is conceived to perform I/O logic, sequence control, monitoring and CAN-Bus communication. The Mathematics program is designed for complex calculations, e.g. computing of a cam, executed by the BIAS-program afterwards. But it is also possible to store the same tasks here, as basically defined for PLC-task, which can increase PLC performance of the 637F drive approx. twenty times.

While the BIAS-program will be executed from the start block directly after activation of **operating mode 5**, the PLC-program will be first started by BIAS-command "PLC-program" and the Mathematics program by command "Mathematics program". At reaching the command "End of program" (Mode = 0) the respective execution pointer re-jumps to his start label. Within the command set the following command groups are provided:

Program flow control

- Fixing start/end of main- and sub-programs
- Conditional and unconditional jump commands

Travel relevant commands

- Positioning commands
- Parameter commands
- Technology functions
 - >Register positioning
 - >PID-control
 - >Synchronous applications

Logic commands

- Logic commands for coils and internal relays

Variable commands

- Writing and reading of parameters
- Fundamental operations of arithmetic with long integer
- Type-conversions long integer \Leftrightarrow double float (Math.task only)
- Fundamental operations of arithmetic with double float (Math.task only)
- SIN(x), COS(x), SQRT(x) with double float (Math.task only)
- Writing and reading of synchronous profile tables.

CAN-Bus commands

- Communication with other Parker products

13 Software

The user has the possibility to program his sequence himself from this set of commands.

Available program area	
Set number	
0000 -	
...	
...	can be selected via
...	data inputs X10.xx
...	max. to block no. 63 and
...	and Strobe X10.2
...	
0063 -	
...	
...	
1499	last block

The BIAS operation set is listed on the next page. You can read the exact function of the individual commands in the help function of the EASYRIDER® Windows -Software in the BIAS editor or in the BIAS command description (10-06-05-E-Vxxxx).

13.3 BIAS – Commands

Position = const.	[Variable X] = position	BIAS-execution pointer	[Variable X] = flag Y	Profile value = [variable X]	Save table	PLC-program
This command is only permitted in the BIAS- task	This command is only permitted in the BIAS, PLC and MATH-Task	This command is only permitted in the PLC and MATH-Task	This command is only permitted in the BIAS and PLC -Task	This command is only permitted in the MATH-Task	This command is only permitted in the MATH-Task	This command is only permitted in the BIAS and MATH-Task

	0	1	2	3			7	8	9	A	B	
0	Move position	Move position + parameter	Position = const.	Position = [variable X]	[Variable X] = position	NOP	Flag X = const.	If input X ? const.	[Variable X] = const.	Mathematic program	Table [[variable X]] = const.	[D Variable X] = [D Variable Y] + [D Variable Z]
1	Move incremental position	Move incremental position + parameter	Speed = const.	Speed = [variable X]	[Variable X] = speed	End of program	If flag X ? const.	If output X ? const.	If [variable X] ? const.	Profile initialization = const.	Table [[variable X]] = [Y Variable Z]	[D Variable X] = [D Variable Y] - [D Variable Z]
2	Move datum	Move datum + parameter	Acceleration = const.	Acceleration = [Variable X]	[Variable X] = acceleration	Sub-program	Flag X = flag Y	Output X = const.	[Variable X] = [variable Y] + const.	Profile cycle length = [variable X]	[X Variable Y] = Table [[variable Z]]	[D Variable X] = [D Variable Y] * [D Variable Z]
3	Move infinite positive	Move infinite positive + parameter	Deceleration = const.	Deceleration = [variable X]	[Variable X] = deceleration	End of Sub-program	Flag X = input Y	Output X = flag Y	[Variable X] = [variable Y] - const.	[Variable X] = profile value	[W Variable X] = [Y Variable Z]	[D Variable X] = [D Variable Y] / [D Variable Z]
4	Move infinite negative	Move infinite negative + parameter	Gear factor = const.	Gear factor = [Variable X]	[Variable X] = gear factor	PLC-program	Flag X = output Y	_____	[Variable X] = [variable Y] * const.	Profile value = [variable X]	[X Variable Y] = const.	If [D Variable X] ? [D Variable Y]
5	Move synchron	Move synchron + parameter	"Position reached" window = const.	"Position reached" window = [variable X]	[Variable X] = block number	Jump const.	Flag X = flag Y & flag Z	_____	[Variable X] = [variable Y] / const.	_____	[Variable [X]] = const.	[D Variable X] = SIN ([D Variable Y])
6	Move CAM profile	Move analogue value + integrator	Remaining position = const.	Remaining position = [variable X]	[Variable X] = actual position Y	Jump [variable X]	Flag X = flag Y flag Z	_____	[Variable X] = flag Y	_____	[Variable [X]] = [variable Y]	[D Variable X] = COS ([D Variable Y])
7	Synchronous settings 1	Move speed + integrator	Ramp filter = const. [variable X]	Maximal current = [variable X]	[Variable X] = analogue input Y	BIAS-Execution pointer = const.	Flag X = flag Y ^ flag Z	_____	[Variable X] = [variable Y].bit Z number	Save table	[Variable [X]] = [variable Y]	[D Variable X] = SQRT ([D Variable Y])
8	Synchronous settings 2	_____	Actual position X = const.	Actual position X = [variable Y]	[Variable X] = latch position Y	Wait for "position reached"	Flag X = ! flag Y	IBT- mask number = const.	[Variable X] = [variable Y]	_____	[Variable X] = [variable Y] ? [variable Z]	_____
9	Move PID: speed	_____	If actual position X ? const.	Analogue output X = [variable Y]	[Variable X] = actual speed Y	Wait time = const.	Flag X = status Y	IBT- notification number = const.	If [variable X] ? [variable Y]	_____	[Variable X] = [variable Y] ? const.	_____
A	Move PID: torque	Cycle length = const.	If actual position X ? [variable Y]	PID scaling	[Variable X] = latch status Y	Wait time = [variable X]	If status X ? const.	CAN Command = [variable X]	[Variable X] = [variable Y] + [variable Z]	_____	_____	_____
B	Set point [axis no.] = const.	Cycle length = [variable X]	Sensor window = const.	Sensor window = [variable X]	[Variable X] = position Y; axis no.	BIAS-execution pointer = [variable X]	Modus X = const.	IBT- data transfer	[Variable X] = [variable Y] - [variable Z]	_____	_____	_____
C	Set point [axis no.] = [variable X]	Load parameter set X = [variable [Y]]	Sensor position = const.	Sensor position = [Variable X]	[Variable X] = value Y	Jump [Var.[X]]: length = const.; from	Flag X = [variable Y]	CAN2 Command = [variable X]	[Variable X] = [variable Y] * [variable Z]	_____	_____	_____
D	Move relative	_____	Sensor adjustment 1 = const.	Sensor adjustment 1 = [variable X]	[Variable X] = axis status, axis no. Y	Execute X commands	[Variable X]. bit [Y] = const.	_____	[Variable X] = [variable Y] / [variable Z]	_____	_____	_____
E	Start axis	_____	Sensor adjustment 2 = const.	Sensor adjustment 2 = [variable X]	_____	_____	If [Var. X]. bit Y == const. then jump	_____	[Teachvariable X] = [variable Y]	_____	_____	_____
F	Stop axis	Stop axis + parameter	Update parameter	PID parameter	_____	Virtual program	Axis state, axis no. X, bit Y = const., [flag Z]	_____	[Variable X] = [teachvariable Y]	_____	_____	_____

- [Command group "Move commands"](#)
- [Command group "Parameter commands"](#)
- [Command group "Variable commands"](#)
- [Command group "Flag commands"](#)
- [Command group "Conditional jump commands"](#)

- [Command group "Program control commands"](#)
- [Command group "Mathematic commands"](#)
- [Command group "Output commands"](#)
- [Command group "CAN- Commands"](#)
- [Command group "637f commands"](#)



VDE Prüf- und Zertifizierungsinstitut

ZEICHENGENEHMIGUNG MARKS LICENCE

SSD Drives GmbH
Im Sand 14
76669 Bad Schönborn-Langenbrücken

ist berechtigt, für ihr Produkt /
is authorized to use for their product

**Gerät, sonstiges
Other appliance
Kompakt-Servoregler**

die hier abgebildeten markenrechtlich geschützten Zeichen
für die ab Blatt 2 aufgeführten Typen zu benutzen /
the legally protected Marks as shown below for the types referred to on page 2 ff.



Geprüft und zertifiziert nach /
Tested and certified according to

DIN EN 50178 (VDE 0160):1998-04; EN 50178:1997



VDE Prüf- und Zertifizierungsinstitut
VDE Testing and Certification Institute
Zertifizierungsstelle
Certification

Aktenzeichen: 1923500-3990-0003 / 19496

File ref.:

Ausweis-Nr. 108336

Blatt 1

Licence No.

Page

Weitere Bedingungen siehe Rückseite und Folgeseiten /
Further conditions see overleaf and following pages

Offenbach, 1998-07-02

(letzte Änderung/updated 2004-11-12)

VDE VERBAND DER ELEKTROTECHNIK
ELEKTRONIK INFORMATIONSTECHNIK e.V.



VDE Prüf- und Zertifizierungsinstitut Zeichengenehmigung

Ausweis-Nr. / Blatt /
Licence No. / page
108336 / 2

Name und Sitz des Genehmigungs-Inhabers / *Name and registered seat of the Licence holder*
SSD Drives GmbH, Im Sand 14, 76669 Bad Schönborn-Langenbrücken

Aktenzeichen / *File ref.* 1923500-3990-0003 / 19496 / FG13 / EN
letzte Änderung / *updated* Datum / *Date*
2004-11-12 1998-07-02

Dieses Blatt gilt nur in Verbindung mit Blatt 1 des Zeichengenehmigungsausweises Nr. 108336.
This supplement is only valid in conjunction with page 1 of the Licence No. 108336.

Gerät, sonstiges *Other appliance* Kompakt-Servoregler

Typ(en) / *Type(s)*:

637/K D6R02.S3-3
637/K D6R02.S3-7
637/K D6R04.S3-3
637/K D6R04.S3-7
637/K D6R06.S3-3
637/K D6R06.S3-7
637/K D6R10.S3-3
637/K D6R10.S3-7
637/K D6R16.S3-3
637/K D6R16.S3-7
637/K D6R22.S3-3
637/K D6R22.S3-7
637/K D6R30.S3-3
637/K D6R30.S3-7

Nennspannung 1/N/PE 230 V oder 3PE AC 230 V;
Nominal Voltage 50/60 Hz (S3-3 Typen)
3/PE AC 460 V; 50/60 Hz (S3-7 Typen)

Nennstrom siehe Anlage Nr. 1
Rated current see Appendix No. 1

zulässige Umgebungstemperatur 0...40°C
Ambiant temperature

Schutzmaßnahme Schutzklasse I
Protection against electric shock Class I

Fortsetzung siehe Blatt 3 /
continued on page 3

VDE Testing and Certification Institute * Institut VDE d'Essais et de Certification

Merianstrasse 28, D-63069 Offenbach



Telefon +49 (0) 69 83 06-0
Telefax +49 (0) 69 83 06-555

VDE Prüf- und Zertifizierungsinstitut Zeichengenehmigung

Ausweis-Nr. / Blatt /
Licence No. / page
108336 / 3

Name und Sitz des Genehmigungs-Inhabers / *Name and registered seat of the Licence holder*
SSD Drives GmbH, Im Sand 14, 76669 Bad Schönborn-Langenbrücken

Aktenzeichen / *File ref.*
1923500-3990-0003 / 19496 / FG13 / EN

letzte Änderung / *updated* Datum / *Date*
2004-11-12 1998-07-02

Dieses Blatt gilt nur in Verbindung mit Blatt 1 des Zeichengenehmigungsausweises Nr. 108336.
This supplement is only valid in conjunction with page 1 of the Licence No. 108336.

Schutzart	Einbaugerät, die Servoregler sind ausschließlich zur Speisung von Eurotherm (oder von Eurotherm freigegeben) Servomotoren bestimmt.
<i>Degree of protection</i>	<i>Built in devise, the servo controller are used only for Eurotherm servo motors or released from Eurotherm if others.</i>
Überspannungskategorie <i>overvoltage category</i>	III
Kurzschlussfestigkeit <i>Short circuit protection</i>	bedingt kurzschlußfest <i>conditionally short-circuit-proof</i>
Transformator <i>Transformer</i>	Fa. J. Lasslop, Typ TIV2DER Az.: 19235-3990-0002 Fa. Pulse FEE Typ MTA 12358 Fa. J. Lasslop, Typ T1 TEX-E V5
Weitere Angaben <i>Further information</i>	vergleiche Anlagen Nr. 1 und 2. <i>see Appendix No. 1 and 2.</i>
Beim Einbau	des genehmigten Erzeugnisses, der entsprechend der zugehörigen Installationsanleitung zu erfolgen hat, ist darauf zu achten, daß alle Anforderungen gemäß der oben genannten Bestimmung(en) eingehalten sind.
<i>Built-in</i>	<i>When the certified product is build in, installation must be in accordance to the provided installation instructions and requirements of the referenced standards must be assured</i>

Fortsetzung siehe Blatt 4 /
continued on page 4

VDE Testing and Certification Institute * Institut VDE d'Essais et de Certification

Merianstrasse 28, D-63069 Offenbach



Telefon +49 (0) 69 83 06-0
Telefax +49 (0) 69 83 06-555

VDE Prüf- und Zertifizierungsinstitut Zeichengenehmigung

Ausweis-Nr. / Licence No.	Blatt / page
108336	4

Name und Sitz des Genehmigungs-Inhabers / *Name and registered seat of the Licence holder*
SSD Drives GmbH, Im Sand 14, 76669 Bad Schönborn-Langenbrücken

Aktenzeichen / <i>File ref.</i>	letzte Änderung / <i>updated</i>	Datum / <i>Date</i>
1923500-3990-0003 / 19496 / FG13 / EN	2004-11-12	1998-07-02

Dieses Blatt gilt nur in Verbindung mit Blatt 1 des Zeichengenehmigungsausweises Nr. 108336.
This supplement is only valid in conjunction with page 1 of the Licence No. 108336.

Dieser Zeichengenehmigungs-Ausweis bildet die Grundlage für die EG-Konformitätserklärung und CE-Kennzeichnung durch den Hersteller oder dessen Bevollmächtigten und bescheinigt die Konformität mit den genannten Normen im Sinne der **EG-Niederspannungsrichtlinie 73/23/EWG** mit ihren Änderungen.

This Marks Licence is the basis for the EC Declaration of Conformity and the CE Marking by the manufacturer or his agent and shows the conformity with the said standards as defined by the EC Low-Voltage Directive 73/23/EEC including amendments.

VDE Prüf- und Zertifizierungsinstitut
VDE Testing and Certification Institute
Zertifizierungsstelle
Certification

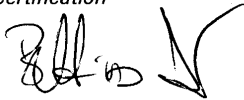

VDE Testing and Certification Institute • Institut VDE d'Essais et de Certification

Merianstrasse 28, D-63069 Offenbach



Telefon +49 (0) 69 83 06-0
Telefax +49 (0) 69 83 06-555

EC Declaration of Conformity

Issuer's name and address:

SSD Drives GmbH
Im Sand 14
76669 Bad Schönborn-Langenbrücken

Product:

Other appliance

Type designation:

637/K D6R02.S3-3; 637/K D6R02.S3-7; 637/K
D6R04.S3-3; 637/K D6R04.S3-7; 637/K D6R06.S3-3;
637/K D6R06.S3-7; 637/K D6R10.S3-3; 637/K
D6R10.S3-7; 637/K D6R16.S3-3; 637/K D6R16.S3-7;
637/K D6R22.S3-3; 637/K D6R22.S3-7; 637/K
D6R30.S3-3; 637/K D6R30.S3-7

The designated product is in conformity with the European Directive:

**73/23/EEC
including amendments**

"Council Directive of 19 February 1973 on the harmonization of the laws of the Member States relating to electrical equipment designed for use within certain voltage limits".

Full compliance with the standards listed below proves the conformity of the designated product with the provisions of the above-mentioned EC Directive:

DIN EN 50178 (VDE 0160):1998-04; EN 50178:1997

The VDE Testing and Certification Institute (EU Identification No. 0366), Merianstr. 28, D-63069 Offenbach, has tested and certified the product granting the VDE Licence for the mark(s) as displayed.



Licence No.

108336

File Reference

1923500-3990-0003 / 19496 FG13 / EN

Bad Schönborn

22.11.04

(Place, Date)

ppa. C. G. G.

(Legally binding signature of the issuer)

Lined area for notes, consisting of a large rectangular frame with horizontal lines inside.

16 Modification Record

Version	Modification	Chapter	Date	Name	Comment
V0103	-	-	02.06.03	N. Dreilich	new
V0204	text correction new functions connection X30 additional In-/Outputs Pin assignment for Interbus S correction safety module SBT Text addition for SBT 7-segment display new BIAS commands	1.2 2.1-2.1.1 2.4.2 2.6.2.1 2.6.2.9 2.5.5 2.7 9.1-9.2 13.3	 16.03.04	 N. Dreilich	photo page 29-30 correction text addition "COM3 B" page 36 page 46-47 page 12-13/25-27/ 44-45/50-51/65-66 /72 new options
V03004	SSD Drives	-	19.10.2004	N.Dreilich	Logos
V0405	diverse correction (text, design and photos)	all	12.05.2005	N. Dreilich	
V0505	Model code, extended		18.05.2005	N. Dreilich	
V06007	Parker new options CCA / CC8 / PC8/ Type code for JDE		19.12.2007	N. Dreilich	Logos



We reserve the right to make technical changes. The data correspond to the current status at the time of printing.

Parker Hannifin GmbH & Co. KG
Electromechanical & Drives
Automation Group
Im Sand 14
D-76669 Bad Schönborn
Tel. +49(0) 7253/9404-0
Fax +49(0) 7253/9404-99
sales.automation@parker.com

Parker Hannifin GmbH & Co. KG
Electromechanical & Drives
Automation Group
Robert-Bosch-Straße 22
D-77656 Offenburg
Tel. +49(0) 781/509-0
Fax +49(0) 781/509-98176
sales.automation@parker.com

Parker Hannifin GmbH & Co. KG
Electromechanical & Drives
Automation Group
Von-Humboldt-Straße 10
D-64646 Heppenheim
Tel. +49(0) 6252/7982-0
Fax +49(0) 6252/7982-05
sales.automation@parker.com



www.parker-automation.com